



**A36 11L.UAS.76**  
**Urban Air Mobility Study: Safety Standards, Aircraft  
Certification, and Impact on Market Feasibility and Growth  
Potentials**

October 10<sup>th</sup>, 2022

## **NOTICE**

This document is disseminated under the sponsorship of the U.S. Department of Transportation in the interest of information exchange. The U.S. Government assumes no liability for the contents or use thereof. The U.S. Government does not endorse products or manufacturers. Trade or manufacturers' names appear herein solely because they are considered essential to the objective of this report. The findings and conclusions in this report are those of the author(s) and do not necessarily represent the views of the funding agency. This document does not constitute FAA policy. Consult the FAA sponsoring organization listed on the Technical Documentation page as to its use.

## **LEGAL DISCLAIMER**

The information provided herein may include content supplied by third parties. Although the data and information contained herein has been produced or processed from sources believed to be reliable, the Federal Aviation Administration makes no warranty, expressed or implied, regarding the accuracy, adequacy, completeness, legality, reliability or usefulness of any information, conclusions or recommendations provided herein. Distribution of the information contained herein does not constitute an endorsement or warranty of the data or information provided herein by the Federal Aviation Administration or the U.S. Department of Transportation. Neither the Federal Aviation Administration nor the U.S. Department of Transportation shall be held liable for any improper or incorrect use of the information contained herein and assumes no responsibility for anyone's use of the information. The Federal Aviation Administration and U.S. Department of Transportation shall not be liable for any claim for any loss, harm, or other damages arising from access to or use of data or information, including without limitation any direct, indirect, incidental, exemplary, special or consequential damages, even if advised of the possibility of such damages. The Federal Aviation Administration shall not be liable to anyone for any decision made or action taken, or not taken, in reliance on the information contained herein.

## TECHNICAL REPORT DOCUMENTATION PAGE

<b>1. Report No.</b> A36 11L.UAS.76	<b>2. Government Accession No.</b>	<b>3. Recipient's Catalog No.</b>	
<b>4. Title and Subtitle</b> Urban Air Mobility Study: Safety Standards, Aircraft Certification, and Impact on Market Feasibility and Growth Potentials		<b>5. Report Date</b> October 2022	
		<b>6. Performing Organization Code</b> WSU, NCSU, MSU, and ERAU	
<b>7. Author(s)</b> Gerardo Olivares, WSU, NIAR Vincent Robinson, WSU, NIAR Hoa Ly, WSU, NIAR Guillermo Caro, WSU, NIAR Clyde Rinkinen, ERAU Chase Nicholas, NCSU Evan Arnold, NCSU Steve Bert, NCSU Christopher Boone, MSU		<b>8. Performing Organization Report No.</b>	
<b>9. Performing Organization Name and Address</b> National Institute for Aviation Research, Wichita State University, 1845 Fairmount St, Wichita, KS, 67260-0193. North Carolina State University, Raleigh, NC 27695-7103 Mississippi State University, Starkville, MS, 39762. Embry-Riddle Aeronautical University, 1 Aerospace Blvd., Daytona Beach, FL 32114		<b>10. Work Unit No.</b>	
		<b>11. Contract or Grant No.</b>	
<b>12. Sponsoring Agency Name and Address</b> Federal Aviation Administration FAA PM: Bhanu Kota FAA Sponsor: Dipasis Bhadra, Michael Lukacs, Kerin Olson, Francisco Capristan		<b>13. Type of Report and Period Covered</b> Final Report(October 2020–October 2022)	
		<b>14. Sponsoring Agency Code</b> 5401	
<b>15. Supplementary Notes</b>			
<b>16. Abstract</b> The vision to revolutionize mobility within metropolitan areas is a new frontier in aviation. Supporting accessible air transport systems for passengers and cargo by working with the urban air mobility (UAM) community to identify and address the opportunities and key challenges ahead is an emerging role for the Federal Aviation Administration (FAA). The UAM ecosystem and its associated technologies are likely among the most complex aviation ever encountered. To understand how the UAM environment could emerge and respond proactively, it is necessary to be informed by assessing and understanding the markets, viability, economics, and challenges that will arise. The research presented in this document highlights the challenges and needs of the FAA to support safe integration and could be used to assist decision-makers in allocating personnel and resources. The work presented in this report is divided into three working packages: Working Package 1 forecasts Urban Air Mobility (UAM) demand from 2022-2045. Working Package 2 classifies, investigates the applicability of current regulatory frameworks, and explores potential certification and development costs for UAM aircraft. Working Package 3 seeks to identify the impact of UAM on the National Airspace System concerning air traffic control, infrastructure, and operations.			
<b>17. Key Words</b> UAM, NAS, UTC, ATM, Certification, Crashworthiness, Market, Noise		<b>18. Distribution Statement</b>	
<b>19. Security Classification (of this report)</b> Unclassified	<b>20. Security Classification (of this page)</b> Unclassified	<b>21. No. of Pages</b> 414	<b>22. Price</b>

## **ACKNOWLEDGEMENTS**

The authors would like to thank all the Federal Aviation Administration (FAA) personnel involved in this research project. In particular, the authors would like to thank Dipasis Bhadra and Michael Lukacs for their contributions and invaluable input throughout the research. Additionally, the authors want to express thanks to Dr. Hua (Bill) He for guidance on vehicle noise and Fabio Grandi for input on vehicle certification.

We would also like to thank Christine DeJong from the General Aviation Manufacturers Association (GAMA) for her knowledge-sharing and expertise.

Lastly, the authors would like to thank Colonel Stephen P. Luxion, Hannah Thach, and LeighAlison Jones from the FAA's Center of Excellence for Uncrewed Aircraft Systems (ASSURE) for supporting this research.

## TABLE OF CONTENTS

NOTICE.....	1
LEGAL DISCLAIMER .....	2
TECHNICAL REPORT DOCUMENTATION PAGE .....	3
ACKNOWLEDGEMENTS.....	4
TABLE OF FIGURES .....	9
TABLE OF TABLES.....	14
TABLE OF ACRONYMS.....	16
EXECUTIVE SUMMARY .....	20
1 INTRODUCTION .....	24
2 EVALUATION OF UAM MARKET POTENTIAL: ECONOMIC FEASIBILITY, POTENTIAL SIZE AND GROWTH, CHARACTERISTICS OF POPULATION, AND GROUND INFRASTRUCTURE.....	26
2.1 Research Context.....	26
2.2 Market Analysis.....	26
2.2.1 Market Characteristics and Viability .....	26
2.2.2 Market Overview and Submarkets .....	29
2.2.3 Costs to Enter the Market .....	32
2.2.4 Ground Infrastructure Requirements .....	35
2.2.5 Competition for UAM Passenger Services .....	41
2.2.6 COVID-19 Related Impacts on UAM Passenger Markets.....	45
2.2.7 Market Segmentation Analysis .....	49
2.3 Estimating Demand 2022 – 2045 .....	65
2.3.1 Target Markets and Suitable Market Conditions .....	65
2.3.2 Potential Size and Growth of the UAM Passenger Market.....	76
2.3.3 Bass Model Analysis .....	77
2.3.4 Overall Demand Modeling Findings .....	90
2.4 References .....	93
2.5 Appendix A: UAM Passenger Market Supplemental Resources .....	116
2.5.1 Direct and Indirect Operational Cost Parameters and Assumptions .....	116
2.5.2 UAM Passenger Demand Validation – Cumulative Demand by Location.....	118
2.5.3 Other Guideposts Identified for Demand Validation .....	124
2.6 Appendix B: Site Suitability Analysis: Psychometric Validation and Site Segmentation.....	124

2.6.1	Site Suitability Analysis: Psychometric Validation - Additional References .....	136
2.6.2	Appendix: Suitability Scenario Results .....	137
2.7	Appendix C: Code for Bass Modeling .....	139
2.7.1	R Code for Bass Modeling .....	139
2.7.2	Overview of Data Merge Spreadsheet (AllDiffusionCurvesV2.xlsm).....	145
2.7.3	Data Merge Spreadsheet VBA Code (from Run Button).....	147
3	<b>AIRWORTHINESS REGULATIONS AND THEIR APPLICABILITY TO UAM AIRCRAFT CERTIFICATION .....</b>	<b>150</b>
3.1	Task I – UAM Classification .....	150
3.1.1	Overall Market .....	151
3.1.2	Top 10+ Vehicles Subset.....	172
3.1.3	UAM Classification Conclusions .....	187
3.2	Task II – Regulatory Standards Applicability .....	190
3.2.1	Regulatory Agencies Approach for UAM Type Certificate .....	191
3.2.2	eVTOL Crashworthiness .....	199
3.2.3	Battery Crashworthiness.....	203
3.2.4	Noise regulations and their applicability to UAM vehicles .....	212
3.3	Task III – UAM Program Cost Estimation .....	241
3.3.1	DAPCA IV .....	242
3.3.2	Eastlake Model.....	243
3.3.3	NASA Advanced Missions Cost Model.....	254
3.3.4	UAM Program Cost Estimation Conclusions .....	264
3.4	Conclusions.....	265
3.5	References .....	266
3.6	Appendix A: EVTOL Database.....	273
4	<b>EVALUATION OF UAM INTEGRATION ON THE NATIONAL AEROSPACE SYSTEM – AIR TRAFFIC CONTROL AND OPERATIONS.....</b>	<b>274</b>
4.1	Introduction .....	274
4.1.1	Introduction of common terms and their definitions .....	274
4.1.2	Introduction of UAM CONOPs .....	274
4.1.3	Research Gaps .....	275
4.1.4	Assumptions and Limitations.....	275
4.2	Research Questions .....	276
4.3	Summary of Literature Review .....	276

4.3.1	Proposed Timeline of AAM Development and Integration .....	277
4.3.2	Minimum System, Operational, and Procedural Requirements Necessary to Enable UAM Integration .....	277
4.3.3	Communication, Navigation, and Surveillance Requirements and Best Practices for UAM Integration .....	282
4.3.4	Impact of UAM Integration on Air Traffic Controller Workload .....	286
4.3.5	Infrastructure Requirements Necessary to Support UAM Integration into the NAS (including Terminal Environments) .....	286
4.3.6	Coordination of non-segregated operations between the UAM and non-UAM air traffic .....	289
4.3.7	Recent Industry Advances toward UAM Integration .....	290
4.3.8	Vertiport Design and Planning.....	291
4.4	Methodology .....	293
4.4.1	Standard KDAB Environment .....	293
4.4.2	UAM KDAB Environment .....	294
4.4.3	Simulation Environment Configuration .....	305
4.4.4	Experimental Design .....	306
4.4.5	Metrics .....	309
4.5	Experimental Results and Analysis .....	312
4.5.1	Results .....	312
4.5.2	Analysis .....	323
4.5.3	Recommended Experiment Improvements .....	325
4.6	Recommendations for UAM/NAS Integration .....	326
4.6.1	The minimum system, operational, and procedural requirements necessary to enable UAM integration .....	326
4.6.2	The Communication, Navigation, Surveillance (CNS) requirements/best practices necessary for UAM integration .....	327
4.6.3	The infrastructural requirements necessary to support UAS integration into NAS (including terminal environments)?.....	330
4.6.4	Existing strategies to coordinate non-segregated operations between the UAM and non-UAM air traffic .....	331
4.7	Conclusion .....	332
4.7.1	Key Findings .....	332
4.7.2	Recommendations for future work .....	334
4.8	References .....	335



4.9 Appendix A: Literature Review .....347

4.10 Appendix B: Institutional Review Board Materials .....348

## TABLE OF FIGURES

Figure 2.1. Advanced Passenger Mobility Growth Paradigm (Hussain and Silver, 2021).	27
Figure 2.2. OEMs and Their Associated Entry Into Service Dates (SMG Consulting, 2022).	28
Figure 2.3. Market Segments (UAM Geomatics, 2022).	29
Figure 2.4. Airport Shuttle Concept (Blade, 2022).	30
Figure 2.5. Initial Air Taxi Concept (Joby, 2021).	31
Figure 2.6. Initial Regional Air Mobility Concepts (Lilium, 2022).	32
Figure 2.7. Vertiports and Passenger Demand in Northern California (Rimjha et al. 2021).	40
Figure 2.8. Example Mode Choice Scenario Presented to Joby Survey Participants (Joby, 2021).	42
Figure 2.9. Revenue Forecasts - Before & During the Pandemic (UAM Geomatics, 2019-2021).	46
Figure 2.10. Maximum Range in Miles by Maturity.	56
Figure 2.11. Maximum Number of Passengers in Miles by Maturity.	57
Figure 2.12. Top Speed in Miles per Hour by Maturity.	58
Figure 2.13. Visual Segmentation of Vehicles with RAM Characteristics.	59
Figure 2.14. Scenario Analysis with Revenue in Billions for RAM.	61
Figure 2.15. UAM Passenger Market Launch Sites and Operator Headquarters.	66
Figure 2.16. Site Suitability Analysis Results (ASSURE A36, 2022)	74
Figure 2.17. Regression of Bass p (Innovation) Residual Plots.	82
Figure 2.18. Regression of Bass q (Imitation) Residual Plots.	84
Figure 2.19. Example Bass Output: Median p/Median q.	85
Figure 2.20. Merge Macro Input.	86
Figure 2.21. Los Angeles Annual Trips for Original and Smoothed Data Series.	87
Figure 2.22. Los Angeles Annual Trips for Smoothed and Aggregate pq Data Series.	88
Figure 2.23. Los Angeles Annual Trips for Smoothed Data Series and Different Delay Levels.	89
Figure 2.24. Projected Annual Passenger Trips Over Time.	91
Figure 2.25. AAM US Passenger Market Revenue Projections Over Time (Revenue in \$US Billions).	92
Figure 2.26. US AAM Passenger Flight Projections Over Time.	123
Figure 2.27. Cumulative Revenue by Use Case in US \$Billions (UAM Geomatics, 2021).	124
Figure 2.28. SSA Index Correlations.	126
Figure 2.29. Average Value of SSA Variables for Sites in Top 10 vs. non-Top 10.	127
Figure 2.30. PCA Scree Plot.	128
Figure 2.31. PCA Biplot.	129
Figure 2.32. Site Suitability Analysis Derived Dimensions.	131
Figure 2.33. Site Suitability Analysis Derived Dimensions on Log Scale.	132
Figure 2.34. Cluster Analysis using Ward's Method of top 25 Metros.	134
Figure 2.35. Summary of Factor 1 Market Potential Values.	135
Figure 2.36: The Run Sheet Macro	146
Figure 3.1. Vehicle breakdown by architecture.	154
Figure 3.2. Vehicle architecture characteristics.	154
Figure 3.3. Vehicle breakdown by type of propulsion system.	155
Figure 3.4. Vehicle breakdown by maturity level.	155
Figure 3.5. Vehicle breakdown by certification agency (planned by OEMs).	156

Figure 3.6. Intended section for Type Certificate by OEMs from (a) FAA and (b) EASA.....	156
Figure 3.7. Vehicle breakdown by maximum takeoff weight (MTOW) [lb]. .....	157
Figure 3.8. Vehicles per (a) primary and (b) secondary mission purpose. ....	158
Figure 3.9. Vehicle breakdown by autonomy level. ....	159
Figure 3.10. Vehicle breakdown by estimated total payload [lb]. ....	159
Figure 3.11. Vehicle breakdown by maximum cruise altitude above ground level (AGL) [ft]. .	160
Figure 3.12. Vehicle breakdown by maximum operating altitude mean sea level (MSL) [ft]. ...	161
Figure 3.13. Vehicle breakdown by cruise speed [mph]. ....	161
Figure 3.14. Vehicle breakdown by Endurance [hr]. ....	162
Figure 3.15. Vehicle breakdown by airframe material. ....	162
Figure 3.16. Vehicle breakdown by the number of lifting propellers, <i>p</i> . ....	163
Figure 3.17. Vehicle breakdown by the number of forward propellers, <i>fp</i> . ....	163
Figure 3.18. Vehicle breakdown by the number of coaxial propeller sets, <i>cp</i> . ....	164
Figure 3.19. Vehicle operation readiness by the target year. ....	164
Figure 3.20. Vehicle breakdown by type of landing gear. ....	165
Figure 3.21. Vehicle breakdown by the number of passengers. ....	165
Figure 3.22. Electric vehicle breakdown by type of battery. ....	166
Figure 3.23. Range [miles] vs. Estimated total payload [lb]. ....	167
Figure 3.24. Range [miles] vs. Number of Passengers. ....	168
Figure 3.25. Range [miles] vs. Cruise speed [mph]. ....	169
Figure 3.26. Range [miles] vs. Endurance [hr]. ....	171
Figure 3.27. Total number of UAM vehicle manufacturers per country. ....	172
Figure 3.28. Top vehicles – Architecture. ....	174
Figure 3.29. Top vehicles – Type of propulsion system. ....	174
Figure 3.30. Top vehicles – Maturity level. ....	175
Figure 3.31. Top vehicles – Certification agency. ....	176
Figure 3.32. Top vehicles – (a) FAA certification and (b) EASA certification. ....	176
Figure 3.33. Top vehicles – Maximum takeoff weight (MTOW) [lb]. ....	176
Figure 3.34. Top Vehicles – Mission Purpose (a) primary and (b) secondary. ....	177
Figure 3.35. Top vehicles – Autonomy level. ....	178
Figure 3.36. Top vehicles – Estimated total payload [lbs]. ....	178
Figure 3.37. Top vehicles – Maximum cruise altitude above ground level (AGL) [ft]. ....	179
Figure 3.38. Top vehicles – Maximum operating altitude mean sea level (MSL) [ft]. ....	179
Figure 3.39. Top vehicles – Cruise speed [mph]. ....	180
Figure 3.40. Top vehicles – Endurance [hr]. ....	180
Figure 3.41. Top vehicles – Airframe Material. ....	181
Figure 3.42. Top vehicles – Number of lifting propellers, <i>p</i> . ....	181
Figure 3.43. Top vehicles – Number of forward propellers. ....	182
Figure 3.44. Top vehicles – Number of coaxial propeller sets. ....	182
Figure 3.45. Top vehicles – Target operation year. ....	183
Figure 3.46. Top vehicles – Landing gear type. ....	184
Figure 3.47. Top vehicles – Number of passengers. ....	184
Figure 3.48. Top vehicles – Range vs. Payload. ....	185
Figure 3.49. Top vehicles – Range vs. Number of passengers. ....	186
Figure 3.50. Top vehicles – Range vs. Cruise Speed. ....	187

Figure 3.51. Top vehicles – Range vs. Endurance. ....	187
Figure 3.52. Number of vehicles vs. architecture (Top 10+ and other vehicles).....	188
Figure 3.53. ARI max and min per architecture (Top 10+). ....	189
Figure 3.54. Normalized variables for max. and min. vehicle architecture (Top 10+). ....	189
Figure 3.55. Normalized variables for max. and min. vehicle architecture (Top 10+ w/o Pipistrel Nuuva 300). ....	190
Figure 3.56. UAM architectures with respect to the traditional certification categories. ....	191
Figure 3.57. EASA’s MOC for special condition VTOL timeline. ....	194
Figure 3.58. Certification basis paths for eVTOLs. Adapted from (ASTM International, 2020). ....	195
Figure 3.59. Prescriptive vs. Performance-Based Rules. Adapted from (Thompson, 2018). ....	196
Figure 3.60. Example of the changes required in ASTM standards for FAA acceptance is provided in 87 FR 13911 (Federal Aviation Administration, 2022). ....	197
Figure 3.61. Example of the Side-by-Side view between the 14 CFR Part 23 Amdt. 23-64 to the ASTM standards, provided in 87 FR 13911 (Federal Aviation Administration, 2022). ....	197
Figure 3.62. 2019 Applicability of ASTM F44 Standards by Sub-Paragraph to eVTOL. Adapted from (Gunnarson, 2022). ....	198
Figure 3.63. Aviation sector committees (Gunnarson, 2022). ....	199
Figure 3.64. Ultimate load factors for (a) items of mass in the cabin and (b) occupants. Data collected from 14 CFR §§ 23.561 Amdt. 23-62 and 27.561 Amdt. 27-32.....	200
Figure 3.65. Emergency landing conditions: general considerations section from EASAs MOC SC-VTOL Issue 2 (European Union Aviation Safety Agency, 2021b). ....	201
Figure 3.66. Emergency landing dynamic conditions section from EASAs MOC SC-VTOL Issue 2 (European Union Aviation Safety Agency, 2021b). ....	201
Figure 3.67. Emergency conditions section from 14 CFR Part 23 § 23.2270 (Federal Aviation Administration, 2017b). ....	202
Figure 3.68. Comparison of survivable impact velocity changes for Army, Navy, and Civil rotorcraft. Obtained from (ASTM International, 2020). ....	203
Figure 3.69. Abuse tests for batteries as per different standards and regulations. Obtained from (Kotak et al., 2021). ....	204
Figure 3.70. Ultimate inertial load factors for energy storage systems in (a) cabin, (b) above or adjacent to the crew or passenger compartment, and (c) other areas. Data collected from CS- 27.952 Amdt. 6 and MOC SC-VTOL Issue 2.....	205
Figure 3.71. Schematic summary of the key components of a battery pack. Obtained from (European Commission et al., 2021). ....	206
Figure 3.72. Example of a crush textured platen for modules and packs as per (a) SAE J2464 (SAE International, 2021) and (b) SAND2017-6925 (Orendorff et al., 2017). ....	206
Figure 3.73. Microstructure of a celgard tri-layer separator (cross-section view). Obtained from (Avdeev et al., 2014). ....	211
Figure 3.74 Flow phenomena linked to various rotorcraft noise sources (Brentner, 2018). ....	214
Figure 3.75 Estimates of the percent of the population that would be highly annoyed based on DNL (Federal Interagency Committee on Noise, 1992). ....	217
Figure 3.76 Noise certification flight path for light, propeller-driven aircraft (Federal Aviation Administration, 2017a). ....	220

Figure 3.77 Part 36 Appendix G noise limits for propeller-driven light and commuter category airplanes with a MTOW of no more than 19,000 lb (8,168 kg) (Federal Aviation Administration, 2011).....	220
Figure 3.78 Part 36 test conditions for helicopters. Reproduced from (Federal Aviation Administration, 2011).....	222
Figure 3.79 Part 36 Appendix H noise limits for Stage 3 helicopters (Federal Aviation Administration, 2011).....	223
Figure 3.80 Appendix J noise limits for light helicopters with a MTOW of no more than 7,000 lb (3,125 kg) (Federal Aviation Administration, 2011).....	224
Figure 3.81 Bell XV-15 tiltrotor in hover (NASA, 1980).....	224
Figure 3.82 Appendix K noise limits for tiltrotors (Federal Aviation Administration, 2011). ...	225
Figure 3.83 Picture of Beta ALIA-250 during acoustic flyover tests (Greenwood, 2021). .....	231
Figure 3.84 Moog “SureFly” proof-of-concept electric multi-rotor UAM (Huff et al., 2021). ...	231
Figure 3.85 Microphone placement for testing performed on the Moog “SureFly” proof-of-concept vehicle (Huff et al., 2021).....	232
Figure 3.86 Acoustic array configuration and flightpaths used for NASA and Joby Aviation’s acoustic testing (Pascioni et al., 2022). .....	233
Figure 3.87 Battery weight to MTOW Ratio vs. UAM aircraft range for database aircraft. ....	247
Figure 3.88 Composite, fixed-pitch propeller prices based on diameter and number of blades. ....	248
Figure 3.89 Diagram of correlation between disc loading and hover lift efficiency for various VTOL aircrafts such as helicopters, tiltrotors, tilt wings, lift-fan (F-35B), and lift-jets (Harrier). Reproduced from (Maisel et al., 2000).....	249
Figure 3.90 Estimated certification cost for the first unit based on the modified Eastlake model. ....	251
Figure 3.91 Breakdown of the number of person-hours estimated by the modified Eastlake model. ....	252
Figure 3.92 AMCM estimate of DDE&T costs for the Pilatus PC-12.....	257
Figure 3.93 AMCM estimate of DDE&T costs for the HondaJet HA-420. ....	258
Figure 3.94 Impact of the number of prototypes on the AMCM estimate of DDE&T costs for the HondaJet HA-420. ....	258
Figure 3.95 Sensitivity analysis of AMCM. ....	260
Figure 3.96 AMCM project cost estimates for UAM Database Top 10+ vehicles. ....	263
Figure 3.97 Comparison of AMCM and Eastlake model project cost estimates for UAM Database Top 10+ vehicles.....	264
Figure 4.1. Daytona Beach Airspace on a VFR Sectional Chart. ....	294
Figure 4.2. KDAB diagram with a proposed vertiport location. ....	295
Figure 4.3. Preliminary Daytona Beach Boardwalk Vertiport Site. ....	296
Figure 4.4. Impactful Obstructions in the vicinity of Daytona Beach. ....	297
Figure 4.5. 3D View on Ground Obstructions around the Boardwalk Vertiport. ....	298
Figure 4.6. A proposed concept of corridor network with all transitions included. ....	299
Figure 4.7. A proposed concept of the TOMOKA Transition. ....	300
Figure 4.8. A proposed concept of the FOLIG Transition. ....	301
Figure 4.9. A proposed concept of the RIDDLE Transition. ....	301
Figure 4.10. A proposed concept of the ORMOND Transition.....	302
Figure 4.11. Amended RNAV (GPS) RY16 Approach Plate into KDAB.....	303

Figure 4.12. A proposed concept of the notional route from KDAB Vertihub to KMCO Vertihub. .....	304
Figure 4.13. GC Assessment Scores.....	314
Figure 4.14. LC Assessment Scores. ....	316
Figure 4.15. NASA TLX Adjusted Score for Each Participant in GC.....	322
Figure 4.16. NASA TLX Adjusted Score for Each Participant in LC. ....	322
Figure 4.17. Sample histogram demonstrating lack of normality. ....	323
Figure 4.18. Sample Q-Q Plot demonstrating lack of normality (i.e., skew). ....	324
Figure 4.19. UAM mission profile. ....	330

## TABLE OF TABLES

Table 2.1. VTOL Purchase Prices Found in the Public Domain (NIAR, ongoing). .....	33
Table 2.2. Operating Cost per Passenger Mile (Goyal et al. (2021)). .....	35
Table 2.3. Vertiport Estimates of European Cities for Initial Network Efficacy (EASA, 2021). .	36
Table 2.4. Estimate of Vertiport Requirements by Geography and Time Period.....	36
Table 2.5. Estimated Vertiport Sites Required for Evolving, Mature, and Fully Developed AAM Networks by MSA. ....	38
Table 2.6. Vertiport Infrastructure and Associated Costs (Black and Veatch, 2019). .....	41
Table 2.7. Revenue Forecasts - Before & During the Pandemic (UAM Geomatics, 2019-2021).46	
Table 2.8. AAM Industry Investments (SMG Consulting, 2022). .....	48
Table 2.9. Segmentation Characteristics. ....	50
Table 2.10. AAM Passenger Launch Cities (SMG Consulting, 2021). .....	65
Table 2.11. Site Suitability Analysis Variables for Advanced Passenger Mobility Markets. ....	67
Table 2.12. Data Details for Site Suitability Analysis Variables. ....	69
Table 2.13. Site Suitability Analysis Variable Weighting - Base Scenario. ....	70
Table 2.14. Most Suitable MSAs for AAM Passenger Services – Base Scenario (ASSURE A36, 2022). .....	71
Table 2.15. Most Suitable MSAs for AAM Passenger Services - Infrastructure Readiness Scenario (ASSURE A36, 2022). .....	75
Table 2.16. Bass Coefficients for All Cities. ....	79
Table 2.17. Bootstrap Confidence Intervals for Confidence Coefficients. ....	80
Table 2.18. Regression of Bass p (Innovation) Coefficients Against SSA Variables. ....	81
Table 2.19. Regression of Bass q (Imitation) Coefficients Against SSA Variables. ....	83
Table 2.20. Domestic AAM Passenger Mobility Demand: Number of Flights. ....	90
Table 2.21. Estimated AAM Passenger Mobility Ticket Prices Over Time (2022 USD). ....	91
Table 2.22. Domestic AAM Passenger Mobility Demand: Cumulative Revenue (2022 USD Billions). .....	92
Table 2.23. Operational Parameters (Goyal et al., 2021). .....	116
Table 2.24. Cost Components for AAM Passenger Market OEMs (Goyal et al. (2021)).....	117
Table 2.25. Market Development Scenario Comparisons (Goyal et al. (2021)). .....	117
Table 2.26. Estimated City Demand by Phase (UAM Geomatics, 2021). .....	119
Table 2.27. AAM Passenger Mobility Flight Demand Over Time by Major and Midsize US Market.....	120
Table 2.28. AAM Passenger Mobility Flight Demand Over Time by Major and Midsize US Market (continued). ....	121
Table 2.29. Domestic AAM Passenger Mobility Demand: Number of Flights. ....	122
Table 2.30. US Market Share and Revenue by Use Case   UAM Geomatics, 2021. ....	124
Table 2.31. Site Suitability Analysis Components. ....	125
Table 2.32. Final PCA Loadings of Rotated Solution. ....	130
Table 2.33. Suitability Variable Weighting for Additional Scenarios. ....	137
Table 2.34. Additional Suitability Scenario Results. ....	138
Table 3.1. Range and payload information of several UAM vehicles. ....	167
Table 3.2. Range and number of passengers of several UAM vehicles. ....	168
Table 3.3. Range and cruise speed of several UAM vehicles. ....	170

Table 3.4. Range and endurance of several UAM vehicles. ....	170
Table 3.5. Top 12 OEMs and their 18 VTOL vehicles studied. Data from (SMG Consulting LLC, 2022). ....	173
Table 3.6. Top vehicles and their Type Certificate approach. ....	175
Table 3.7. Top 10+ Subset Autonomous Vehicles ....	178
Table 3.8. Top 10+ Subset Vehicles – Target Operation Year Summary.....	183
Table 3.9. Pipistrel Specifications. ....	185
Table 3.10. Dynamic Test Requirements. Data Collected from 14 CFR §§ 23.562 Amdt 23-62 and 27.562 Amdt 27-32.....	200
Table 3.11. Summary of battery drop tests conditions. ....	207
Table 3.12. Crush test summary for three different standards. ....	208
Table 3.13. Shock test summary for four different standards. ....	210
Table 3.14 Summary of similarities and differences of noise characteristics for traditional rotorcraft and UAM vehicles.....	228
Table 3.15 Aircraft parameters used to develop the DAPCA IV model. ....	242
Table 3.16 Estimated airframe weight and cruise speed for UAM database vehicles. ....	243
Table 3.17 Scaling factors added to the Eastlake model to account for design considerations unique to UAM vehicles when compared with GA aircraft.....	246
Table 3.18 Scaling factors for the Eastlake model. ....	246
Table 3.19 UAM Top 10+ vehicles and performance parameter inputs for Modified Eastlake model. ....	250
Table 3.20 UAM Top 10+ vehicle architecture types used for scaling factor inputs.....	250
Table 3.21 Comparison of engineering hours estimated by the modified Eastlake model and a top-down estimation approach using publicly available data. ....	253
Table 3.22 Basic size, weight, and performance parameters for aircraft developed by the Cessna Aircraft Company in the years preceding and immediately following the development of the Cessna 172.....	254
Table 3.23 Numerical values used to code AMCM mission specification. ....	255
Table 3.24 Inputs for AMCM for two clean-sheet general aviation aircraft designs from the past 30 years. ....	256
Table 3.25 Baseline inputs for AMCM sensitivity analysis. ....	259
Table 3.26 AMCM inputs for UAM Database Top 10+ vehicles. ....	262
Table 4.1. Summary of Participant Evaluation in GC Position. ....	315
Table 4.2. Summary of Participant Evaluation in Local Control Position.....	318
Table 4.3. Analysis of TLX scores using Wilcoxon Signed-Rank Test. ....	325
Table 4.4. Analysis of ATC Performance using Wilcoxon Signed-Rank Test ....	325
Table 4.5. Standard Vertical Speeds.....	327
Table 4.6. Required Navigation Performance (RNP).....	328
Table 4.7. Approximate Separation Criteria. ....	329
Table 4.8. Vertiport Configuration (Case of KDAB-MCO).....	331



## TABLE OF ACRONYMS

AAM	Advanced Air Mobility
AC	Advisory Circular
ACAS	Airborne Collision Avoidance System
ADS-B	Automatic Dependent Surveillance - Broadcast
AFR	Autonomous Flight Rules
AGL	Above Ground Level
ALARP	As Low As Reasonably Practicable
AMCM	Advanced Missions Cost Model
Amdt.	Amendment
ANSI	American National Standard Institute
APD	Aggregate Predicted Demand
APREQ	Approval Request
ARI	AAM Reality Index
ASDE-X	Airport Surface Detection Equipment Model X
ASSURE	Alliance for System Safety of UAS through Research Excellence
ASTM	American Society for Testing and Materials
ATC	Air Traffic Control
ATCT	Air Traffic Control Tower
ATD	Anthropomorphic Test Device
ATM	Air Traffic Management
AV	Autonomous Vehicle
AWC	Airworthiness Certificate
BPF	Blade-Passing Frequency
BVI	Blade-Vortex Interaction
C2	Command and Control
CAAC	Civil Aviation Administration of China
CC	ATCT Cab Coordinator
CER	Cost Estimation Relationships
CFR	Code of Federal Regulations
CNS	Communication, Navigation, and Surveillance
CONOP	Concept of Operations
CP	Coaxial Propeller
CPI	Consumer Price Index
CRD	Comment Response Document
CTOL	Conventional Take-off and Landing
DAA	Detect and Avoid
DAPCA	Development and Procurement Costs of Aircraft
dBA	A-Weighted Decibels
DDC	Dynamic Delegated Corridors
DDT&E	Design, Development, Testing, and Evaluation
DENL	Day-Evening-Night Sound Level
DEP	Distributed Electric Propulsion
DFR	Digital Flight Rules
DNL	Day-Night Average Sound Level
EASA	European Union Aviation Safety Agency

EIS	Entry Into Service
ELOS	Equivalent Level of Safety
EMS	Emergency Medical Services
EO	Electro-Optical Sensor
EPNL	Effective Perceived Noise Level
ERAU	Embry-Riddle Aeronautical University
EUROCAE	European Organization for Civil Aviation Equipment
EUT	Equipment Under Test
eVTOL	Electric Vertical Takeoff and Landing
FAA	Federal Aviation Administration
FICON	Federal Interagency Committee on Noise
FIMS	Flight Information Management System
GA	General Aviation
GAMA	General Aviation Manufacturers Association
GC	Ground Control
GNSS	Global Navigation Satellite System
GPS	Global Positioning System
HLR	Heavy/Long Range
HMR	Heavy/Medium Range
IAP	Instrument Approach Procedures
IATA	International Air Transport Association
ICAO	International Civil Aviation Organization
IFR	Instrument Flight Rules
ILS	Instrument Landing System
IMC	Instrument Meteorological Conditions
IOC	Initial Operational Capability
IP	Integer Programming
IPP	Integration Pilot Program
IR	Infrared Sensor
IRB	Institutional Review Board
KDAB	Daytona Beach International Airport
KDED	DeLand Municipal Airport-Sidney H Taylor Field
KEVB	New Smyrna Beach Municipal Airport
KMCO	Orlando International Airport
KOMN	Ormond Beach Municipal Airport
LAAS	Local Area Augmentation System
LAHSO	Land and Hold Short
LC	ATCT Local Control
LOA	Letter of Agreement
LSA	Light Sport Aircraft
LUAW	Line Up and Wait
MOC	Means of Compliance
MOPS	Minimum Operational Performance Standards
MSA	Metropolitan Statistical Area
MSL	Mean Sea Level
MSU	Mississippi State University

MTOW	Maximum Takeoff Weight
NAS	National Airspace System
NASA	National Aeronautics and Space Administration
NCSU	North Carolina State University
NIAR	National Institute for Aviation Research
Nij	Neck Injury criterion
OASPL	Overall Sound Pressure Level
ODM	On-Demand Mobility
OEM	Original Equipment Manufacturer
OPD	Originally Predicted Demand
PAV	Personal Air Vehicle
PBN	Performance-Based Navigation
PC	Production Certificate
PCA	Principal Components Analysis
PIC	Pilot in Command
PNLTM	Tone Corrected Perceived Noise Level
PSU	Provider of Services for Urban Air Mobility
PWL	Total Radiated Acoustic Power
Q-Q	Quantile-Quantile
RAM	Regional Air Mobility
RESS	Rechargeable Energy Storage Systems
RNAV	Area Navigation
RNP	Required Navigation Performance
RPM	Revolutions Per Minute
RTCA	Radio Technical Commission for Aeronautics
RY	Runway
SAE	SAE International
SC	Special Condition
SDSP	Supplemental Data Service Provider
SEL	Sound Exposure Level
SID	Standard Instrument Departure
SMART	Simple Multi-Attribute Rating Technique
SME	Subject Matter Expert
SOC	State of Charge
SOP	Standard Operating Procedure
SPAC	Special Purpose Acquisition Company
SPL	Sound Pressure Level
SSA	Site Suitability Analysis
STAR	Standard Instrument Arrival
STOL	Short Take-off and Landing
sUAS	Small Uncrewed Aircraft System
SVO	Simplified Vehicle Operations
TC	Type Certificate
TCAS	Traffic Collision Avoidance System
TLX	Task Load Index
TNC	Transportation Network Company

TOGW	Take-off Gross Weight
TOLA	Take-Off and Landing Area
TRACON	Terminal Radar Approach Control
UAC	Uncrewed Air Cargo
UAM	Urban Air Mobility
UAS	Uncrewed Aircraft Systems
UAV	Uncrewed Aerial Vehicle
UKRI	United Kingdom Research and Innovation
UML	Urban Air Mobility Maturity Level
UNWG	UAM Noise Working Group
UOE	Urban Air Mobility Operational Environment
USS	Uncrewed Traffic Management Service Suppliers
UTM	UAS Traffic Management
VFR	Visual Flight Rules
VIF	Variance Inflation Factor
VMC	Visual Meteorological Conditions
VTOL	Vertical Take-off and Landing
WAAS	Wide Area Augmentation System
WP	Working Package
WP3	Work Package 3
WSU	Wichita State University
7FL6	Spruce Creek Airport

## EXECUTIVE SUMMARY

The Alliance for System Safety of UAS through Research Excellence (ASSURE) A36 research task “A11L.UAS.76: Urban Air Mobility: Safety Standards, Aircraft Certification and Impact on Market Feasibility and Growth Potentials” aimed to understand the emergence of Urban Air Mobility (UAM) environment by assessing and understating the markets, viability, economics, and their challenges. The research presented in this document highlights the challenges and needs of the Federal Aviation Administration (FAA) to support safe integration and could be used as a tool to assist decision-makers in the allocation of personnel and resources.

The A36 team consisted of the National Institute for Aviation Research (NIAR) at Wichita State University (WSU), Mississippi State University (MSU), North Carolina State University (NCSU), and Embry-Riddle Aeronautical University (ERAU). The research task covered three major areas of research presented in this document as three Working Packages (WP).

MSU and NCSU completed the WP #1 task titled “Evaluation of UAM Market Potential: Economic Feasibility, Potential Size and Growth, Characteristics of Population, and Ground Infrastructure.” The WP #1 team forecasted the demand for domestic UAM passenger markets, including the airport shuttle, air taxi, regional passenger transport, emergency medical service, and corporate shuttle use cases. Using a Site Suitability Analysis framework, the top 100 Metropolitan Statistical Areas (MSAs) were ranked and scored. The results of the site suitability analysis were used in conjunction with a bass diffusion market penetration model to estimate how demand within these MSAs evolves from the present through 2045. An extensive literature review of over 100 journal articles, reports, industry papers, and market resources informed passenger mobility market milestones and transition points.

The WP #1 research findings demonstrated that in 2045, approximately 85.4 million advanced passenger mobility trips will be made<sup>1</sup>. Therefore, looking at demand cumulatively, a total of 525.3 million trips are estimated to be made from 2022-2045. This equates to \$72.5 billion in cumulative revenue over that time period.

The WP #2 task titled “Airworthiness regulations and their applicability to UAM aircraft certification” aimed to investigate current regulatory frameworks' applicability to UAM vehicles. In addition, this WP also aimed to investigate the classification of UAM vehicles in terms of airworthiness and methods to estimate program development and certification costs for these vehicles. The WP #2 team consisted of personnel from NIAR.

The WP #2 team first studied the Vertical Take-off and Landing (VTOL) market through a comprehensive database from the [evtol.news/aircraft](http://evtol.news/aircraft) website (updated in June 2021). The definition of a UAM vehicle as defined by the National Aeronautics and Space Administration (NASA) UAM Noise Working Group helped refine the database to 212 relevant vehicles by filtering out large numbers of non-UAM vehicles. This study tracked a variety of parameters such as vehicle architecture, maturity level, vehicle mission purpose, propulsion system, etc. Because most 212 UAM vehicles are still in the design phase, a more focused study examined the top 10+ vehicles with the highest possibility of entering the operation phase based on the Advanced Air

---

<sup>1</sup> For the purposes of this study, advanced passenger mobility trips are defined as trips made by Vertical Takeoff and Landing (VTOL) aircraft that can hover, take off and land vertically without relying on a runway as well as Regional Air Mobility (RAM) aircraft that travel distances from 50-500 miles and employ semi- or fully-autonomous technology.

Mobility (AAM) Reality Index (ARI). The ARI scores in this subsequent study were last updated in February 2022. This top vehicle study gives a clearer picture of the UAM market. In particular, the analysis showed that vectored thrust vehicles are most likely to be operational before 2030 due to the highest interest from the Original Equipment Manufacturers (OEMs).

The WP #2 team next investigated the applicability of the regulatory standards to UAM vehicles, focusing on Electric Vertical Takeoff and Landing (eVTOL) and battery crashworthiness and noise. The requirements in the regulatory framework of both the European Union Aviation Safety Agency (EASA) and FAA are based on existing standards (the majority are based on Part 23 (CS-23) and Part 27 (CS-27)). While the EASA has created a Special Condition (SC) document for requirements and is currently working on the development of specific Means of Compliance (MOCs), the FAA implements the path described in 14 Code of Federal Regulations (CFR) §21.17(b).

Traditionally, crashworthiness requirements have been derived from statistical distribution studies based on historical data from accidents. These existing requirements might not apply to UAM vehicles as written due to the vehicles' novel architectures, technologies, or mission types. Specifically, the definition of dynamic conditions will most likely need to change for UAM vehicles. The WP #2 team recommends that the FAA has a concrete definition of emergency landing conditions per UAM operations. The WP #2 team identified that the battery drop test requirement of the EASA SC-VTOL was the only specific requirement that provided details on the loads expected during an emergency landing. The team investigated automotive standards for batteries that focused on conditions applicable to emergency landing conditions such as crush and mechanical shock. The team recommends including mechanical abuse tests for batteries in the regulatory framework. Adding a requirement for the battery manufacturers to comply with an existing standard would suffice.

The WP #2 team identified several limitations in the current set of noise regulations, i.e., 14 CFR Part 36, in their applicability to UAM vehicles. These limitations will need to be addressed by the FAA to establish a generic set of certification requirements and procedures that apply to a wide class of UAM vehicles. For example, limited acoustic flight testing data suggests that UAM vehicles that rely on Distributed Electric Propulsion (DEP) may be significantly quieter compared to traditional rotorcraft. Nevertheless, appropriate certification procedures and MOCs still need to be developed for these vehicles to show compliance with Part 36 requirements. Some high-level recommendations to amend Part 36 include 1) the addition of appendices to accommodate the different UAM architectures; 2) expanding the definition of "worst-case" conditions for UAM vehicles; 3) lowering the flightpath altitude for the certification flight tests in order to distinguish the noise profile of the vehicle from the background ambient noise; and 4) including hover and transition conditions in the certification requirements. In-depth recommendations for modification of Part 36 requirements and derivation of appropriate MOCs will require more acoustic testing of UAM vehicles (both ground and flight) and dissemination of the acoustic test data to the community.

Lastly, the WP #2 team investigated three existing tools designed for the aerospace industry to evaluate UAM vehicle program development and certification costs and evaluated the estimates from two of the tools. None of the models separated the costs of certifying an aircraft from the cost of developing it. However, long-range projections from the NASA Advanced Missions Cost Model estimated that costs to bring a UAM vehicle to market would be between \$500 million and \$2

billion. More detailed and accurate estimates require significant data from the development cycle of UAM vehicles that are successfully brought to market. Record keeping of this data should be encouraged by regulators to help build an understanding of this new aviation segment.

The WP #3 task titled “Evaluation of UAM integration on the National Airspace System – Air Traffic Control and Operations” aimed to identify the impact of UAM on the National Airspace System (NAS) with respect to Air Traffic Control (ATC), infrastructure, and operations via the introduction of common terms and definitions, research gaps that exist for a successful integration, as well as certain assumptions and limitations that are imposed on this research study. The WP #3 team consisted of personnel from ERAU.

The WP #3 team developed a Daytona Beach International Airport (KDAB) airspace UAM integration concept to model the airspace environment, including UAM corridors, vertiport locations, vertiport ingress/egress, operational limits (altitudes, velocities, etc.), and Communication, Navigation, and Surveillance (CNS) requirements. The key thought behind this UAM concept was to combine already existing airspace elements with the novel concepts of UAM operations and environment. Simulation scenarios used for the purpose of this study attempted to closely replicate the team’s vision on the airspace environment formed based on the literature review, FAA guidance, and subject matter expertise.

The simulation environment leverages ERAU’s Air Traffic Control Tower (ATCT) simulators. KDAB served as the host environment for both ATCT and airspace environments for which simulation scenarios with and without UAM are evaluated. The simulation environment simulates a vertihub at KDAB and a vertiport at the parking garage near the downtown Daytona Beach Boardwalk. Waypoints served as fixes between airspace corridors that establish route(s) between KDAB, downtown Daytona, and ingress/egress points for UAM traffic coming to/from nearby airports, including Orlando International Airport (KMCO). The simulator allowed both simulated manned and unmanned traffic to operate in the simulation environment, with pseudo-pilots controlling the aircraft and providing communications with the ATC participants. Participants are assigned to serve in the Local Control (LC) or Ground Control (GC) positions within the ATCT.

The WP #3 team selected two metrics to assess the impact of UAM on the NAS. First, participants completed the NASA Task Load Index (TLX) workload assessment survey after each scenario to measure the impact on controller workload. Second, the team used an ATC performance assessment sheet tailored from the grade sheets used in ERAU’s ATC laboratory. This report summarizes observations about the data, participant performance, etc. The Wilcoxon Signed-Rank Test is used to determine the statistical significance of score differences between the non-UAM vs. UAM environment and their positions, GC, and LC.

In this report, the WP #3 team provides a detailed discussion regarding the ATC performance scores for both LC and GC positions. In general, experimental results and analysis show a statistically significant difference in ATC performance for both GC and LC positions when comparing operations with and without UAM present. Participants scored lower performance scores with UAM present. For GC, mistakes made included failure to protect taxiing aircraft from overflying UAM emergency, failure to issue runway crossing or notify LC once a crossing was complete, over protection or under protection of the vertihub, issuing traffic for aircraft regarding UAM aircraft when not necessary, etc. The TLX survey did not show with statistical significance any difference

between non-UAM vs. with UAM for both GC and LC. However, the team observed a statistically significant difference between LC and GC. LC had a higher mean workload than GC.

According to the WP #3 team, operational and procedural requirements must leverage previous work to enable UAS Traffic Management (UTM) integration into the NAS UAM system. With increased air traffic, Providers of Service for UAM (PSUs) must coordinate traffic within the PSU network and plan flight operations while considering urban airspace congestion, the location of nearby airspaces, weather restrictions, ATC coordination, and enabling greater use of automation. The data must also be shared with UAM operators, PSUs, Unmanned Traffic Management Service Suppliers (USSs), the FAA, and other stakeholders. As UAM traffic density increases, ATC's roles and responsibilities in addressing UAM systems must be reduced because it would impede ATC performance by increasing workload. As a result, as with UTM, PSUs are delegated airspace management responsibilities for UAM, with ATC and UAM coordinating for situational awareness and handling off-nominal conditions.

From a CNS perspective, the requirements focus on providing new systems to meet the needs of the future UAM paradigm. They are used as a starting point for developing cooperative and non-cooperative monitoring systems. To safely integrate UAM into shared or adjacent airspace with non-UAM air traffic, the requirements of the UAM system must be considered so that the aircraft remains within the available air volume designated according to a given flight plan/schedule. Therefore, the requirements of each CNS focus area should lead the way to an integrated architecture that can meet the expected demand for integrating UAS into NAS.

A substantial amount of infrastructure must be built and installed to enable UAM operations, in addition to the required aircraft, procedures, and airspace planning. UAM, UTM, and NAS general infrastructure, as well as vertiports and corridor needs, are among these infrastructure types. In addition, the impact of infrastructure and infrastructure design on public acceptance, which determines UAM traffic density, should also be considered. To guarantee a safe UAM integration into the NAS, the coordination of segregated and non-segregated airspace elements between UAM and non-UAM air traffic needs to be addressed. Studies pointed out that combining UAM aircraft with conventional aircraft in the same airspace is more effective than separating them. A long-term solution is anticipated to combine all operations into a single conjoint system.

The safe integration of new entrants into the NAS represents a significant challenge. UAM is a new opportunity for aviation that could revolutionize the transportation system. It is a challenging use case for transporting cargo and passengers in an urban environment. This should include the creation of standards or even a set of firm recommendations for standards. The FAA is dedicated to developing the technical and regulatory standards, policy guidance, and operational procedures on which successful UAM integration depends. However, for future standardization, several methods and recommendations that are widely employed in the aeronautics sector should be heavily taken into consideration. It may take less time to build technological and regulatory standards if academics and industry apply their financial and human resources to support crucial FAA efforts. Together, all parties can successfully integrate UAM into the NAS and use UAM and related technologies for a societal advantage.



# 1 INTRODUCTION

The vision to revolutionize mobility within metropolitan areas is a new frontier in aviation. Supporting accessible air transport systems for passengers and cargo by working with the Urban Air Mobility (UAM) community to identify and address the opportunities and key challenges ahead is an emerging role for the Federal Aviation Administration (FAA). The UAM ecosystem and its associated technologies are likely among the most complex aviation ever encountered. As the price of traveling by air in cities becomes more affordable, demand is only expected to increase, with an expected compound annual growth rate of 17.28% until 2035 (Mordor Intelligence, 2021).

To understand how the UAM environment could emerge and respond proactively, it is necessary to be informed by assessing and understating the markets, viability, economics, and challenges that will arise. The research presented in this document highlights the challenges and needs of the FAA to support safe integration and could be used to assist decision-makers in allocating personnel and resources.

In the FAA Modernization and Reform Act of 2012, Congress tasked the FAA with integrating Unmanned Aircraft Systems (UASs) into the National Airspace System (NAS). To comply with the Congressional mandate, the FAA established an sUAS rule (published within the Code of Federal Regulations as 14 CFR Part 107), allowing sUAS to operate in the NAS. In its core proposition and approach, the proposed research is "basic and early-stage applied research" in understanding UAM operations in the NAS. Designed as a short-term research project, the primary results will likely yield effective and "quantitative metrics" in evaluating (Mulvaney & Kratsios, 2017) as a further step toward UAS integration into National Airspace System, or NAS. Understanding the volume and magnitude of UAM is essential in understanding safety implications and in prioritizing the Agency resources together with the timing of allocating these scarce resources. Accordingly, the research presented in this document is designed to capture the following characteristics of the market potential together with the implications on resources:

- Potential size and growth of the market at the local and/or national level;
- Economic feasibility, including price points at which individual market becomes viable;
- The anticipated cost to enter the market, considering factors such as vehicle acquisition and life cycle, operation liability, maintenance and replacement, and upgrade schedules;
- Customer segments (e.g., regular business commuters, ad hoc travelers, etc.) for UAM viability;
- Characteristics of population density, traffic patterns including congestion, affordability, and preferred locations;
- Competition for UAM transportation or services (e.g., driverless cars and multi-modal transportation options, on-demand ride-hailing services, virtual presence, etc.), providing cost comparisons where applicable; and
- Ground infrastructure requirements, legal and management strategies consistent with the envisioned UAM network, and connectivity to other transportation modalities as needed for efficient, "door-to-door" travel and unplanned landing sites.

Furthermore, as part of the Part 107 rulemaking effort, the FAA selected the American Society for Testing and Materials (ASTM) to establish a set of standards for airworthiness, maintenance, and operation in support of Part 107. Understanding safety requirements for UAM, drawing upon the

lessons learned from Part 107, will require understanding barriers for additional demands on the NAS. While some of the existing constraints have been documented (Thippavong et al., 2018), detailed analyses are presently unavailable, and implications for UAM emergence and its penetration are unclear. This research addresses some of the fundamental questions about how UAM:

- May impose a demand on additional ATC infrastructure, including airspace and workload on controllers?
- May require a new paradigm to integrate with UTM and/or Air Traffic Management (ATM)?
- May impose a demand on regulatory requirements, including standards for airworthiness, certifications for design, maintenance, and operations for vehicle-level and system-level safety and security?
- Will economically scale to high-demand operations with minimal fixed costs? and
- Will support user flexibility and decision-making, including demands emanating from emerging UTM?

To answer these questions, the research is organized into three working packages. Each of these working packages' findings and conclusions are presented throughout Sections 2 and 4:

- WP 1 (Section 2): Evaluation of UAM Market Potential: economic feasibility, potential size and growth, characteristics of population, and ground infrastructure.
- WP 2 (Section 3): Airworthiness regulations and their applicability to UAM aircraft certification.
- WP 3 (Section 4): Evaluation of UAM integration on the National Aerospace System – Air Traffic Control and Operations.

## **2 EVALUATION OF UAM MARKET POTENTIAL: ECONOMIC FEASIBILITY, POTENTIAL SIZE AND GROWTH, CHARACTERISTICS OF POPULATION, AND GROUND INFRASTRUCTURE**

### **2.1 Research Context**

The vision to revolutionize mobility within metropolitan areas and beyond is one of the new frontiers in modern aviation. Building on the successes of the Beyond Program initiated during the Integration Pilot Program (IPP), aviators are paving the way for Uncrewed Air Cargo (UAC), followed eventually by uncrewed passenger transport. A continuous role for the Federal Aviation Administration (FAA) will be the engagement with the aviation community to identify and address the key differences between uncrewed and crewed operations, opportunities, and challenges underlying this development. The passenger transportation network ecosystem and its associated technologies are likely to be among the most complex aviation endeavors the aviation community has experienced, and the opportunities to facilitate the full integration of Uncrewed Aircraft Systems (UAS) into the National Airspace System (NAS) are monumental. As the FAA requires further understanding of this environment to analyze the differences as they compare to traditional crewed air transportation and air cargo, these analyses will enhance decision-making for future policy development. This research will highlight the anticipated needs of the FAA to support further integration of UAS in air transportation and air cargo operations in metropolitan areas across the US, including suburbs and exurbs.

The A36 research team conducted a literature review, market analysis, Site Suitability Analysis (SSA), and bass diffusion modeling to explore advanced passenger mobility. For the purposes of this study, advanced passenger mobility consists of the movement of passengers with vertical takeoff and landing (VTOL) or Regional Air Mobility (RAM) aircraft and includes the airport shuttle, air taxi, regional air travel (50-500 miles), emergency medical service, and corporate shuttle use cases.

Through the literature review, important aspects of Advanced Air Mobility (AAM) such as economic drivers, technology advancement, and the overall societal acceptance of this new aviation paradigm are explored. Building from the literature review, the market analysis discusses passenger mobility market segments, favorable market conditions, costs to enter these markets, competition for advanced passenger mobility services, enabling infrastructure, and the effect of the global COVID-19 pandemic on market conditions. Ultimately, the analysis presents forecasts of advanced passenger mobility market demand from the present day through 2045 by collating market research, economic growth trajectories, and developing defensible market projections for advanced passenger mobility market segments.

### **2.2 Market Analysis**

#### ***2.2.1 Market Characteristics and Viability***

Advanced passenger mobility will undergo several stages of transition within the next few decades bringing opportunities for travel that will shape our everyday lives. According to a Deloitte Insights market study (Hussain and Silver, 2021), the adoption of advanced mobility services is expected to occur over six phases, as shown in Figure 2.1. These phases will correspond with the transition

from piloted to fully-autonomous vehicles and the spread of UAM flight services from a few concentrated cities to multiple locations throughout the US.

**Phase 1 – Certification, Testing and Evaluation**

First, the industry will undergo a certification, testing, and evaluation phase. Passenger services are firmly progressing within this stage with over a dozen Original Equipment Manufacturers (OEMs) vying for Entry Into Service (EIS) dates as early as 2025, as shown in Figure 2.2. During this phase, numerous organizations will have gone beyond the research and development stage to undergo testing and piloting. Aircraft prototypes will be deployed as the industry prepares for the launch of UAM passenger services.

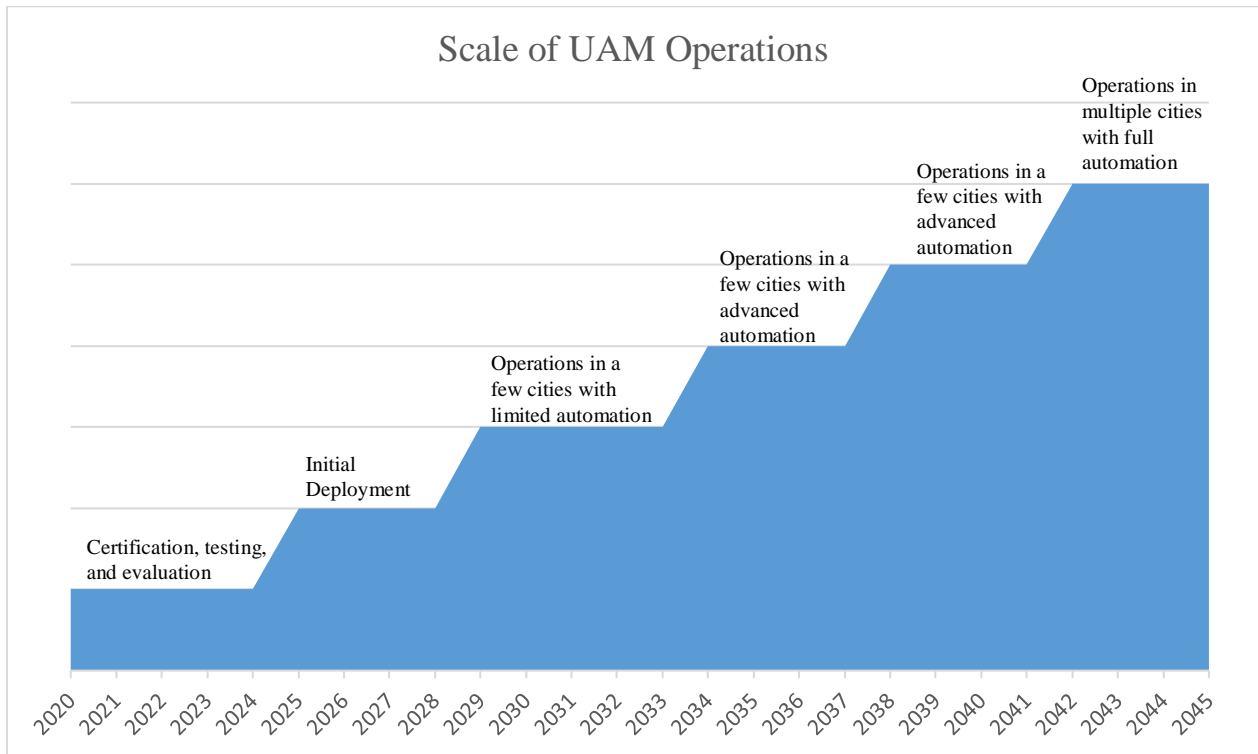

Figure 2.1. Advanced Passenger Mobility Growth Paradigm (Hussain and Silver, 2021).

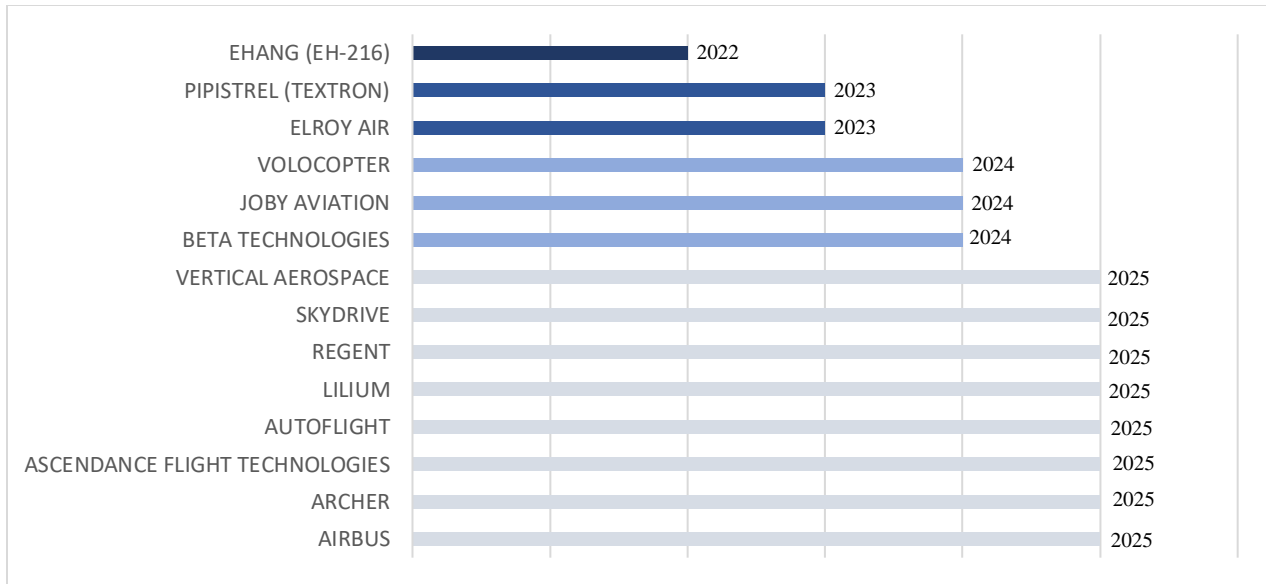

Figure 2.2. OEMs and Their Associated Entry Into Service Dates (SMG Consulting, 2022).

### ***Phase 2 – Initial Deployment***

The UAM industry will witness the launch of less-complex commercial operations in a few cities around the world within the next few years. In the US, those cities are anticipated to be New York with the emergence of Blade flight services, Los Angeles with the initiation of Archer, Orlando with Lillium taking flight from the Lake Nona Aerotropolis, and Miami with Archer services planned for takeoff (SMG Consulting, 2021). Joby also plans to launch within the next few years in California, among other global and domestic markets (Joby, 2022). During this phase, it is anticipated that continuous regulatory engagement will be essential to ensure both a swift and safe transition from piloted to unpiloted services in the years to follow.

### ***Phase 3 – Operations in a Few Cities with Limited Automation***

New infrastructure investments and lessons learned from phases one and two will create a pathway for less complex commercial operations to occur in a few cities by 2028 (Hussain and Silver, 2021). It is anticipated that the launch cities discussed in Phase 2 will begin to see AAM services that offer limited automation. Additionally, other locations in the US will prepare for advanced passenger mobility services. In later phases of AAM development, limited automation will transition to more advanced and then fully-autonomous applications.

### ***Phase 4 – Operations in a Few Cities with Advanced Automation***

During Phase 4, passenger operations with moderate complexity will emerge. It is anticipated that new passenger service launch sites will come online, while other sites will enter into their final stages of market readiness. Probable locations for additional UAM passenger service launch sites include the locations being evaluated as part of the National Aeronautics and Space Administration’s (NASA’s) set of *Community Annex Teams*, such as Minneapolis, Dallas, Columbus, and Boston (NASA, 2021a).

### ***Phase 5 – Operations in Multiple Cities with Advanced Automation***

As 2040 approaches, commercial deployment with advanced automation is expected in multiple urban, suburban, and rural areas (Hussain and Silver, 2021). By this phase, the industry will have found solutions to some fundamental issues (e.g., collision avoidance systems, on-board sensors, and cognitive systems). Complexity with automated flight processes will have gradually increased, enabling advanced passenger mobility applications to move into rural, suburban, and urban environments with large populations, obstructions, and traffic density.

### ***Phase 6 – Operations in Multiple Cities with Full Automation***

In the final phase of market development, it is anticipated that the commercial deployment of UAM passenger services will be widespread and will have achieved full automation. It is anticipated that passenger service providers will expand into new locations with favorable market conditions. These conditions include high levels of economic activity, the prevalence of vertiports or enabling infrastructure, surface transportation that is highly congested and could be alleviated by UAM alternatives, as well as other site-selection criteria. An in-depth discussion of the favorable market conditions that would attract AAM passenger services can be found on page 65, see “Target Markets and Suitable Market Conditions.”

#### ***2.2.2 Market Overview and Submarkets***

Advanced air mobility will revolutionize the way people travel to work, hospitals, and other key destinations. Passenger services could have far-reaching economic consequences, including altering housing and business locations due to newly available and fast transportation (Rothfeld et al., 2020). The emergence of new advanced passenger mobility technologies will also bring about a variety of new services in five distinct market segments, including airport shuttles, regional air mobility, on demand air taxis, corporate campus shuttles, and emergency services.

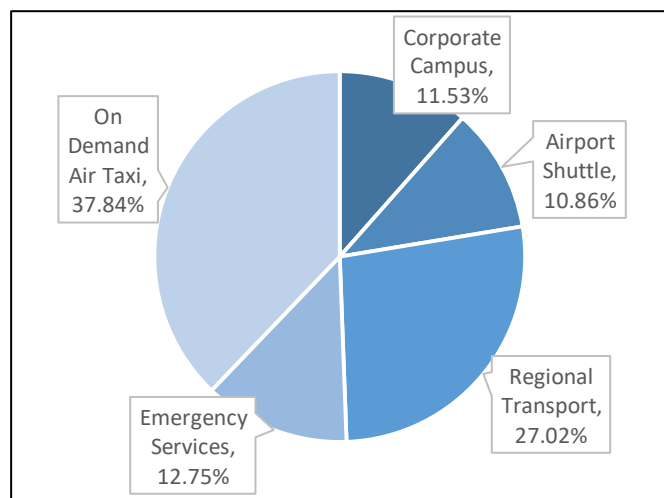

Figure 2.3. Market Segments (UAM Geomatics, 2022).

As the VTOL advanced passenger mobility markets mature, it is anticipated that on demand air taxi and RAM services will have the highest total passenger revenues (UAM Geomatics, 2022). These two market segments will net approximately two-thirds of advanced passenger mobility market revenue while airport shuttles, corporate campus shuttles, and emergency services will generate the remaining third, as seen in Figure 2.3.

## 2.2.2.1 Urban Air Mobility (UAM) Applications

### 2.2.2.1.1 Airport Shuttle

It is anticipated that airport shuttles, which will transport people to and from airports, will become the entry point for UAM passenger market activities (Goyal et al., 2021). Airports generate a relatively predictable demand for transportation services to and from their terminals, and they often contain essential ground infrastructure components that enable UAM passenger services. Blade currently offers traditional helicopter charter services that connect people from John F. Kennedy International Airport (JFK) and Newark Airport (EWR) to select locations in Manhattan for \$195 (Blade, 2022). It is anticipated that Blade will transition into a UAM paradigm for its services as soon as 2024 (SMG Consulting, 2021).

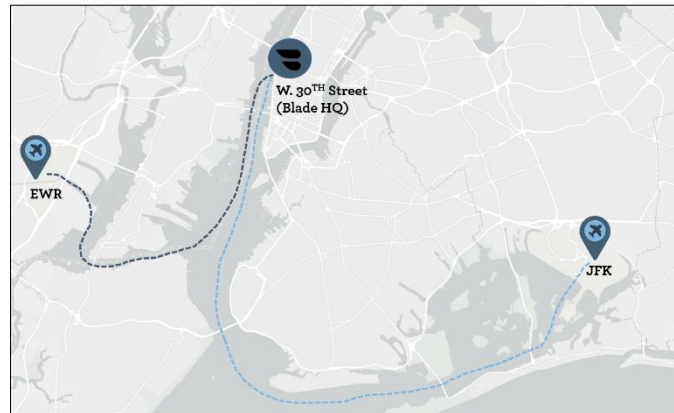

Figure 2.4. Airport Shuttle Concept (Blade, 2022).

Airport shuttles are anticipated to be an invaluable transportation option for domestic and global business travelers who fly into commercial airports and very quickly need to reach nearby destinations for business appointments. Similarly, airport shuttles are expected to provide transportation services to leisure travelers seeking fast and reliable transportation. As the UAM passenger market matures, it is expected that the airport shuttle market segment will generate approximately 11 percent of the industry's revenue (UAM Geomatics, 2022).

### 2.2.2.1.2 Air Taxi

In a fully mature paradigm, air taxis are envisioned to offer thousands of people autonomous or semiautonomous air mobility services on a daily basis in major cities (Hill et al., 2020). Air taxis will likely involve a combination of ground transportation ridesharing and air transport. According to Crown Consulting Inc. et al. (2018), air taxis will evolve to provide door-to-door ridesharing services that allow consumers to call Vertical Takeoff and Landings (VTOLs) to their desired pickup locations and specify drop-off destinations at rooftops throughout a given city.

During its June 3, 2021, Analyst Day presentation, Joby Aviation demonstrated examples of what an initial air taxi concept would look like in California, as shown in Figure 2.5. A trip from Santa Monica Airport (SMO) to Burbank Airport (BUR) would take an estimated 10 minutes, compared to 39 minutes of drive time. As new ground infrastructure (vertiports, vertipads, and future adaptations of helipads with fueling and charging) is constructed, additional flight paths would become available, creating air transportation services that dramatically improve travel times. Eventually, a network of small, electric aircraft that take off and land vertically would enable rapid, reliable transportation between suburbs, cities, and within cities (UAM Geomatics, 2021).

Air taxi services are expected to provide enhanced transportation services to a wide range of customers including daily commuters, holiday travelers, and tourists, among other individuals. As the UAM passenger market matures, it is expected that the air taxi market segment will generate approximately 38 percent of the industry’s revenue, making it the largest passenger market segment (UAM Geomatics, 2022).

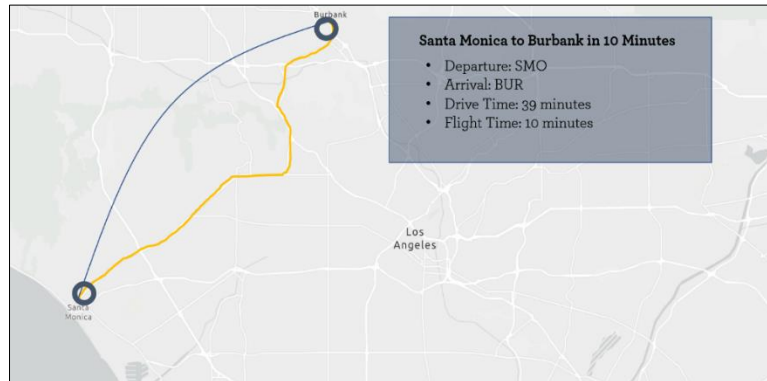

Figure 2.5. Initial Air Taxi Concept (Joby, 2021).

### 2.2.2.1.3 Corporate Campus Shuttle

Business aviation is a global US\$100 billion per year industry, and business aircraft enable businesses to transport their vital company assets, including key executives, employees, and products (UAM Geomatics, 2021). Corporate shuttle services will likely compliment a corporation’s aviation fleet and help solve their “last mile” challenges by connecting corporate staff to business meetings or other locations in the city center. These corporate shuttles are expected to be electric or hybrid aircraft capable of VTOL.

As the UAM passenger market matures, it is expected that the corporate campus shuttle market segment will generate approximately 12 percent of the industry’s revenue (UAM Geomatics, 2022).

### 2.2.2.2 Regional Air Mobility

RAM is a relatively new concept for air transportation that seeks to capitalize on the vast network of airports that dot the landscape of the US. RAM is an air mobility paradigm that offers the potential for smaller airports to serve as transportation nodes, offering more frequent flights of moderate distances in lighter, cost-effective aircraft. RAM is anticipated to take advantage of aircraft that are uniquely outfitted for operations within smaller communities, filling in a niche that goes beyond more conventional commuter aircraft. RAM aircraft are anticipated to carry passengers between 50 and 500 miles, generate less noise, handle steep climb/descent profiles, and operate from short runways (eventually vertiports) within smaller communities (NASA, 2021b; UAM Geomatics 2021).

RAM is likely to revolutionize travel in megaregions, which have large urban centers that attract people for business or leisure. Lilium has developed initial concepts of RAM that it is exploring for future operations in California and the Northeast with flight ranges up to 186 miles, as shown in Figure 2.6. As the AAM passenger market matures, it is expected that the RAM market segment will generate approximately 27 percent of the industry’s revenue, making it the second largest AAM passenger market segment (UAM Geomatics, 2022).<sup>2</sup>

<sup>2</sup> For the purposes of this study, the RAM market segment includes aircraft that travel distances from 50-500 miles and employ semi- or fully-autonomous technology. This definition was used to forecast demand for the RAM use case.



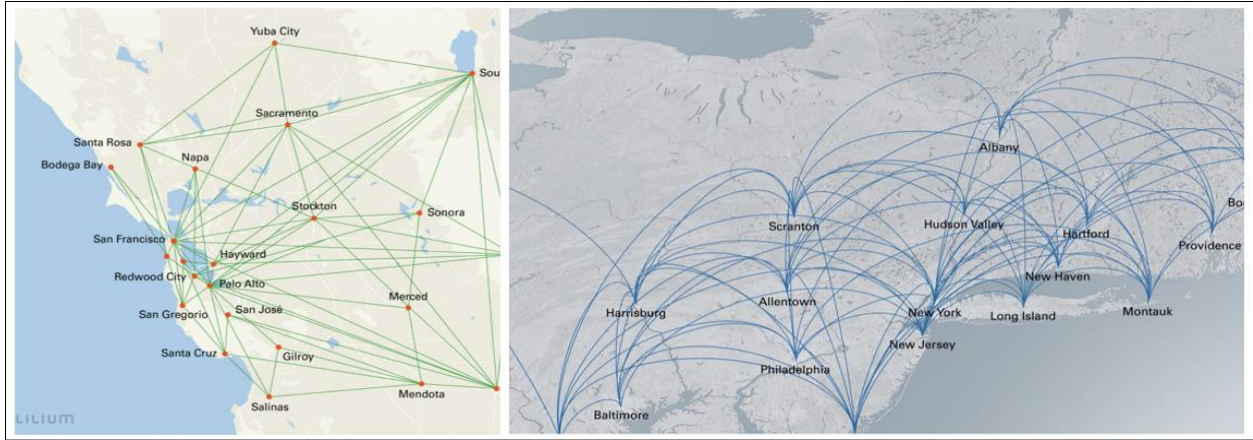

Figure 2.6. Initial Regional Air Mobility Concepts (Lilium, 2022).

### 2.2.2.3 Emergency Services

Traditional Medevac flights are expensive with average costs of approximately \$25,000 per flight (UAM Geomatics, 2021). By comparison, a UAM alternative could reduce healthcare system costs by millions of dollars annually (UAM Geomatics, 2021). As the UAM passenger market matures, it is anticipated that the emergency services market segment will generate approximately 13 percent of the industry’s revenue (UAM Geomatics, 2022).

### 2.2.2.4 Summary

In the near future, it is expected that major metro areas will witness the rise in airport shuttle services and that the domestic market will transition into regional air mobility, emergency, and corporate campus shuttle services shortly thereafter. As ground infrastructure becomes more widespread, it will enhance the viability of air taxis, which will likely emerge thereafter.

This section has given an overview of the various UAM and RAM submarkets that have projected growth over the next few decades. For an analysis of market segments, see “Market Segmentation Analysis” on page 49.

### 2.2.3 Costs to Enter the Market

A variety of technological advancements and industry investments in electrification, automation, VTOL aircraft, UAS, and air traffic management are enabling innovations in aviation, such as new aircraft designs, services, and business models (Goyal et al., 2021). These advancements are allowing the creation of an entirely new UAM passenger marketplace. As with any technological advancement, the cost of service will directly impact utilization, or user demand.

The impact of price on UAM VTOL demand can be evidenced in study findings from Rimjha et al. (2021). The research demonstrates that a user cost of \$1 per mile would generate approximately 42,140 daily round-trips in Northern California; however, a cost increase of just 20 cents per-mile would reduce demand in the region by 34 percent. Thus, having a thorough understanding of UAM passenger vehicle lifecycle costs (vehicle acquisition, operations, maintenance, replacement, and upgrades) and other advanced passenger mobility cost structures is an invaluable component of demand modeling.

### 2.2.3.1 Lifecycle Costs

#### Vehicle Acquisition

Joby Aviation projects that its aircraft will cost it \$1.3 million apiece to build and that revenue-earning aircraft purchased in 2026 will recoup capital costs by 2028 (Bogaisky, 2021). This payback estimate is based on the assumption that Joby will operate its aircraft an average of 40 flights a day, seven days a week, with an average of 2.3 passengers per flight, over an average distance of 26 miles (Bogaisky, 2021; Head, 2021a). Though Joby projections may be highly ambitious, they offer a datapoint to better ascertain AAM passenger market lifecycle costs.

Esqué and Riedel (2022) offer another guidepost for vehicle acquisition costs. They reviewed AAM industry orders received for approximately 6,850 aircraft worth a total estimated value of \$26.1 billion. This equates to an average aircraft purchase price of approximately \$3.8 million for crewed and uncrewed AAM aircraft.

As part of an ongoing ASSURE research project led by the National Institute for Aviation Research (NIAR) at Wichita State University, a database was developed that contains VTOL aircraft specifications. This database is utilized in the market analysis and demand estimation sections of this document and is subsequently referred to as the NIAR VTOL database. The database contains vehicle purchase prices for 21 VTOLs that will serve the AAM passenger market. Findings have been extracted and included in Table 2.1. It is anticipated that the aforementioned ASSURE research project will be completed in the Fall of 2022.

Table 2.1. VTOL Purchase Prices Found in the Public Domain (NIAR, ongoing).

OEM	Mission Purpose	Vehicle Cost (\$millions)
Archer	Air Taxi	\$5,000,000
Joby	Air Taxi	\$1,300,000
Ehang	Air Taxi	\$336,000
Samad Aerospace	Regional	\$10,000,000
XTI	Regional	\$6,500,000
ASX	Air Taxi	\$1,000,000
Astro Aerospace	Personal Air Vehicle	\$150,000
LIFT Aircraft	Personal Air Vehicle	\$500,000
Flutr Motors	Air Taxi	\$200,000
Daymak Avvenir	Personal Air Vehicle	\$250,000
Doroni	Personal Air Vehicle	\$150,000
Lilium	Regional	\$4,500,000
Moog	Air Taxi	\$200,000
Vickers Aircraft Company	Personal Air Vehicle	\$180,000
EAC (Electric Aircraft Concept)	Air Taxi	\$200,000
DeLorean Aerospace	Personal Air Vehicle	\$275,000
Autonomous Flight	Air Taxi	\$27,000
Horizon Aircraft	Air Taxi	\$3,500,000
Transcend Air	Regional	\$3,500,000
Scienex	Air Taxi	\$200,000
Horizon Helicopters	Air Taxi	\$1,000,000

Source: National Institute for Aviation Research (NIAR) at Wichita State University, 2022 | ASSURE Project A36 (project ongoing)

## ***Operations, Maintenance, Replacement, and Upgrades***

Battery lifespans and their associated costs will have a notable influence on advanced passenger mobility market viability. In 2019, Uber Elevate (before being acquired by Joby Aviation) estimated that an amortized battery cost for electric Vertical Takeoff and Landing (eVTOL) air taxis of \$76 to \$90 per flight hour, which would equate to \$194,000 to \$230,000 annually (Head, 2021a). Battery costs are anticipated to decrease substantially through advancements in research and development. For example, on October 29, 2020, Joby Aviation filed a patent application for a battery thermal management system, which would offer improvements in battery life through the use of a cooling system, a reservoir, a de-ionization filter, a battery charger, and a controller (US Patent & Trademark Office, 2020).

There are several other components beyond an eVTOL's battery that should be considered when evaluating OEM lifecycle costs. As part of their efforts in a seminal market study, the *Urban Air Mobility Market Study* submitted to NASA in 2018, and as part of a follow-up article in the *Sustainability Journal*, Goyal et al. (2021) thoroughly document the various cost components that should be evaluated as OEMs consider market entry. Their work provides a detailed accounting of the various costs to enter the AAM passenger market. Their cost analysis involved an in-depth evaluation of nine different aircraft types using electric, hybrid, and JetA powertrains, shown in the blue callout box to the right. The analysis also involved a literature review and consultation with a strategic advisory group that led to an assessment of more than 70 aircraft designs and performance characteristics. Aircraft cost specifications were calculated on a per-seat basis and were extrapolated for aircraft with more than one seat.

Goyal et al. (2021) assessed AAM passenger market costs by taking the sum of direct operating costs and indirect operating costs. Direct operating costs include capital, energy, battery, crew, maintenance, insurance, infrastructure, and route costs, whereas indirect operating costs include marketing and reservation costs. By using these cost components, the authors developed a pricing model to calculate the price that would be needed to charge passengers to generate a profit margin of 10-30 percent. The authors used a cost-plus profit pricing strategy and assumed

### **Price Per Passenger Mile Cost Analysis | Goyal et al. 2021**

The authors analyzed nine types of aircraft to calculate OEM operator costs. These aircraft included:

- Coaxial rotor—a design with rotors mounted one above the other (e.g., GoFly).
- Lift + cruise—a design that has independent thrusters for cruise and lift (e.g., Aurora Flight Sciences).
- Tilt wing—an aircraft that uses a wing that is horizontal for conventional forward flight and rotates up for VTOL (e.g., A3 Vahana).
- Compound helicopter—a design with a helicopter rotor-like system and one or more conventional propellers to provide forward thrust during cruising flight (e.g., HopFlyt).
- Tilt rotor—an aircraft type that generates lift and propulsion by way of one or more powered rotors mounted on rotating engine pods or nacelles (e.g., Joby Aviation).
- Multirotor—a rotorcraft with more than two rotors (e.g., Ehang and Volocopter).
- Autogyro—a type of rotorcraft, which use an unpowered rotor in free autorotation to develop lift (e.g., Carter).
- Conventional helicopter—a type of rotorcraft in which lift and thrust are supplied by rotors (e.g., Robinson R22).
- Tilt duct—an eVTOL in which a propeller is inside a duct to increase thrust (e.g., Lilium Jet).

that OEMs would be subjected to taxes and fees, comparable to taxis and Transport Network Companies (TNCs). Instead of attempting to “reinvent the wheel,” the research of Goyal et al. (2021) is used to demonstrate the costs OEMs face to enter the market. Based on their assumptions, it is estimated that a five-seat eVTOL will cost approximately \$6.25 per passenger mile in the near term, as shown in Table 2.2.

Table 2.2. Operating Cost per Passenger Mile (Goyal et al. (2021)).

Aircraft	2-seat	3-seat	4-seat	5-seat
Multirotor	\$19.25	\$14.00	\$12.00	\$11.00
Tilt Duct	\$10.00	\$7.50	\$6.50	\$5.50
Tilt Rotor	\$10.25	\$8.00	\$7.25	\$6.25
Tilt Wing	\$9.75	\$7.25	\$5.50	\$4.90
Lift and Cruise	\$9.90	\$7.50	\$6.00	\$5.10
Compound Helicopter	\$9.25	\$6.45	\$4.80	\$4.75
<i>Average</i>	<b>\$11.40</b>	<b>\$8.45</b>	<b>\$7.00</b>	<b>\$6.25</b>

#### 2.2.4 Ground Infrastructure Requirements

AAM infrastructure not only encompasses physical ground infrastructure for the vehicles (for example, vertiports and vertistops), but also requires the means for traffic management based on digital technology and telecommunications (Fadhil, 2018). Take-off and landing, air traffic control, charging, parking, maintenance, and other facilities are widely accepted as foundational components of the AAM infrastructure network (Booz Allen Hamilton, 2018; CAAM, 2020; Roland Berger, 2018; Porsche Consulting, n.d.).

Dedicated infrastructure will be required for the AAM passenger market to grow over time, and it is anticipated that after appropriate modification existing heliports (and airports) will play a vital role during the early stages of AAM adoption. This is largely due to the wide availability of existing infrastructure, the precedent of helicopters successfully navigating urban environments, and constraints related to affordable or available land in high-density locations (FAA, 2020; Nicklafs et al., 2020; Black and Veatch, 2019) As of February 2020, there were more than 5,800 heliports in the US; however, only a small fraction (approximately 1 percent) was available for public use (Salas, 2021). As the AAM industry evolves, it will require a concerted effort to remediate publicly accessible heliports, construct new vertiports, and create a robust network of vertiports with electric charging capabilities that meet the FAA’s vertiport engineering guidance.

Initial AAM markets will use existing ground infrastructure and primarily serve airport shuttle use cases (Mayor and Anderson, 2019). This will involve transporting passengers from modified existing heliports to an airport (or vice versa). For AAM growth to expand to highly sought-after passenger markets, new vertiport infrastructure will be required.

##### 2.2.4.1 Geographic Coverage Requirements of Vertiports Over Time

A vertiport is a landing pad that enables VTOL operations to touch-down or liftoff of the ground safely. Vertiports may serve as origin, destination, or layover points for charging or refueling. According to the European Union Aviation Safety Agency (EASA), it is likely that vertiport infrastructure will vary in size and quantity among different cities depending on expected travel volumes (EASA, 2021).

Similar to the hub and spoke model used by the airline industry, it is anticipated that UAM will rely on core and feeder vertiports (Rimjha et al., 2021). Core vertiports will exist in dense employment areas, or household locations with a higher-than-average income level, while feeder vertiports will provide service in lower-demand areas (Rimjha et al., 2021). The efficacy of UAM passenger networks will depend on a minimum level of vertiport infrastructure to support the basic needs of those commuting in the urban core or surrounding exurbs (FAA, 2022c).

In large, dense, high-income urban areas, approximately 10-18 vertiports (40-60 landing pads) would be required to facilitate a UAM passenger network (EASA, 2021). This equates to approximately one landing pad for every 46,000 individuals living in these large, dense, urban areas.<sup>3</sup> Meanwhile, medium, less dense, moderate income, urban/suburban areas would require 7-21 vertiports (20-45 landing pads; EASA, 2021), which equates to one landing pad for every 21,500 individuals living in medium, less dense urban areas.<sup>4</sup> Vertiport, landing pad, population, and city characteristics are summarized in Table 2.3.

Table 2.3. Vertiport Estimates of European Cities for Initial Network Efficacy (EASA, 2021).

European City Characteristics	Population	Estimated Vertiports	Estimated Landing Pads	1 Pad per No. of individuals
Large, dense, high-income urban city, e.g., Paris, Berlin, Madrid, Hamburg, Vienna, Barcelona	1.4-3.4 million	10 to 18	40-60	46,000
Medium, less dense, medium income, urban / suburban city, Sevilla, Lisbon, Dusseldorf, Riga, Athens	0.5-0.8 million	7 to 21	20-45	21,500

Source: EASA 2021

Table 2.4. Estimate of Vertiport Requirements by Geography and Time Period.

Study	Region	Time Period	Vertiports Required	
			Low Estimate	High Estimate
EASA (2021)	Large, dense, high-income city	Near-to-Mid Term	10	18
	Medium size and income, less dense	Near-to-Mid Term	7	21
Rimjha et al. (2021)	Northern California	Mid-to-Long Term	75	200
Hasan (2019)	Washington, DC	Mid-to-Long Term	10 distributed hubs with 33 vertiports	
	Large Metropolitan Statistical Areas	Mid-to-Long Term	100	300
	US	Mid-to-Long Term	2,500	3,500
UAM Geomatics (2021)	Worldwide	Mid-to-Long Term	3,060 vertiports	

Sources: EASA, 2021; Rimjha et al., 2021; Hasan, 2019; UAM Geomatics, 2021

Vertiport estimates given by EASA (2021) and shown in Table 2.3 represent the infrastructure requirements for European cities to sustain an AAM passenger market in the near- to mid-term. As the AAM passenger market grows and evolves, it is anticipated that a larger concentration of vertiports will be required. Findings from AAM research demonstrate that an estimated 75-300 vertiports will be required per metropolitan statistical area (Hasan, 2019; Rimjha et al., 2021) and

<sup>3</sup>Derived from EASA, 2021. Estimates were calculated by taking the average from the range of values provided.

<sup>4</sup>See footnote above.

approximately 2,500-3,500 total vertiports will be needed to establish a mature UAM passenger network (Hasan, 2019; UAM Geomatics, 2021). Table 2.4 summarizes these vertiport estimates.

Using the information provided in Table 2.3 and Table 2.4, as well as studies containing AAM market projections<sup>5</sup>, an estimate of vertiport requirements by MSA was developed. Vertiport requirements for evolving, mature, and fully developed markets are shown in Table 2.5. Additionally, the table includes the number of small public airports and heliports within each metropolitan statistical area to demonstrate existing infrastructure that could potentially be leveraged for vertiport development.

New York, Los Angeles, Orlando, Miami, and their respective metropolitan areas are anticipated to operate as the first four launch sites for AAM passenger services in the US, beginning flights as early as 2024 (SMG Consulting, 2021). These nascent markets will then likely be joined by a multitude of other markets. According to market research, approximately 60 metropolitan locations have been cited as potential markets for UAM passenger flights (Haan et al., 2020; UAM Geomatics, 2021; Booz Allen Hamilton, 2018; Mayor and Anderson, 2019; Joby, 2021; Lilium, 2021). Across the US, it is projected that approximately 2,500 to 3,500 vertiports would be required to meet the needs of evolving and mature UAM markets, respectively (Hasan, 2019). Though this requisite level of vertiport infrastructure seems daunting, there are a substantial number of existing sites that could potentially be retrofitted to support UAM passenger networks. For example, if all existing heliport and small public airport sites shown in the UAM markets in Table 2.5 were retrofitted and used, approximately 69.5 percent of the infrastructure needs of these markets would be met in a fully developed UAM network scenario.

---

<sup>5</sup> AAM passenger markets were identified using SMG Consulting, 2021; Haan et al., 2020; UAM Geomatics, 2021; Booz Allen Hamilton, 2018; Mayor and Anderson, 2019; Joby, 2021; Lilium, 2021

Table 2.5. Estimated Vertiport Sites Required for Evolving, Mature, and Fully Developed AAM Networks by MSA.

Metropolitan Statistical Area	Population	AAM Launch Site	CURAM Study	UAM Geomatics Study	Booz Allen Hamilton Study	KPMG Study	Joby Identified Market	Lilium Identified Market	Small Public Airports	Heliports	Potential Existing Sites	Sites for Evolving Network	Sites for Mature Network	Sites for Fully Developed Network
New York-Newark-Jersey City, NY-NJ-PA	19,216,182	x	x	x	x	x	x		16	196	212	254	356	418
Los Angeles-Long Beach-Anaheim, CA	13,214,799	x	x	x	x	x	x		10	193	203	175	245	287
Washington-Arlington-Alexandria, DC-VA-MD-WV	6,280,487		x	x	x	x	x	x	9	58	67	83	116	137
Miami-Fort Lauderdale-Pompano Beach, FL	6,166,488	x	x	x	x	x	x		11	65	76	82	114	134
Dallas-Fort Worth-Arlington, TX	7,573,136		x	x	x	x	x		24	136	160	100	140	165
Houston-The Woodlands-Sugar Land, TX	7,066,141		x	x	x	x	x		10	166	176	94	131	154
San Francisco-Oakland-Berkeley, CA	4,731,803		x	x	x	x	x		7	20	27	63	88	103
Chicago-Naperville-Elgin, IL-IN-WI	9,458,539		x	x		x	x		17	110	127	125	175	206
Philadelphia-Camden-Wilmington, PA-NJ-DE-MD	6,102,434		x	x		x		x	10	136	146	81	113	133
Boston-Cambridge-Newton, MA-NH	4,873,019		x	x		x		x	8	102	110	65	90	106
Orlando-Kissimmee-Sanford, FL	2,608,147	x	x	x				x	4	32	36	35	48	57
Atlanta-Sandy Springs-Alpharetta, GA	6,020,364		x	x		x			18	68	86	80	112	131
Phoenix-Mesa-Chandler, AZ	4,948,203			x	x	x			19	72	91	66	92	108
Denver-Aurora-Lakewood, CO	2,967,239		x	x	x				3	53	56	39	55	65
Detroit-Warren-Dearborn, MI	4,319,629		x	x					11	48	59	57	80	94
Minneapolis-St. Paul-Bloomington, MN-WI	3,640,043		x	x					18	25	43	48	67	79
Baltimore-Columbia-Towson, MD	2,800,053			x				x	4	30	34	37	52	61
Charlotte-Concord-Gastonia, NC-SC	2,636,883		x	x					10	23	33	35	49	57
Portland-Vancouver-Hillsboro, OR-WA	2,492,412		x	x					9	33	42	33	46	54
Las Vegas-Henderson-Paradise, NV	2,266,715		x	x					9	16	25	30	42	49
Cincinnati, OH-KY-IN	2,221,208		x	x					9	35	44	29	41	48
Cleveland-Elyria, OH	2,048,449		x	x					7	37	44	27	38	45
Nashville-Davidson--Murfreesboro--Franklin, TN	1,934,317		x	x					10	16	26	26	36	42
Virginia Beach-Norfolk-Newport News, VA-NC	1,768,901		x	x					4	26	30	23	33	38
Raleigh-Cary, NC	1,390,785		x	x					2	8	10	18	26	30
New Orleans-Metairie, LA	1,270,530		x	x					4	46	50	17	24	28
Salt Lake City, UT	1,232,696		x	x					3	25	28	16	23	27
Hartford-East Hartford-Middletown, CT	1,204,877		x					x	2	30	32	16	22	26
Columbus, GA-AL	321,048		x	x					2	4	6	11	15	18
Seattle-Tacoma-Bellevue, WA	3,979,845		x						13	70	83	53	74	87
San Diego-Chula Vista-Carlsbad, CA	3,338,330			x					11	20	31	44	62	73
Tampa-St. Petersburg-Clearwater, FL	3,194,831			x					7	27	34	42	59	69
St. Louis, MO-IL	2,803,228		x						9	51	60	37	52	61
Sacramento-Roseville-Folsom, CA	2,363,730		x						14	14	28	31	44	51
Pittsburgh, PA	2,317,600		x						8	52	60	31	43	50
Kansas City, MO-KS	2,157,990		x						12	32	44	29	40	47
Indianapolis-Carmel-Anderson, IN	2,074,537		x						9	36	45	27	38	45

Sources: US Census Bureau, 2019; SMG Consulting, 2021; CURAM, 2020; UAM Geomatics, 2021; KPMG, 2029; Joby, 2021; Lilium, 2021; ESRI, 2021

Metropolitan Statistical Area	Population	AAM Launch Site	CURAM Study	UAM Geomatics Study	Booz Allen Hamilton Study	KPMG Study	Joby Identified Market	Lilium Identified Market	Small Public Airports	Heliports	Potential Existing Sites	Sites for Evolving Network	Sites for Mature Network	Sites for Fully Developed Network
San Jose-Sunnyvale-Santa Clara, CA	1,990,660			x					5	7	12	26	37	43
Providence-Warwick, RI-MA	1,624,578							x	8	21	29	22	30	35
Milwaukee-Waukesha, WI	1,575,179		x						4	14	18	21	29	34
Jacksonville, FL	1,559,514		x						6	19	25	21	29	34
Oklahoma City, OK	1,408,950		x						11	23	34	19	26	31
Louisville/Jefferson County, KY-IN	1,265,108		x						3	15	18	17	23	28
Grand Rapids-Kentwood, MI	1,077,370		x						7	4	11	14	20	23
Urban Honolulu, HI	974,563				x				2	9	11	28	39	45
Albany-Schenectady-Troy, NY	880,381							x	2	9	11	25	35	41
New Haven-Milford, CT	854,757							x	3	12	15	24	34	40
Allentown-Bethlehem-Easton, PA-NJ	844,052							x	3	39	42	24	33	39
Dayton-Kettering, OH	807,611			x					4	7	11	23	32	38
Greensboro-High Point, NC	771,851		x						2	2	4	22	31	36
Akron, OH	703,479			x					3	12	15	20	28	33
Poughkeepsie-Newburgh-Middletown, NY	679,158							x	3	23	26	19	27	32
Syracuse, NY	648,593			x					2	6	8	18	26	30
Toledo, OH	641,816			x					8	16	24	18	25	30
Wichita, KS	640,218			x					7	7	14	18	25	30
Harrisburg-Carlisle, PA	577,941							x		18	18	16	23	27
Scranton--Wilkes-Barre, PA	553,885							x	2	19	21	16	22	26
Reno, NV	475,642			x					3	5	8	16	23	26
Atlantic City-Hammonton, NJ	263,670							x	2	11	13	9	12	15
Greenville, NC	180,742		x						1	2	3	6	9	10
<b>Totals from Identified Markets</b>	<b>176,005,336</b>	<b>4</b>	<b>40</b>	<b>37</b>	<b>10</b>	<b>12</b>	<b>8</b>	<b>14</b>	<b>444</b>	<b>2,411</b>	<b>2,855</b>	<b>2,500</b>	<b>3,500</b>	<b>4,105</b>

Sources: US Census Bureau, 2019; SMG Consulting, 2021; CURAM, 2020; UAM Geomatics, 2021; KPMG, 2029; Joby, 2021; Lilium, 2021; ESRI, 2021



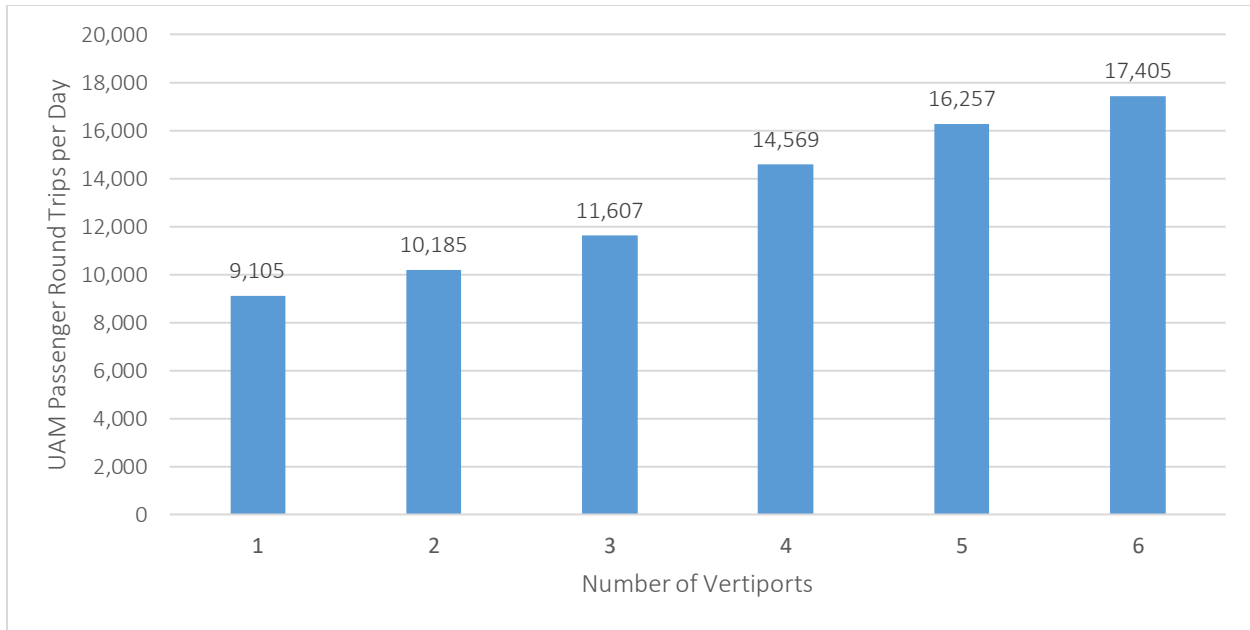

Figure 2.7. Vertiports and Passenger Demand in Northern California (Rimjha et al. 2021).

Vertiports will play a critical role in supporting AAM passenger market demand. The more locations that exist for VTOL operations, the greater the convenience of AAM passenger transport, and the greater the likelihood of user adoption. A commuter demand analysis by Rimjha et al. (2021) assesses the importance of vertiports in round-trip daily UAM passenger flight. The analysis assumes a user cost of \$1.80 per mile in North California. Within this region, if 50 vertiports were to exist, daily UAM demand would reach 9,105 round-trip flights. However, if vertiport investment were to increase so that 400 vertiports would exist in the region, demand would nearly double. An estimated 17,405 daily round trips would result, as shown in Figure 2.7.

Though outside the scope of this research, it is important to consider whether the public or private sector would internalize the capital costs associated with vertiport construction. As a point of comparison, automobile travel is made possible through extensive road networks that are primarily constructed and maintained through public investments or public-private-partnerships generated by motor fuels taxes, sales taxes, tolls, general fund appropriations, or bonds, among other revenue sources. The approaches used to fund vertiports and AAM enabling infrastructure will have a notable effect on market adoption rates. The recent proposal for the Advanced Aviation Infrastructure Modernization Act, which passed the US House of Representatives on June 14, 2022, provides a starting point for addressing how to fund vertiports (eVTOL, 2022).

#### 2.2.4.2 Vertiport Site Specifications

In the US, it is expected that the average vertiport would be capable of accommodating 3-6 vehicles at one time and expected to range from 24,000 to 50,000 square feet (Hasan, 2019). Vertiports will include landing areas and additional space that will enable passengers to embark, disembark, and allow vehicle fueling, charging, or battery swap (Hasan, 2019; Black and Veatch, 2019). Considering the high volume of vehicle landings on each structure, it is anticipated that a vertiport will have a useful life of 10-20 years (Hasan, 2019).

At-grade take-off and landing areas will likely be the most common vertiport treatment implemented during the short- to medium-term. These treatments may involve retrofitting regional airports and helipads, which would require relatively minimal structural analysis compared to the installation of a new at-grade vertiport structure (Black and Veatch, 2019).

Rooftops and other elevated take-off or landing areas may also serve as important locations for vertiports. High-rise buildings with existing helipads have great potential to serve as vertiports, as they already have much of the necessary existing infrastructure to support AAM services. These buildings, as well as the top of parking garages, could potentially be retrofitted to support eVTOL operations. The types of vertiport infrastructure and their associated costs are shown in Table 2.6.

Black and Veatch (2019) conducted an industry-wide investigation to understand battery and charging technologies for eVTOLs. While eVTOLs currently in development are estimated to be able to charge at a maximum of 350kW, it is expected that eVTOL vertiport infrastructure should possess the capacity to utilize 600kW chargers (Black and Veatch, 2019). This will futureproof the design of the infrastructure required, as renovation of a site to increase its individual charger capacity would effectively require full-site demolition and reconstruction (Black and Veatch, 2019).

Table 2.6. Vertiport Infrastructure and Associated Costs (Black and Veatch, 2019).

Type	Description	Estimated Cost (2022 USD)*
Ground landing site without charging stations	3 Landing Pads, 0 Chargers	\$397,000
Existing rooftop landing site with charging station install	1 Landing Pad, 1 Charger	\$1,002,000
Existing parking garage with charging stations	3 Landing Pads, 3 Chargers	\$2,128,000
Ground landing site with central charging station only	3 Landing Pads, 1 Charger	\$2,903,000
Ground landing site with charging stations	3 Landing Pads, 3 Chargers	\$2,983,000

\*Estimated cost values have been adjusted from 2018 to 2022 dollars

### 2.2.5 Competition for UAM Passenger Services

Emerging UAM technologies have the potential to disrupt several sectors, but these sectors also have strong existing competitors. UAM services are expected to enter the markets for short journeys (as air taxis), trips to and from airports, regional air travel, and ambulance services. However, in all of these use cases, the new entrants will face entrenched incumbents, some of which have significant advantages in certain parameters. Moreover, other emerging technologies, such as ground-based Autonomous Vehicles (AVs), may concurrently enter the market, further heightening the competition AAM services will face. Finally, there is a small but substantial subset of passengers that is resistant to any of the emerging technologies and that will continue to prefer to take traditional modes (Garrow et al., 2020). These travelers will be among the last to adopt UAM travel if they do so at all.

One of the most promising use cases for emerging UAM technologies is as an air taxi service in congested urban areas. Although a potentially large market, it is also a market with many competitors that are already being used to make trips of similar distance and frequency. Widespread alternatives to air taxis already exist in the forms of personal automobiles, public transportation systems, and ride-sharing/taxis/TNC services. The most formidable competitors of the existing modes of transport are shown in Figure 2.8, which demonstrates hypothetical price points and travel times that would likely enable Joby services to become viable. In addition to these traditional competitors, a UAM air taxi service could face notable competition from other

emerging technologies such as ground-based AVs, which are poised to offer a service with many (though not all) of the same benefits at a lower cost.

To compete with these alternatives, an air taxi service must offer door-to-door travel time savings. While eVTOL aircraft may operate at speeds between 100 mph to 150 mph in urban areas, time spent within the UAM vehicle is not the only component that needs to be considered. A passenger will need to travel to the vertiport, potentially wait for a vehicle or other passengers, board the eVTOL vehicle, travel in the vehicle, alight at the destination, exit the vertiport, and travel to his or her final destination. Studies in a diverse range of settings have consistently found that potential market share for UAM service is sensitive to access and egress times to and from the vertiport, as well as time spent waiting for, boarding, and disembarking the aircraft (Kreimer et al., 2016; Swadesir & Bil, 2019; Garrow, et al., 2020; Bulusu et al., 2021). Many conceptions of air taxi services envision vehicles in urban cores departing and arriving from buildings or parking structure rooftops (see, e.g., Boddupalli et al., 2018); it is likely that simply the time spent by passengers beginning or ending their journeys at these facilities in reaching the vertiport from ground level will be substantial. Given these time costs, many passengers making short journeys would save no time at all by choosing to use an air taxi (and therefore presumably would not choose to do so); time savings are generally only possible with journey distances of 15 to 25 kilometers or more (Roland Berger, 2018).

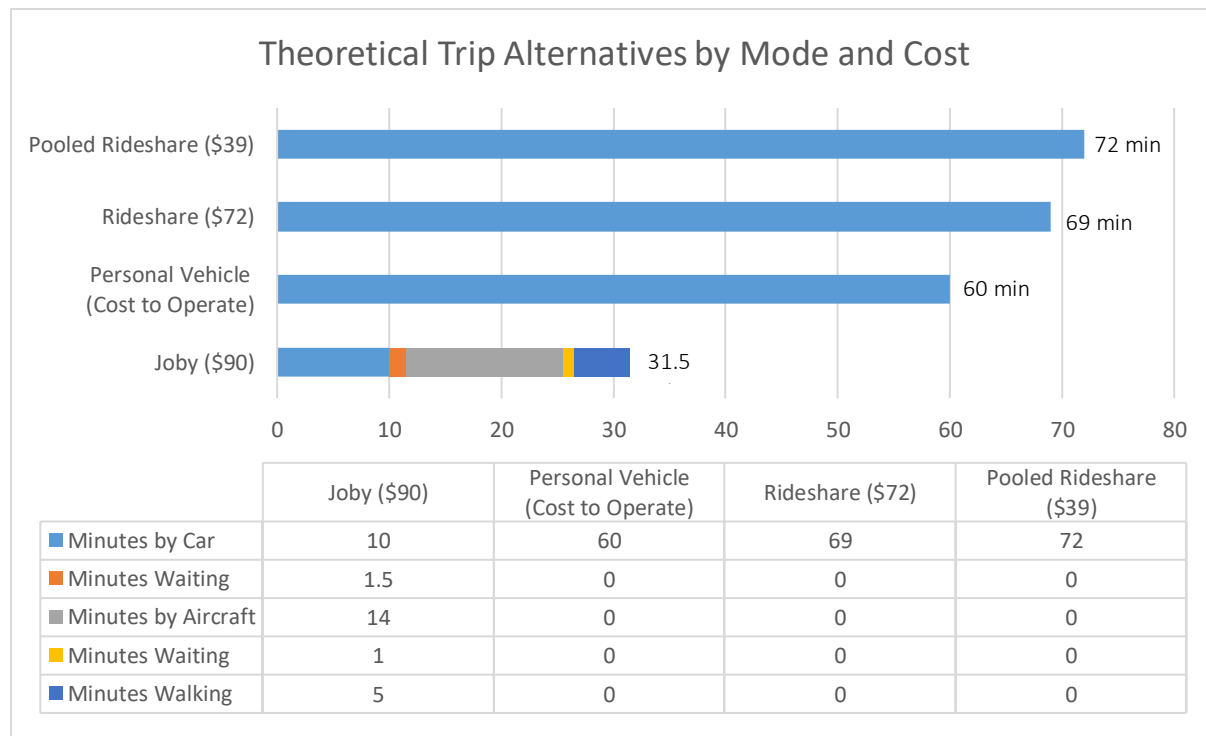

Figure 2.8. Example Mode Choice Scenario Presented to Joby Survey Participants (Joby, 2021).

The COVID-19 pandemic, too, may have shifted the competitive landscape for air taxi services. Garro, Roy, and Newman (2020) have found that individuals are less likely to choose to travel in an air taxi (as well as in an AV) that is shared with strangers, and this is especially true of younger people. However, the survey data underlying this and other research into sharing vehicles was conducted pre-pandemic, and it is not yet clear how attitudes to sharing a vehicle have changed in

light of new norms and attitudes surrounding public health. A further shift in public attitudes away from sharing vehicles may necessitate future air taxi service providers to move towards offering more expensive private services and fewer shared services and therefore may further shrink the size of the potential market for UAM. Unclear, too, is how the pandemic has shifted long-term travel patterns, especially for daily commutes. It is, of course, possible that the disruption to commuter travel patterns due to the pandemic will prove to be an aberration and that past patterns will return; however, even a modest change in the number of high-income, long-distance commuters could cause significant complications for the business plans of future UAM operators. Higher-income commuters who live far from their workplaces and value the ability to complete other tasks while traveling to and from work have been considered a core demographic for designing UAM air taxi services; these individuals, however, are among the most likely to have jobs that are well-suited to hybrid or fully remote work arrangements and, living so far from their traditional workplaces, are among those who would benefit the most from such arrangements. Conversely, there may be a large increase in the number of high-income, hybrid workers who will wish to live further from their workplace while also benefiting from, and being willing to pay for, a faster trip via air taxi for those times when they do need to go to the office.

#### **2.2.5.1 Private Automobiles**

The most obvious competition for an air mobility service is private automobile travel, by far the dominant form of transportation for journeys to and from work in the US. The market for automobiles in the US is saturated with an estimated 290 million registered vehicles in 2021 (Hedges & Company, 2022). Although the car market is highly saturated, it's important to note that vehicle ownership is often restrictive for low-income households. According to the Bureau of Transportation Statistics (2011), households with an annual income of less than \$25,000 are almost nine times as likely to be a zero-vehicle household than households with incomes greater than \$25,000. Turnover times for the vehicle fleet are long: the average age of vehicle use in the US is 12.1 years (Ferris, 2021). As both a cause and a consequence of this, the North American built environment has been shaped in a way that significantly favors travel by personal automobile, giving this mode a large fixed-infrastructure advantage. While air taxi users may face significant access and egress times traveling to and from vertiports, the overwhelming majority of origins and destinations in the US have vehicle parking readily available, often at no or a low cost. Further, as Bulusu et al. (2021) point out, by choosing to take an air taxi, a commuter will lose the flexibility to travel between destinations by car after (and possibly before) his or her eVTOL journey (Bulusu et al., 2021); in many American cities, the inability to easily access locations other than the initial destination could prove to be a significant drawback to using an air taxi. Further, even considering the total cost of ownership, private automobiles are likely to remain considerably cheaper in the long term. Booz Allen Hamilton predicts that air taxi journeys are likely to cost \$6.25/mile at first, with the potential to decrease to \$3.75/mile in the long term (Reiche et al., 2018). By contrast, the average ownership cost, including all expenses, for a car driven 10,000 miles per year is \$0.83/mile and for a car driven 15,000 miles per year is \$0.64/mile (AAA, 2021); the average car or light truck travels 11,500 miles per year (AFDC, 2020).

#### **2.2.5.2 Ridesharing/Taxis/TNCs**

Interest in air taxi services is higher among frequent patrons of “ridesharing” services such as Uber and Lyft (Boddupalli et al., 2020). However, ridesharing already has a broad, established user base: in focus groups conducted in Washington, DC, and Los Angeles, 60 percent of respondents

mentioned ridesharing services as a preferred travel mode for non-work trips (Reiche et al., 2018). The premium these respondents were willing to pay for an air taxi, however, varied, with some willing to pay only 10 to 20 percent more while others were willing to pay larger premia, such as \$25-40 per trip (Reiche et al., 2018). Before selling its eVTOL development unit to Joby Aviation, Uber estimated that, considering travel times, operating expenses, and emissions, air taxi fares would ultimately be competitive with its traditional ground-based ride-hailing service (Holden & Goel, 2016).

### **2.2.5.3 Other modes of transportation**

Because of the distances involved and rider demographics, air taxis are unlikely to compete directly with traditional bus services. However, at intermediate distances, air taxis may compete with urban heavy rail transit systems and commuter rail systems for some journeys in the metro areas where these systems exist.

### **2.2.5.4 Air ambulance services**

Urban air mobility aircraft are also being considered for air ambulance services. UAM is envisioned to be a potential competitor both to traditional air ambulance services and ground ambulance services. However, an analysis by Booz Allen Hamilton found that UAM air ambulances would have similar costs to existing rotary-wing (i.e., helicopters) and fixed-wing providers, in part due to high non-pilot staffing requirements, and would have much higher costs than ground ambulances (Reiche et al., 2018). Ultimately, the analysis concluded that UAM ambulance services will struggle to compete with fixed-wing air ambulances due to the range requirements required and with ground ambulances due to much higher cost.

Legislative changes also introduce new revenue risk to the US air ambulance sector that was not accounted for in previous analyses. Air ambulance services are provided only rarely, and their clients are highly inelastic. Not coincidentally, their operators are rarely in-network participating providers with commercial insurance plans, and so over three-quarters of their patients are billed on an out-of-network basis (Fuse Brown et al., 2020). Air ambulance services are also preempted from state and local price regulation by the Airline Deregulation Act (Fuse Brown et al., 2020). With the ability to set charges free of state and local regulation, with little incentive to participate in insurer contracts, and with a customer base that has little choice about using its services, the median standard charge set by a rotary-wing air ambulance provider is 5.3 times the Medicare billing rate, an unusually high ratio (Bai et al., 2019). These lucrative aspects of the air ambulance market have also made it attractive to private equity firms: PE-owned providers controlled over 60 percent of the rotary-wing market for Medicare patients in 2017, and their standard charges are 67.5 percent higher than those of non-publicly or PE-owned providers (Adler et al., 2020). However, these lucrative aspects for investors also attracted attention from Congress, which passed the “No Surprises Act” as part of the second coronavirus relief package in December 2020. As of January 1, 2022, the law will force insurers and air ambulance providers to engage in binding, final offer (or “baseball-style”) arbitration (Adler et al., 2021). Among other factors, arbitrators are specifically instructed to consider existing in-network rates, the market share of the provider and insurer, and the type of vehicle used (Adler et al., 2021). Existing state arbitration systems tied to in-network rates do not tend to be especially favorable to providers (Adler et al., 2021), and the explicit instruction to consider vehicle type and market concentration may also be damaging to existing air ambulance providers seeking to use AAM vehicles. A mitigating factor working in favor of providers is that the existing in-network rates for air ambulance services are inflated by

the leverage that providers hitherto held over insurers and patients (Fuse Brown et al., 2021). Overall, however, air ambulance providers will likely experience a negative impact on revenue compared to the status quo, and this may further damage the prospects of AAM air ambulance services.

### ***2.2.6 COVID-19 Related Impacts on UAM Passenger Markets***

The COVID-19 pandemic caused the global economy to contract by 3.5 percent in 2020, making it the deepest global recession since the end of World War II (Yeyati and Filippini, 2021). Industrial production, manufacturing, and world trade volumes all decreased substantially during 2020, and supply chain disruptions and talent shortages are cited as the top risks to company growth in 2021 and 2022 (McKinsey & Company, 2021a,b).

The global pandemic has had an unprecedented impact on all industries with notable setbacks in research and development for advanced air mobility (Santha, 2020). This can be attributed to the substantial setbacks experienced by the aviation industry, which contracted an estimated \$84 billion in 2020 (Santha, 2020). Since most of the major advanced passenger mobility players are directly or indirectly related to the aviation sector, the pandemic has had a ripple effect on this sector (Mordor Intelligence, 2021).

Prior to the onset of the pandemic and in the first few months of 2020 alone, over \$1 billion was invested in advanced air mobility, with Toyota leading a \$590 million investment in Joby and EHang undergoing its IPO at \$650 million (Santha, 2020). However, with the onset of the COVID-19 pandemic, advanced passenger mobility experienced setbacks. Before being acquired by Joby, Uber Elevate disclosed that remote working has impacted the ability of their vehicle partners to conduct research and development activities (Santha, 2020). Additionally, labor and supply chain disruptions were noted by EHang as hampering overseas development (Santha, 2020). Core perceptions shaped by the COVID-19 pandemic, and their duration, are difficult to fully understand, but could potentially affect the willingness of consumers to travel in confined spaces, such as an eVTOL.

The COVID-19 pandemic has also fundamentally changed people's work and travel patterns. Prior to the pandemic, less than six percent of Americans worked primarily from home; however, in May 2020, more than one-third of employed Americans worked from home (Coate, 2021). If the work from home trend continues, surface level peak congestion periods may ease. Though beneficial for vehicular travel, congestion reduction may have a negative impact on the AAM market.

The revenue impacts of the pandemic can be witnessed through changes in market forecasts made before and during the global pandemic. For example, UAM Geomatics released a series of three market forecasts for UAM passenger flight services in the US in 2019, 2020, and 2021, which had notable differences in projections from one year next, as shown in Table 2.7 and Figure 2.9. US

advanced passenger mobility cumulative revenue forecasts for the year 2045 were revised from \$155.6 billion to \$130.9 billion--a reduction of 18.8 percent.<sup>6</sup>

Table 2.7. Revenue Forecasts - Before & During the Pandemic (UAM Geomatics, 2019-2021).

Year	Cumulative Revenue			% Change (SY2019-SY2021)
	SY2019*	SY2020*	SY2021*	
<b>2022</b>	\$1,543,200,000	\$614,400,000	\$169,500,000	810.4%
<b>2025</b>	\$15,851,000,000	\$7,167,600,000	\$2,974,000,000	433.0%
<b>2030</b>	\$34,143,500,000	\$24,460,200,000	\$19,453,400,000	75.5%
<b>2035</b>	\$59,580,800,000	\$47,427,700,000	\$42,709,700,000	39.5%
<b>2040</b>	\$93,225,600,000	\$83,139,800,000	\$77,470,000,000	20.3%
<b>2045</b>	\$155,600,700,000	\$143,758,200,000	\$130,980,000,000	18.8%

\*SY is an abbreviation for study year

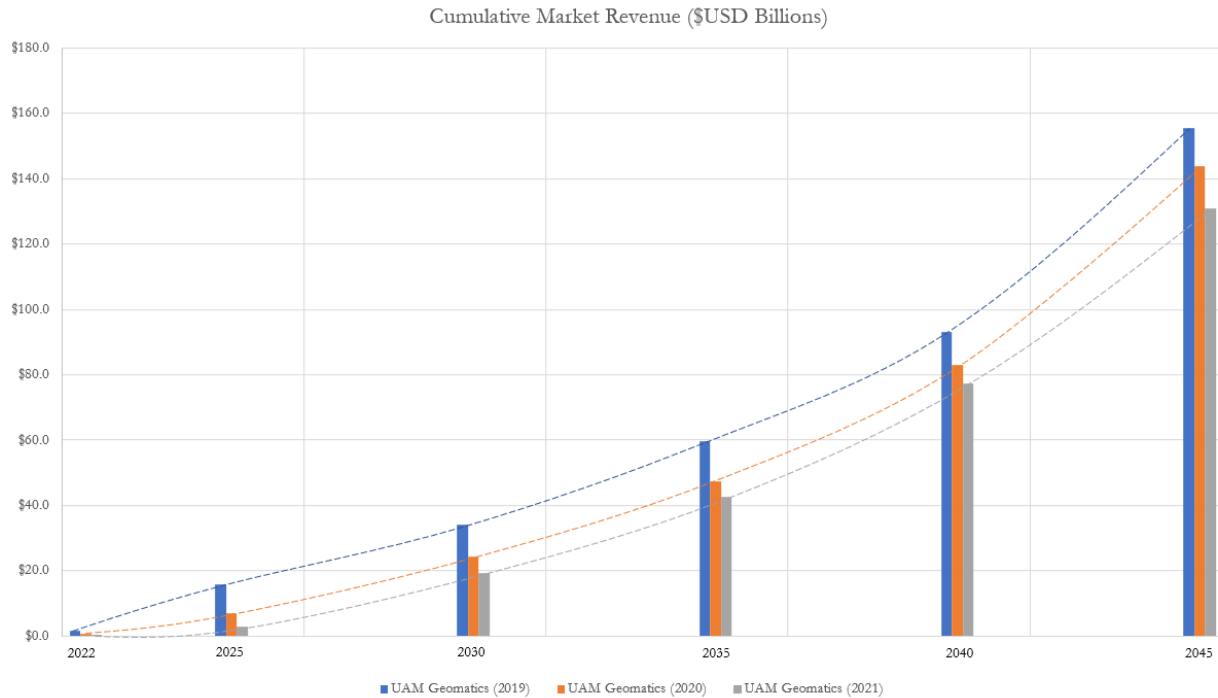

Figure 2.9. Revenue Forecasts - Before & During the Pandemic (UAM Geomatics, 2019-2021).

<sup>6</sup> The ASSURE A41/A42 research team analyzed US city revenue estimates available on the UAM Geomatics online dashboard. Revenue estimates were available for year 2021. Revenue estimates were then fitted to previous study years by comparing global revenue estimates in 2021 to global estimates in study years 2020 and 2019. Global revenue estimates from all study years could then be used to chain US market share in 2021 (identified in the 2021 UAM Geomatics online dashboard) to estimates of US market share in study years 2020 and 2019.

Among study release years, short-term differences in cumulative revenue projections were the most prominent. Cumulative revenue forecasts for the year 2022 declined by 810 percent from study year 2019 to 2021 and forecasts for the year 2025 fell by 433 percent. Though a direct explanation was not provided by the study authors for their amended projections, substantial economic setbacks resulting from the pandemic shed light on the divergence between the authors' anticipated advances in the industry and the post-pandemic reality. According to the study authors, several essential advances would need to occur to enable UAM development, as cited below:

*The next decade (2021-2030) will be critical to the design, launch and acceptance of the UAM Industry. During this decade, standards for safety, security, interoperability, UATM architecture, and noise will become crucial... This decade will provide a proving ground for aircraft manufacturers to refine and certify an array of eVTOLs including all-battery, hybrid electric and hydrogen cell based designs.*

Some of the critical path components for UAM advancement have been halted or notably delayed due to the onset of the pandemic. This especially includes the acceptance of the UAM industry. A survey by the International Air Transport Association (IATA, 2020) found that the willingness to travel by air will be significantly decreased in the near future due to safety and social distancing precautions. Though this survey was intended for traditional air travel, its findings are also relevant for UAM services. In addition to public acceptance setbacks, UAM aircraft manufacturers were notably impacted by supply chain disruptions and research and development challenges (Santha, 2020; Mordor Intelligence, 2021; McKinsey & Company, 2021a,b). With a number of market factors at play, the change in market projections between UAM Geomatics study release years can help shed light on the large influence of the pandemic.

Despite the challenges imposed by the pandemic, there are strong signals that the advanced air mobility industry is recovering. In 2021, the industry attracted \$7 billion in new investment—more than doubling the total disclosed investments made over the previous decade (Esqué and Riedel, 2022). Five UAM passenger mobility companies went public in 2021—Blade Air Mobility, Joby Aviation, Lilium, Archer Aviation, and Vertical Aerospace—all through mergers with special purpose acquisition companies (SPACs), with a combined market cap of \$10.7 billion (Esqué and Riedel, 2022). Furthermore, in accordance with the strong medium- and long-term market projections that preceded the pandemic, the AAM industry may see strong investments continue as the industry furthers its recovery.

SMG Consulting (2022) may provide the most comprehensive snapshot of UAM industry growth. It tracks the OEMs that have received significant investment from venture capital, private equity, SPACs, automotive companies, legacy aerospace OEMs and tech companies. Investments are summarized in Table 2.8.



Table 2.8. AAM Industry Investments (SMG Consulting, 2022).

OEM (stock ticker)	Funding (\$M)	Use Case	First Flight	EIS	Country
Joby Aviation (NYSE: JOBY)	\$1,844.60	Air Taxi	2018	2024	USA
Volocopter	\$579.00	Air Taxi	2021 / 2022	2024 / 2026	Germany
Beta Technologies	\$796.00	Cargo, Air Taxi	2020	2024	USA
Lilium (NASDAQ: LILM)	\$938.00	Regional, Cargo, Biz Av	-	2025	Germany
Wisk	\$775.00	Air Taxi	2018	-	USA
Archer (NYSE: ACHR)	\$856.30	Air Taxi	2021	2024	USA
Ehang (NASDAQ: EH)	\$132.00	Air Taxi, Tourism	2018 / 2021	2022 / -	China
Kitty Hawk	Privately funded	Air Taxi	2018	-	USA
Vertical Aerospace (NYSE: EVTL)	\$337.30	Air Taxi, Cargo, EMS	2022	2025	UK
Airbus	Corporate backed	EMS, Tourism, Air Taxi	2023	2025	France
Eve Holding (NYSE: EVEX)	\$362.40	Air Taxi	2022	2026	Brazil
Supernal	Corporate backed	Air Taxi	2023	2028	South Korea
Overair	\$170.00	Air Taxi	2023	2026	USA
Honda Motor Company	Corporate backed	Air Taxi	2023	2030	Japan
Evation	\$200.00	Regional, Cargo, Biz Av	2022	2025	USA
REGENT	\$27.00	Regional	2023	2025	USA
AutoFlight	\$200.00	Air Taxi	2022	2025	China
Dufour Aerospace	\$11.00	EMS, Regional	2022	2026	Switzerland
Electra	\$49.00	Regional, Air Taxi, Cargo	2022	2027	USA
Ascendance Flight Technologies	\$11.90	Regional, Cargo	2023	2025	France
Jaunt Air Mobility	\$3.10	Air Taxi	2023	2026	USA

Aviation OEMs, suppliers, and operators have been taking public steps to help scale and develop the UAM industry. By the end of 2021, five of the ten largest aerospace OEMs had publicly launched UAM programs or made investments in other players (Esqué and Riedel, 2022). Among major suppliers, the share was even higher, with seven of the ten largest aerospace suppliers publicly active in the space (Esqué and Riedel, 2022). Additionally, even among the ten largest airlines, four have publicly entered the advanced passenger mobility space (Esqué and Riedel, 2022).

The UAM industry is receiving aircraft purchase orders and letters of intent that reflect increasing demand. The industry received orders and letters of intent in 2021 for approximately 6,850 aircraft worth \$26.1 billion—outpacing the order volume for conventional aircraft orders that year by a factor of ten (Esqué and Riedel, 2022). Many of these orders are conditional and non-binding, but the spike in order volume is a clear signal of recovery, demonstrating interest from a range of players, including important aviation industry incumbents (Esqué and Riedel, 2022).

## **2.2.7 Market Segmentation Analysis**

### **2.2.7.1 Segmentation Overview**

The literature review summarized market information for AAM mobility operations from a wide range of sources, including industry research, academic papers, and government-funded research. The literature review included summary analyses on the market potential for AAM, the costs of entry and operational viability, the competitive environment, consumer acceptance, public acceptance barriers, and legal and regulatory barriers.

The segmentation analysis contained in this section builds on this work and combines academic work with industry reports, data on advanced passenger mobility, and media coverage to give further insight into the AAM market.

First, an overall summary is given of the potential customer base for the major advanced passenger mobility markets. The markets included are UAM and RAM. First, a high-level overview is given of each segment, along with a summary of the market potential for each segment of the market. Following this, analysis is given that aggregates demand forecasts for the previously described segments, and then some analysis is given of subsegments in the overall segmentation market.

The process of segmentation can be thought of as a “mix of art and science”. A wide range of segmentation procedures has been developed over the last fifty years to segment both perceptual and behavioral customer data (France & Ghose, 2019). Methods of segmentation include a range of clustering methods (e.g., Punj & Stewart, 1983) and model-based latent class approaches (e.g., Grover & Srinivasan, 1987). However, purely technical segmentation solutions that are not grounded in business realities may have limited usefulness in predicting customer behavior (Yankelovich & Meer, 2006). Technical methods can be combined with business intuition and domain-specific knowledge to ensure that segmentation solutions are realistic and have face validity. For example, Barron and Hollingshead (2002), noted the need for broad multi-disciplinary teams to increase the applicability and validity of segmentation solutions.

The segmentation approach followed in this paper is designed to be qualitative and descriptive in that it gives information on different market segments with information summarized from the literature review and other sources. However, where suitable data are available, technical segmentation is used to provide additional information on segmentation structure and summaries of past reports are used to give summary predictive estimates of market potential.

### **2.2.7.2 Macro Consumer Segmentation**

Consumer market segmentation can be thought of as the process of splitting a consumer market into subsets of more homogenous consumers (Smith, 1956) and is used to better target the marketing effort (in terms of product, price, place, and promotion) to specific groups of consumers. The market can be split using different consumer characteristics, which in the context of segmentation are called “segmentation bases”. Segmentation bases can include a wide range of variables, including, but not limited to, psychographic characteristics (e.g., beliefs about travel safety), behavioral characteristics (e.g., trip frequency and distance), lifestyle characteristics (e.g., preferred leisure activities), socio-economic characteristics (e.g., income) and demographic characteristics (e.g., age). Dhalla and Mahatoo (1976) noted that no one type of segmentation base can fully describe consumer characteristics; for example, purely psychographic segmentation cannot adequately predict customer purchases and behavioral segmentation on purchase data cannot account for customer motivations. A key point is that segments must respond differently

to marketing efforts. For example, a promotion targeted to a certain segment should elicit different behavior in that segment than in other segments. The “differential behavior” is just one desirable attribute of a consumer segment. A segment should be identifiable, sizeable, accessible, stable, actionable, and responsive (Kotabe & Helsen, 2021). These attributes are explained in Table 2.9 with examples related to the market for AAM.

Table 2.9. Segmentation Characteristics.

Characteristic	Description
Identifiable	The segment can be defined in terms of travel distance. Larger, out-of-metro travel will come under the banner of RAM while shorter distance travel will come under the banner of AAM.
Sizeable	Several sources cited in the market analysis show the potential size of the AAM mobility, for example, the survey by NASA and McKinsey (McKinsey & Company, 2021c). To be commercially viable, a segment must have enough potential consumers to be profitable.
Accessible	The segments can easily be targeted. For example, if a segment of consumers did not have access to the internet, they would not be able to access online ticket promotions.
Stable	Is the segment stable? A stable segment is easier to target. However, for a new product, this may not be possible (or desirable). For example, the segment of consumers interested in utilizing AAM would need to grow rapidly for AAM to be viable.
Actionable	Can the marketing effort be adapted to the segment while keeping alignment with core competencies? For example, there may be a segment of cost-conscious budget travelers.

The market segmentation analyses in this document utilize the characteristics described in Table 2.9 but in the context of determining overall market potential rather than just targeting a specific commercial product or service to a market. The sizeable characteristic is particularly important, as it is directly related to overall market potential. All the described segments will be described in terms of consumer attributes, so should be identifiable. Potential market segments will be evaluated in terms of accessibility and actionability. As these concepts overlap, they are combined. In addition, though cost can be analyzed with respect to customer accessibility, given the importance of cost information to the viability of AAM operations, a cost attribute is given as a standalone segmentation criterion. Given the context of implementing a new product/service, the segment stability characteristic is less important than the other characteristics, though some analysis is given of the market potential of the segment over time.

### 2.2.7.3 UAM (Urban Air Mobility)

Urban Air Mobility refers to the segmentation of within-metro urban trips. UAM can encapsulate a range of airport trips including air taxi trips, airport commuting trips, and leisure trips.

#### 2.2.7.3.1 *Identifiable*

Using the *Booz Allen Hamilton NASA Study* (referred to as the BAH\_NASA study), UAM can be thought to encapsulate trips of less than 50 miles. Different studies have defined the boundaries of UAM in different ways. For example, the BAH\_NASA study and associated publications (Booz Allen Hamilton, 2018; Goyal & Cohen, 2022; Goyal et al. 2021; Reiche et al., 2018) focus on UAM as a commuter transportation and airport shuttle service. The Morgan Stanley (2018) report gives a much broader scope of operations, and include a range of customer applications (e.g., shared ride air taxi) and also cargo and military applications. For the purpose of this analysis, UAM is defined as an customer carrying air mobility application using electric or hybrid eVTOL vehicles (either piloted or autonomous), within an urban metro area and with a trip range of less than 50 miles.

#### 2.2.7.3.2 *Sizeable*

There are multiple estimates of market size available for the potential UAM market. Though these estimates, may differ slightly in time period and scope, there is some commonality between the estimates. Several of the estimates are outlined below and a summary is made of some of the general trends. A more detailed analysis is carried out in the demand estimation section of this paper. Most of these estimates assume a commercial start date around the period 2023-2025, with Blade, Archer, EHang, Volocopter, Joby, and Lilium planning to launch operations within this period (Research and Markets, 2021b; SMG Consulting, 2021). Only US-wide forecasts are included.

- From a commercial study (Research and Markets, 2021), it was estimated that the US UAM market will grow to \$18.81 billion by 2035, with a compound annual growth rate of 23.12% from 2023-2035.
- A case study by Morgan Stanley (2018) found that for a base case, for the US, the Total Addressable Market (TAM) for UAM will be \$2 billion in 2025, \$12 billion in 2030, \$66 billion in 2035, \$279 billion in 2040, \$1081 billion in 2045, and \$2450 billion in 2050. This analysis gives a broad overview of overall market potential and assumes penetration in many different subsegments of the market including shared-ride taxi, commuter services, and includes potential goods transportation and military revenue.
- In the BAH\_NASA study and associated publications (Goyal & Cohen, 2022; Goyal et al. 2021; Reiche et al., 2018), it is stated that combined, the Air Taxi and Airport shuttle markets have a potential demand of 55,000 daily trips (82,000 daily passenger). This results in an unconstrained demand of 11 million daily trips with a market size of approximately \$500 billion. With constraints, it is estimated that UAM can account for 0.1 percent of total daily commuter trips and will have a market value of \$2.5 billion, with potential for 4,000 operational aircraft.
- The survey by KPMG (Mayor and Anderson, 2020) takes a conservative approach to demand estimation. It has an assumption of full commercialization of UAM services starting in the 2030s, with estimated global passenger enplanements of 12 million per year by the end of the 2030s, increasing to 400 million per year by 2050.
- UAM Geomatics created multiple demand estimates through year 2050 (UAM Geomatics 2021a,b). These demand estimates were analyzed, synthesized, and combined as part of the Site Suitability Analysis (SSA) and staggered based on known commercial start dates.

Overall estimates are approximately 300,000 flights in 2025, 6 million in 2030, 14 million in 2035, 35 million in 2040, and 68 million in 2050.

Overall, this section has summarized a wide variety of demand estimates. These estimates used very different methodologies and produced quite different results, but there are some commonalities within the estimates. The forecast start dates ranged from 2022-2030. Though there is some uncertainty as to commercialization dates, initial implementations are seen in 2024-2025 (see accessible/actionable section). In most of the forecasts, the 2030s are seen as a major ramp-up period, where UAM transitions from isolated metros to a more integrated system, with the full potential of UAM realized in the 2040s.

#### *2.2.7.3.3 Accessible/ Actionable*

The accessibility/actionability of this segment depends on i) sufficient infrastructure to support UAM services, ii) commercial deployment of UAM services, and iii) regulatory/government support via the FAA and other agencies that will allow UAM services to be integrated into the NAS. Cost considerations are important to accessibility, though these are discussed in the next section.

A primary infrastructure consideration is the placement of UAM flight departure/arrival locations. UAM specific facilities are often referred to as “vertiports”. Guzzetti (2021) noted that while initial UAM implementation may be able to use existing infrastructure, such as heliports/airstrips, for UAM to be commercially scalable, dedicated “vertiports” would be needed with infrastructure and charging stations.

Guzzetti (2021) also noted that in conjunction with regulatory authorities, a viable UAM service would need a specific corridor within the NAS. The FAA defined the concept of such a corridor in the UAM CONOPS (v.1) report (FAA & NASA, 2020). Here a UAM corridor is defined by the FAA as “a performance-based airspace of defined dimensions in which aircraft abide by UAM specific rules, procedures, and performance requirements”.

There has been a range of initial academic work on the development of vertiport infrastructure. Examples of this work include analyses of vertiport development and capacity based on operational constraints (Guerreiro et al., 2020; Rimjha & Trani, 2021; Vascik & Hansman, 2019), vertiport location selection and optimization (Chen et al. 2022; Daskilewicz et al. 2018; Shao et al. 2021; Venkatesh et al., 2021), and UAM airspace design/vertiport integration (Song et al., 2021). In addition, the FAA has recently produced an engineering brief for vertiport design (FAA, 2022c). This brief gives guidance in areas such as vertiport design, electrical infrastructure, and site safety. It is expected that this guidance will be updated once further knowledge is gained from initial vertiport implementations. NASA, in conjunction with commercial partners, have also produced a comprehensive report on vertiport implementation (NASA, 2021c). The report has an operations orientation and gives guidance for operational management and collaboration between partners and for integration of vertiport integration into the NAS. In total, this work helps provide the foundations for moving the concepts of vertiports forward.

The ability to implement UAM solutions will depend on the commercial support and infrastructure for these solutions. There are several current commercial projects to bring eVTOL UAM to the US market. The four most realistic implementations in the US, chosen using the AAM reality

index (SMG Consulting, 2021), are listed below. Only implementations that include proposed infrastructure at specific locations are listed/included.

- Joby Aviation has obtained Part 135 Certification from the FAA to run air taxi service and aims to have full FAA vehicle certification and initial flight implementation by 2023 (Joby, 2022b). The trip from Los Angeles to Newport Beach is stated as a potential initial route (Alamalhodaie, 2021b). In addition, Joby has partnered with a parking garage operator, REEF, to allow vertiports to be built on top of garages (Dahlberg, 2021b) and may additionally look at the San Francisco, Miami, and New York markets.
- Lilium (Parker, 2021) has invested approximately \$20 million in a vertiport at Lake Nona in Florida. The plan is to begin initial service in 2025. This development has RAM aspects, as Lilium eventually hopes to build a RAM infrastructure (Alcock, 2020).
- Archer Aviation is aiming to enter the Miami and Los Angeles markets with a shared-ride air taxi service in late 2024 (Dahlberg, 2021b). The services are designed for journeys from 10 miles to 50 miles. There are no specific vertiports mentioned in the article, though as with Joby, Archer has partnered with REEF to use vertiports built on top of garages (Head, 2021c).
- Blade mobility acts as a booking service for charter helicopter/short-haul private jets with a focus on the Northeast corridor and West Coast and also supplies medical transportation services (Nanalyze, 2022). Blade has ordered 20 Alia eVTOL vehicles from Beta (Head, 2021b) and has facilitated the purchase of these vehicles for other flight partners. From initial news releases/articles it seems that Blade will aim to integrate eVTOL vehicles into current services and adapt current infrastructure.

In summary, details of four near-term “realistic” UAM implementations are described above. These implementations range from entirely new services to services that introduce an eVTOL component to existing services. In terms of the infrastructure required to make the services accessible, there is a mix of new development (e.g., the Lilium vertiport) and utilization or adapting existing infrastructure. UAM infrastructure needs will only be finalized once certification requirements are completed and initial UAM implementations come to market. Thus, it may take until after these initial implementations to fully understand how much new infrastructure will be required by UAM services.

#### 2.2.7.3.4 Cost

The ultimate market potential for UAM is strongly dependent on cost considerations. There are several studies that give estimated costs for UAM travel. These studies are listed below.

- The BAH\_NASA study provided a detailed set of cost per mile estimates for UAM compared to other modes of transportation. Cost estimates per mile range from \$11 for a two person UAM vehicle to \$6.25 for a five person UAM vehicle (also noting Uber’s target of \$5.75 for a five person UAM). These costs compare with \$9.00 USD for a helicopter, \$11.75 for a limo, \$4 for luxury/high end ride share, and \$1.50 for a taxi.
- The KPMG study did not give specific cost estimates, but noted a target price per mile of \$3-\$5 if eVTOL UAM is to be competitive in the luxury rideshare market.
- Garrow, Roy, & Newman (2020) examined cost considerations from a consumer perspective using a consumer survey and multinomial logit choice model and calculated Value of Time (VOT) parameters for different models of commuter travel. These were

\$12.96/hr. for transit, \$15.14/hr. for automated vehicles, \$17.24/hr. for auto, and \$25.41/hr. for air taxi/eVTOL.

- Rimjha et al. (2021) created a feasibility and logit-choice model for UAM consumer demand in Northern California. Using the results of the model and assuming 75 vertiports in the region, metro demand was estimated using a sensitivity analysis for prices ranging from \$1 per mile (45,000 passengers per day) to \$3 per mile (<5,000 passengers per day). The authors noted a large drop-off in demand as prices rise above \$1, with demand at \$1.20 reduced by 35 percent. The authors gave a detailed analysis of feasibility for high price-low demand (\$1.80 per mile and 75 vertiports) and low price-high demand (\$1.20 per mile and 200 vertiports).
- A similar trade-off study was carried out by Mayakonda et al. (2020), who examined US demand for 15 US cities across a two-way table of UAM ticket cost (\$0.30 - \$7.20) and vertiport density. For the median value of vertiport density, the estimated potential UAM share of the transit market was 8.5 percent for a \$0.30 per mile cost and 0.002 percent for a \$7.20 cost per mile. The market share broke through 1 percent (1.2 percent) for a \$0.30 per mile cost and through 0.1 percent (0.127 percent) for a \$2.40 per mile cost.

A range of cost and pricing studies are listed above. The BAH\_NASA study is the most comprehensive of those listed and the costs generated by this study have been utilized in subsequent research. This research gave a cost per mile between \$6 and \$11 depending on the size of the UAM vehicle. These values may decrease with economies of scale. As per some of the other studies, lower cost values may be needed if UAM is to expand beyond a high-end niche. For example, the KPMG study assumes values of \$3-\$5 for UAM to be competitive in the high-end rideshare market segment. The price/revenue trade-off simulations given in Rimjha et al. (2021) and Mayakonda et al. (2020) both assume lower cost per mile values of less than \$3 to break into the mass transit market. The change in cost as UAM is implemented commercially and economies of scale takeoff could determine the eventual positioning of UAM in the overall transit market.

#### *2.2.7.3.5 User Acceptance*

There have been several studies that include surveys on user acceptance of UAM. These are detailed below.

- The BAH\_NASA study asked a series of questions on UAM acceptance to a panel of US consumers. A major question was “are you willing to travel in an Urban Air Mobility aircraft”, with five Likert scale responses from strongly agree to strongly disagree. Overall, around 60 percent of consumers answered with “strongly agree or agree to this question”. The authors found that younger age groups, males, and people who had previously been exposed to UAM had higher levels of user acceptance. There were also higher preferences for piloted over fully autonomous flights and travelling with friends.
- A user acceptance study by McKinsey (Kloss & Riedel, 2021) found that in the US, willingness to adopt UAM was 14 percent for commuting, 14 percent for running errands, 26 percent for business, 12 percent for short distance leisure travel, and 18 percent for airport travel.
- An airbus and air traffic management study (Yedavalli & Mooberry, 2019; subsequently referred to as “Airbus\_ATM” in this document) ran a consumer perceptions survey in four countries. The survey both measured perceptions of concern for safety and noise for certain

UAM scenarios and for general willingness to adopt UAM. A five-point Likert scale ranging from very unlikely to very likely was used to indicate willingness to adopt. In the US, 23 percent of respondents were very likely to adopt and 18 percent were likely to support UAM as a mode of transportation. Across all countries, there was higher adoption for younger people, males, urban dwellers, higher levels of education, people with longer commutes, and people who already rely on ridesharing.

Overall, there are some large commonalities across all three studies. Younger, more educated males, with longer commutes were more likely to adopt. Initial customer targeting effects may be aimed at segments with some or all of these characteristics.

Safety and noise issues were examined in the Airbus\_ATM study. Around 40 to 50 percent of respondents showed high levels of concern about these issues. It may be possible to mitigate these concerns with targeted promotion and advertising to improve perceptions (e.g., MacInnis & Jaworski, 1989), particularly given that most consumers do not have well-formed opinions on UAM, though actual operational characteristics (e.g., noise) and potential safety instances will strongly impact opinion.

#### **2.2.7.4 Regional Air Mobility**

RAM refers to the segment of travel within a region, but not within a city. Examples of RAM include business trips between cities within a region (for example, Orlando and Tampa) and regional leisure trips. While much of the initial emphasis of UAM implementations is on within metro applications, such as air taxi/commuter travel, several sources cited in the market analysis show the potential size for RAM markets to be viable in densely populated areas, even after all constraints are applied, as documented in the BAH\_NASA study (Booz Allen Hamilton, 2018; Goyal et al., 2021; Reiche et al., 2018). A report by NASA (2021b), noted that if operating costs could be reduced from more efficient electric propulsion methods and from automatization of pilot function then this could expand the RAM market and make it more feasible for a wider range of customer segments.

##### *2.2.7.4.1 Identifiable*

As per the BAH\_NASA body of work, RAM can be thought to encapsulate trips ranging from 50 miles to 500 miles, with UAM covering trips less than 50 miles. This gives a wide range of performance attributes. The NIAR VTOL database was analyzed to see how current and planned VTOL vehicles match this specification. In Figure 2.10, box plots<sup>7</sup> of the vehicle ranges were plotted by the maturity level (preliminary design, prototype build, subscale flight test, and ongoing certification). All vehicles undergoing current flight testing have a range of less than 250 miles, so only cover the lower end of the 50-to-500-mile range for RAM. However, going forward to vehicles in the prototype build and preliminary design stages, there are more longer-range vehicles, with the 75<sup>th</sup> range percentile for vehicles in the preliminary design stage reaching 500 miles. Thus, vehicles are planned that can cover the entire range of regional air mobility.

The market for RAM is expected to be part of the general market for regional travel, including regional jets, private jets, and regional helicopter services. However, there is very little overlap with the regional jet market. The FAA Aerospace Forecast 2021–2041 (FAA, 2022b) noted that

---

<sup>7</sup> The center of a box denotes the median, the bottom of the box the 25<sup>th</sup> percentile, the top of the box the 75<sup>th</sup> percentile, and the top/bottom lines the lowest/highest values excluding plotted outliers.



while the regional jet market is a substantial market, with 86 million domestic enplanements in 2020 (down from a pre-covid 159 million in 2019), the market is moving from 50 seat planes to larger, more fuel efficient, 70-90 seat planes. The FAA Aerospace Forecast predicted that the average number of seats will rise from 61 (in the 2010-2021 period) to 68 over the next two decades. Summary box plots of maximum passenger capacities for different maturity levels are given in Figure 2.11. In all stages of the vehicle maturity process, the 75<sup>th</sup> percentile of maximum passenger capacity is 4 passengers, with a maximum proposed size of 10 passengers. This indicates that RAM vehicles will be competing with private jet and helicopter services.

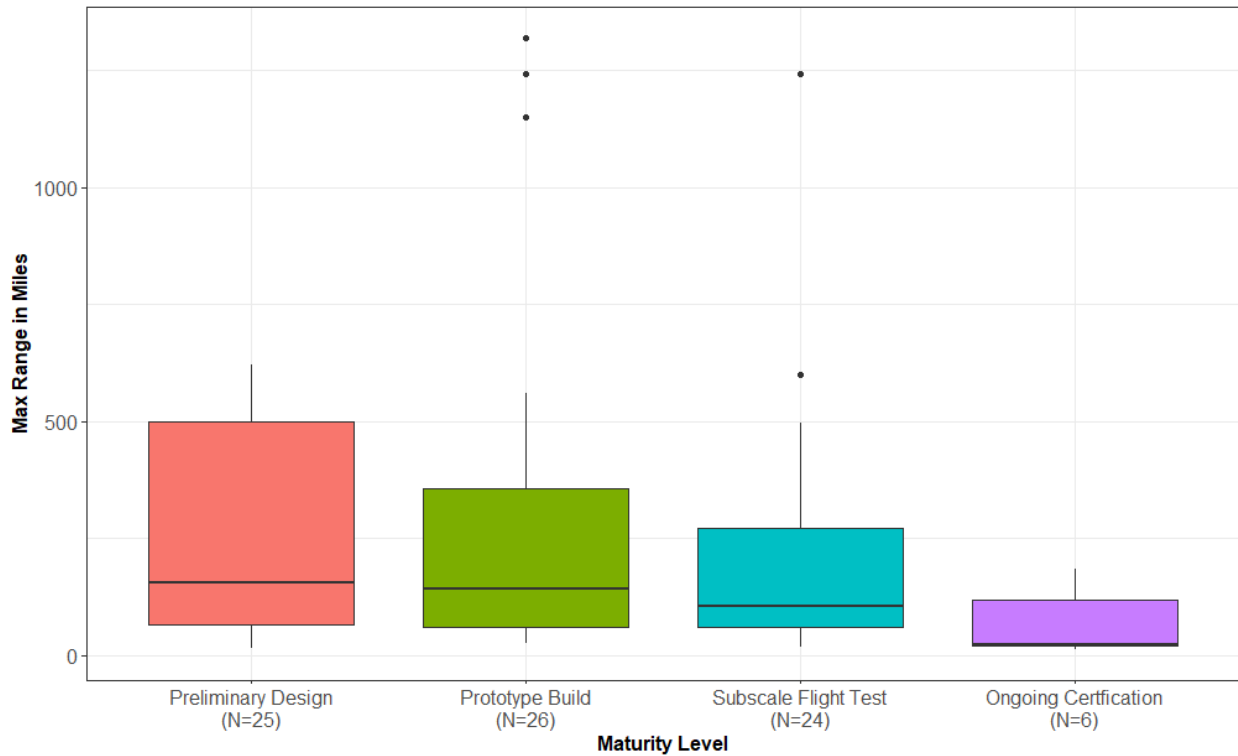

Figure 2.10. Maximum Range in Miles by Maturity.

Starry and Bernstein (2008) summarized the different classes of private jets ranging from “light,” with a maximum range of 1,114-2,200 miles and 7-11 passengers, to “long-range,” with a range of 4,469-6,305 miles and 17-19 passengers. In addition, the FAA Aerospace Forecast 2021–2041 (FAA, 2022b, p131) lists the average regional domestic trip as 489 miles in 2020, which is at the high-end of current RAM specifications.

Given the aforementioned vehicle specifications, eVTOL aircraft will be competing with light/medium jets in the regional flight market. Current regional helicopter travel, being of small capacity and with VTOL vehicles is probably the closest match to eVTOL travel.

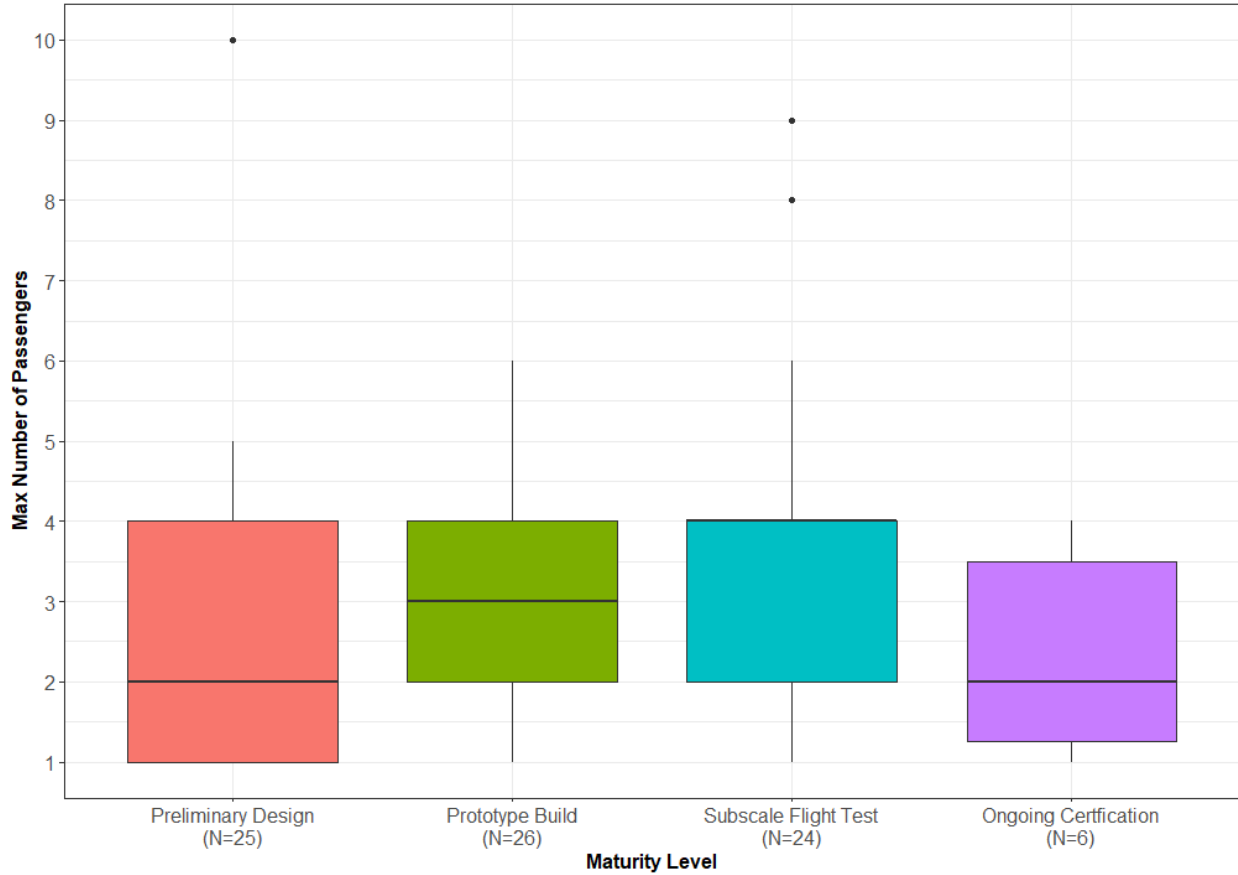

Figure 2.11. Maximum Number of Passengers in Miles by Maturity.

Another potential performance characteristic for UAM vehicles is the speed of vehicle. Summary box plots of maximum passenger capacities for different maturity levels are given in Figure 2.12. Here, all the top speeds for the more advanced maturity stages (subscale flight test, ongoing certification, and certified) are less than 200 mph. However, there are higher speed vehicles planned in the prototype build and preliminary design stages. Here, top speeds are up to 500 mph; however, the majority of speeds are still less than 200 mph. This puts the performance characteristics in a similar range to helicopters rather than small jets. For example, the average helicopter maximum speed is approximately 160 mph (Gatto, 2011) and a widely used modern mid-sized helicopter, the Airbus H160, has a top speed of 202 mph (Military Factory, 2021), while a characteristic small private jet, the Lear 45, has a top speed of 533 mph (Taylor, 1999).

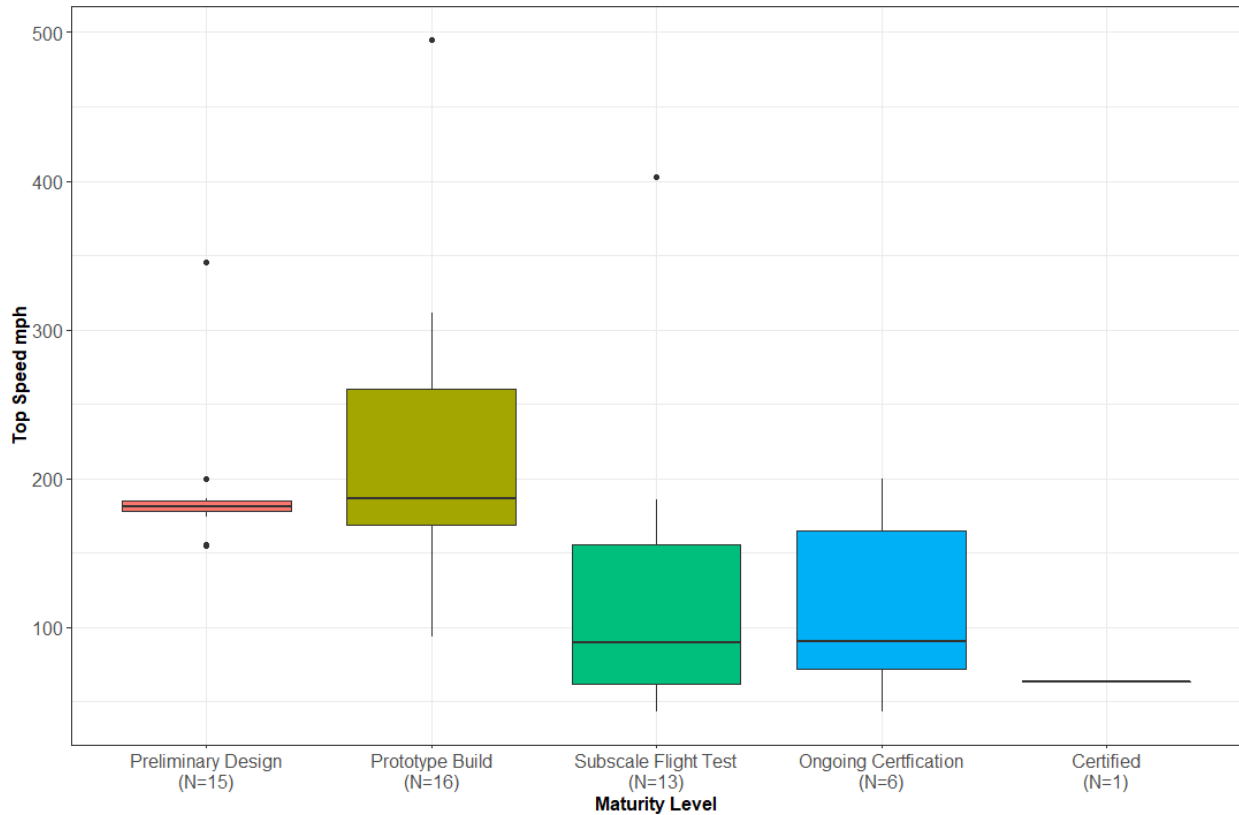

Figure 2.12. Top Speed in Miles per Hour by Maturity.

To further explore the characteristics of vehicles suitable for RAM, a visual scatterplot was created of vehicles suitable for RAM. To be included in the analysis vehicles needed to have a minimum maximum range of 50 miles (i.e., the lower bound of RAM), a minimum maximum speed of 150 mph (below the average helicopter maximum speed of 160mph) and a passenger capacity of at least four. Twelve aircraft satisfied the criteria and the top speed in mph was plotted against the maximum range in miles for each of these aircraft. The name labels were colored by maturity level. The resulting visualization is given in Figure 2.13. Visually, one can make out three specific clusters. The first consists of “borderline” RAM aircraft, which have speeds similar to helicopters and can cover the “lower end” of RAM journeys, up to approximately 200 miles. There is an “intermediate” segment of the prototype “Horizon Aircraft Cavorite X5” and “ASX MOBi-ONE V1”, which have operational characteristics between helicopters and regional jets (top speed in mph and max range in miles both around 300), and finally a single item segment, consisting of the “Pegasus Universal Aerospace Vertical Business Jet”, which has performance characteristics similar to current private jets (top speed 495 mph and range of 1,320 miles). If this vehicle and similar come to market then RAM with eVTOL vehicles can compete in the segment currently served by private jets.

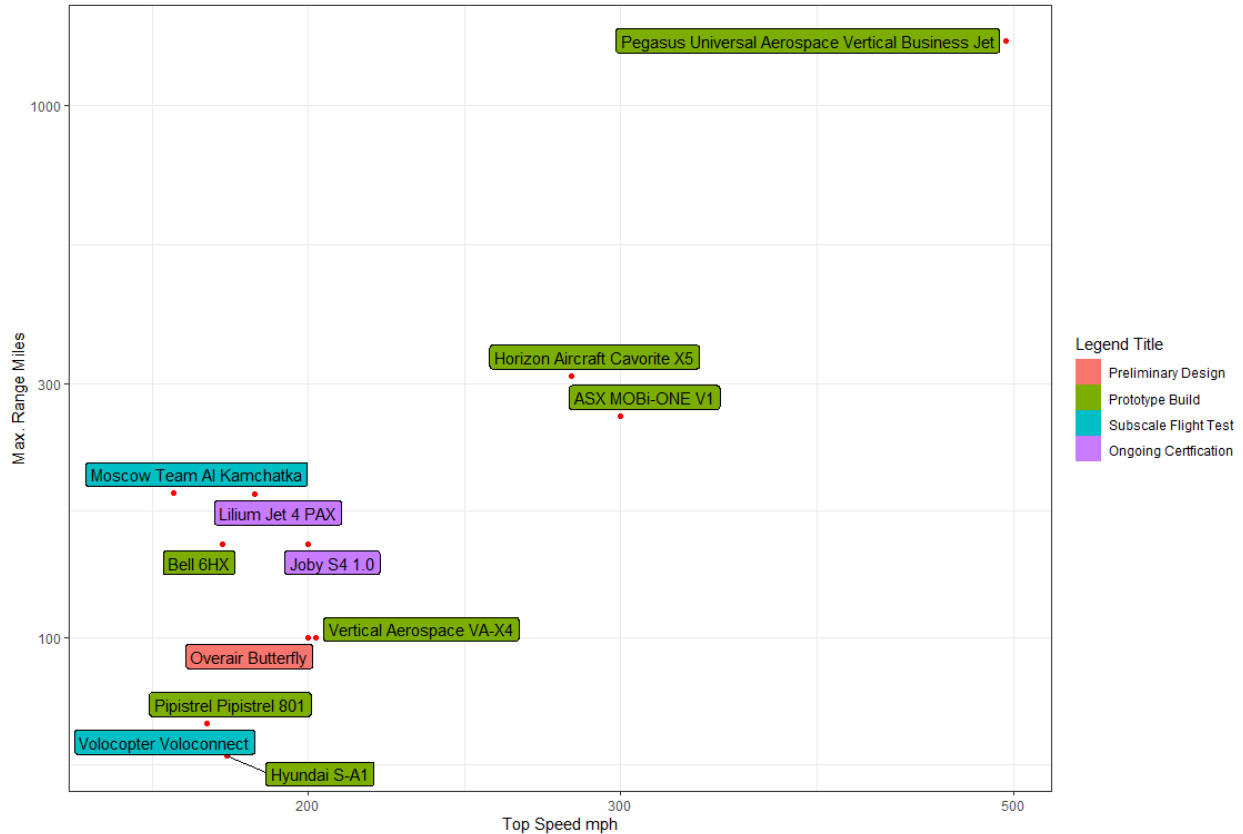

Figure 2.13. Visual Segmentation of Vehicles with RAM Characteristics.

Overall, there is a strong concordance between the market for RAM and the existing commercial helicopter market, though potential improvements in vehicle specifications and new usage scenarios could allow for RAM to develop new markets and to move into areas covered by the private jet market.

#### 2.2.7.4.2 Sizeable

As noted in the previous section, there is strong overlap between the RAM market and the commercial helicopter market, as well as some overlap with the private/business jet market. Given the lower capacities and speed of the eVTOL vehicles, there is little overlap between the eVTOL RAM market and the regional commercial jet market. Several sources are given below, but given the small-scale private ownership for these segments, accurate estimates of market size are difficult.

- A 2022 survey of the private jet market (Deane, 2022) estimated an overall market size for private and jet charter aircraft of \$24.4 billion in 2019, dropping to \$23.1 billion in 2020, but rising post-pandemic in 2021.
- The FAA Part 135 certification covers small private planes and helicopters. Usage statistics are available from the FAA (FAA, 2022b). For private aircraft with paid pilots there were 2,362,000 hours of flying time in 2019 and 1,617,000 hours of flying time in 2020. Similarly, there were 2,765,000 hours of flying time for air taxis in 2019 and

2,356,000 hours of flying time in 2020. Both of these markets include non-RAM segments (e.g., shorter distance flights for air taxis and non-passenger applications for the private aircraft figures, but they provide useful upper limits on demand), so should be considered constrained upper bounds for demand. The most recent available data is from 2020, but given the fast recovery from the pandemic in 2021 shown in other data sources, a similar bounce-back would be likely in these figures.

- WINGX (2022a) is a service that collates private business aviation market information. As of April 2022, over the last 30 days there have been 355,647 private flights in the US (11,854 per day), shared between propeller (32%), small jet (31%), medium jet (23%), and large jet (14%) flights. A graph of global private air traffic over the last few years (WINGX, 2022b), shows a drop in flights during the COVID pandemic, but strong recovery post-pandemic, to levels approximately 20 percent higher than pre-pandemic levels.
- The FAA Aerospace Forecast 2021–2041 (FAA, 2022b) shows 86 million domestic enplanements for regional jets in 2020 (down from a pre-covid 159 million in 2019). This volume is expected to recover strongly through 2021 and 2022. As noted previously, this market is unlikely to intersect significantly with the eVTOL market.

The overall current market amenable to RAM with eVTOL jets is difficult to forecast and calculate as it overlaps several different markets, including, but not limited to short-haul corridor air traffic and regional Amtrak rail service. The commercial regional jet market is the closest market to RAM in terms of distances travelled, but the current low capacity of eVTOL jets makes penetration into this market unlikely in the near future. The market served by business jets and helicopters is much more amenable to penetration by eVTOL vehicles, due to a larger overlap of vehicle sizes and other operational characteristics. These segments have seen strong market recovery since the pandemic.

It is possible to use some of the figures above in approximate back-of-the-envelope calculations (e.g., Purcell, 1985) and scenario analysis (e.g., Huss, 1988; Postma & Liebl, 2005). Consider a scenario  $x$  with private aircraft flights of roughly 10,000 a day,  $y$ -percent of these flights devoted to RAM, with an average RAM distance of  $z$  miles, and based on the costing analysis described in the UAM section of this report and taken from the BAH\_NASA analysis a price per mile of \$6.25 for a five person UAM. The flights per day number is fixed at 10,000, which is a rough estimate of the WINGX (2022a) number. Scenarios are given in a two-way table for different proportions of the overall private jet market being dedicated to UAM and the average trips per miles (i.e., are most trips closer to the 50-mile boundary or 500-mile boundary?).

The spreadsheet is shown in Figure 2.14. The median revenue scenario generates a yearly revenue of \$13.97 billion. This has good face validity. The Deane (2022) consulting numbers the medium revenue scenario (\$14 billion/\$25 billion = 56 percent) approximately match the proportion of the private jet market devoted to RAM. Within the two-way table, it is relatively easy to alter the variables. For example, given specific market estimates, it could be estimated that RAM has 50 percent of the overall market, and the “Proportion of RAM” dimension could be replaced by a “Flights per day” dimension with a range of numbers.

	A	B	C	D	E	F	G	H	I	J
1	Flights per day	Proportion RAM	Average Miles	Passengers	Cost Per Mile					
2	10000	0.5	200	5	6.25					
3										
4	Overall Revenue									
5	11,406,250,000									
6										
7										
8						Average Miles				
9			100	150	200	250	300	350	400	450
10		0.1	1.14	1.71	2.28	2.85	3.42	3.99	4.56	5.13
11		0.2	2.28	3.42	4.56	5.70	6.84	7.98	9.13	10.27
12		0.3	3.42	5.13	6.84	8.55	10.27	11.98	13.69	15.40
13	Proportion	0.4	4.56	6.84	9.13	11.41	13.69	15.97	18.25	20.53
14	RAM	0.5	5.70	8.55	11.41	14.26	17.11	19.96	22.81	25.66
15		0.6	6.84	10.27	13.69	17.11	20.53	23.95	27.38	30.80
16		0.7	7.98	11.98	15.97	19.96	23.95	27.95	31.94	35.93
17		0.8	9.13	13.69	18.25	22.81	27.38	31.94	36.50	41.06
18		0.9	10.27	15.40	20.53	25.66	30.80	35.93	41.06	46.20
19		1	11.41	17.11	22.81	28.52	34.22	39.92	45.63	51.33

Figure 2.14. Scenario Analysis with Revenue in Billions for RAM.

#### 2.2.7.4.3 Accessible/Actionable

Most of the initial commercial eVTOL implementations are designed for UAM implementations. As a pre-condition for RAM air mobility there must be infrastructure available in multiple regional areas/cities before RAM can take off. This is the view posited by the KPMG study on air mobility (Mayor and Anderson, 2020). Here they posit that the focus on initial eVTOL implementations will be on within-city UAM implementations from 2030-2050, but that by 2050, there may be some scope for RAM travel, with RAM travel up to 120 miles expected by 2050. However, this estimate may be overly conservative, as some providers, e.g. Lilium (Alcock, 2020), are aiming to introduce regional services relatively shortly after initial UAM commercial deployment. As per Figure 2.10 and Figure 2.12, given an increasing number of vehicles with longer range and the potential to fly at higher speeds, there may be scope for faster growth in RAM services.

#### 2.2.7.4.4 Cost

The cost per mile estimates given in the UAM section are general and could be adapted to the longer RAM journeys. There may be specific influences for longer journeys (e.g., lower relative fixed costs, but higher costs needed for larger batteries), but the per-mile estimates described in the UAM section can be used for base estimates.

#### 2.2.7.4.5 User Acceptance

The surveys outlined in the UAM section are mostly general in nature and do not differentiate based on the difference. There are some slight indicators of advanced passenger mobility adoption. For the McKinsey study (Kloss & Riedel, 2021), willingness to adopt for long distance leisure purposes is 10 percent, which is lower than willingness to adopt for UAM applications. One potential reason for this is that as noted by the BAH\_NASA study, people with previous exposure to air mobility display higher willingness to adopt, and most news exposure to AAM is on the topic of UAM/air taxi applications.

In addition, the choice set for regional travel is a little different in that competitors include helicopter travel and private jet travel, which have some commonality in safety perceptions with UAM, due to all of these modes being air travel modes.

### **2.2.7.5 Ambulance/Air Ambulance**

Together, ambulances and air ambulances form part of an overall emergency management infrastructure in the US. Ambulances provide local emergency response, while air ambulances are particularly useful in situations where high speed service is needed and where road/transportation difficulties can make ambulance service difficult, for example rural areas with poor road conditions and long distances to trauma centers (e.g. Nicholl et al., 1994), or congested urban areas (Eckstein et al., 2002), and in situations where severe trauma makes speed an important factor. For example, Larson et al. (2004), noted how air ambulance services could improve outcomes in pediatric trauma cases and Rhinehart et al. (2013) noted that mortality rates were lower for people who were close to air ambulance infrastructure.

There has been much recent interest in incorporating eVTOL vehicles into the air ambulance infrastructure. For example, Reichmann (2021), citing a study by “German air rescue service ADAC Luftrettung” noted that using eVTOL ambulances could potentially reduce service time and cost. This article also notes efforts from American company Jump Aero to develop eVTOL to decrease emergency response time and posits that eVTOL Volocopter aircraft have a significant speed advantage over conventional emergency medical response, being able to reach emergencies twice as fast in rural areas compared to the conventional emergency medical service

There have been several initial commercial attempts to produce eVTOL based air ambulance services. For example, Cowan (2002) described the Urban Aeronautics’ CityHawk vehicle (an eVTOL air ambulance), which was created with the aim of reducing current response times and improved cardiac arrest outcomes.

#### *2.2.7.5.1 Identifiable*

Most initial work on eVTOL air ambulances assumes a similar set of vehicles to passenger UAM vehicles (e.g., the BAH\_NASA study, Reiche et al., 2018) and so the vehicle summary ranges are similar to those examined in the “Identifiable” section for UAM and RAM. For simplicity, this segment is defined as containing Emergency Medical Services (EMS) using either eVTOL vehicles or hybrid eVTOL vehicles. As with standard passenger applications, it is expected that initial services will be piloted, with the potential for some automation at a potential future date.

Of the initial proposals for eVTOL, the majority have been developed for short/medium-range travel with multiple passengers. For example, the proposed CityHawk EMS eVTOL (CityHawk EMS, 2002) has a listed range of 90 miles and the Orca Aerospace EMS eVTOL (Transport Up, 2021) has a range of 110-130 km (68-81 miles), with a top speed around 300 kilometers per hour (186.4 mph).

#### *2.2.7.5.2 Sizeable*

Air ambulance eVTOL solutions are posited as intermediate solutions to both the conventional ambulance market and the air ambulance market, there is potential to take potential market share from both markets. As per KBV Research (2021), the Global Air Ambulance services market is expected to be worth \$12.1 billion by 2027 with an average compound annual growth rate of 11.4 percent from 2021-2027. In an analysis of the overall market, precedence Research (2022) estimated the overall global value of ambulance services as US\$ 29.49 billion in 2021 with a forecast of 13.9 percent compound annual growth between 2021 and 2030, giving an estimated market size of US\$ 95.1 billion in 2030. A discussion in Cowan (2022) notes the potential for

eVTOL vehicles to take a market share of up to 5 percent of the overall market, which given projected 2030 numbers would be approximately \$4-5 million.

#### *2.2.7.5.3 Accessible/ Actionable*

The accessibility and actionability of the eVTOL air ambulance segment will depend on both commercial and regulatory issues. The BAH\_NASA study found that the air ambulance market could be potentially viable given the commercial deployment of hybrid VTOL aircraft, but expressed some skepticism on the possible use of eVTOL aircraft in the near future due to limitations with respect to battery weight and recharging times. Another possible limitation is the implementation of FAA certification standards that may be specific to the air ambulance market. However, a report detailing UAM potential in Ohio (Del Rosario et al., 2021) noted a range of factors to be dealt with before UAM can become feasible. These include providing medical infrastructure at UAM hubs, dealing with excess passenger weight, helipad accessibility, potential weather issues affecting availability, and EMS coverage/integration with the overall EMS ecosystem. The weather issues in this area are particularly pertinent for emergency travel, as what may be an inconvenience for commuter applications (e.g., Reiche et al., 2018) is possibly a major restrictive factor for EMS trauma applications.

#### *2.2.7.5.4 Cost*

The cost factors for eVTOL air ambulance vis-à-vis ground transportation and traditional air transportation are similar to those for UAM for short-haul journeys and RAM for longer journeys. However, there have been several attempts to price eVTOL air ambulance trips relative to traditional trips. The BAH analysis includes a simulation study (Reiche et al., 2018; Goyal & Cohen, 2022) of potential ground ambulance, air ambulance, and eVTOL vehicles. They found aggregate costs per trip of \$500 for ground ambulances, \$9,000 for battery/electric eVTOL ambulances, \$9,800 for hybrid eVTOL ambulances, and \$10,000 for traditional rotary-wing helicopters. Thus, it is likely that eVTOL ambulances will fill a similar niche to traditional rotary-wing helicopters in being more expensive than ground ambulances but offering faster transportation and improved survivability for trauma cases.

An additional factor in eVOTL air ambulance competitiveness is the billing structure of air ambulance flights. As noted in the discussion in section 2.5.4 and the previously cited Fuse-Brown et al. (2020) work, air ambulance bills are often out-of-network for health insurers and charges are 433 percent of the Medicare base rate. Approximately 52 percent of bills not fully covered by insurers, with an average balance to be paid by the patient of around \$20,000. These out-of-pocket charges and the associated controversy (e.g., Sison, 2019) may spur state and federal regulation, which may restrict the potential for air ambulance profitability.

In summary, the overall competitiveness of eVOTL aircraft will depend on maintaining a price advantage over traditional rotary wing helicopters, the regulatory environment at federal, state, and local levels, and the fee structure set by medical insurance providers and Medicare.

#### *2.2.7.5.5 User Acceptance*

User acceptance for eVTOL air ambulances will depend on many of the same factors as acceptance for advanced passenger mobility applications. In fact, an interview with an eVTOL provider in Cowan (2022) raised the point that integrating eVTOL vehicles into the emergency response infrastructure could help improve general trust and user acceptance of eVTOL vehicles for general applications. The Ohio UAM study (Del Rosario et al., 2021) gave a use case for air ambulances



and noted that air ambulances can be utilized for time-sensitive non-passenger applications, such as organ delivery. The utilization of eVTOL vehicles in such applications could help gain the trust necessary to utilize such vehicles in human passenger transportation applications.

#### **2.2.7.6 Macro Consumer Segmentation Summary**

Overall, this section has analyzed three major “macro” segments of the AAM market. These segments were analyzed using a general segmentation framework where the segments were analyzed using the general identifiable, sizeable, and accessible/actionable attributes, and also domain specific cost, user, and acceptance attributes. Of the three segments, the air ambulance segment was something of a standalone segment, while the UAM and RAM segments both are standard customer transportation segments but are defined primarily in terms of the length of the customer journey. The analysis focused on the potential for new and existing services (e.g., commuter helicopters, private jets), where existing vehicles are replaced by potentially more efficient and environmentally friendly eVTOL vehicles. While the UAM and RAM segments were treated separately, there is bound to be some integration in terms of in-metro and between metro travel, particularly at the boundary area between UAM and RAM (journeys between 50 and 100 miles).

The segmentation was taken at a low level of granularity, with the analysis of three “macro” segments. As more information becomes available on potential UAM implementations, it may be possible to carry out a more detailed segmentation analysis for specific usage situations (e.g., commuters, holiday travelers, etc.). The scope of such an analysis would need to be defined carefully and may be metro specific. For example, segments in more spread-out, lower-density metros, such as the Greater Los Angeles area, may be different from a denser metro, such as the New York City metro. Such analyses could use both behavioral and perceptual data. Behavioral segmentation (e.g., Bucklin et al., 1998) could be derived from actual travel data, for similar services or from a consumer panel where participants record travel behavior in a similar manner to how panel members record purchases for a Nielsen consumer panel (Einav et al., 2008). There have been several perceptual surveys of AAM travel, with some surveys focusing on user acceptance (Kloss & Riedel, 2021; Reiche et al., 2018; Yedavalli & Mooberry, 2019) and some focusing on the use of stated preference surveys to estimate consumer demand (e.g., Garrow, Roy, & Newman, 2020).

The market segmentation section ties into the subsequent demand analysis in several ways. First, the analysis collated and synthesized multiple data sources to examine and give context to market demand estimates for multiple areas of AAM (including UAM, RAM, and air ambulance services). The demand estimate section follows this by examining and estimating demand scenarios for focused metro area UAM demand, which given previous studies and upcoming implementations is the “macro-segment” with the most overall visibility. Second, several back of the envelope calculations are given for RAM demand. These calculations give further context to any demand calculations. Third, in the demand calculation section, Bass modeling is used to help construct low, medium, and high demand scenarios for UAM. The information given in this section can help put these estimates into context, enable decision makers to understand the likelihood of these different scenarios, and intelligently choose modeling parameters.

## 2.3 Estimating Demand 2022 – 2045

### 2.3.1 Target Markets and Suitable Market Conditions

Currently, more than 200 companies worldwide are developing transformative eVTOL aircraft, with more than a dozen projects receiving significant private investment (eVTOL, 2019). Though UAM passenger operations have yet to launch in the US, OEMs are actively working to enhance their aircraft technologies, obtain certification, and prepare for full-scale manufacturing. According to SMG Consulting (2021) five companies are targeting operations in the US from 2024-2026, as shown in Table 2.10.

Table 2.10. AAM Passenger Launch Cities (SMG Consulting, 2021).

Launch City	Original Equipment Manufacturer
Orlando, FL	Lilium (2024)
New York City, NY	Blade (2024), Halo (2026)
Los Angeles, CA	Archer (2024)
Marina / Santa Cruz, CA	Joby (no launch date identified)
Miami, FL	Archer (2024)

On the West Coast, Joby and Archer Aviation are preparing to begin operations. Joby has received \$1.8 billion in funding and has established its headquarters in Santa Cruz, California (SMG Consulting, 2021), while Archer is expected to begin operations in Los Angeles in 2024 and has received \$856.3 million in funding (SMG Consulting, 2021). On the other side of the country, Blade and Halo are anticipated to begin operations in New York City in 2024 and 2026, respectively, while Archer is aiming to commence operations in Miami in 2024 (SMG Consulting, 2021). Lilium is targeting 2024 as a launch year for its operations at the Lake Nona Aerotropolis in Orlando.

In conjunction with operator-led launch sites, it is anticipated that public investment will generate new markets. Sponsored by NASA, a cohort of five community annex teams will receive public investment to advance AAM activities within their respective areas (NASA, 2021a). Annex teams include the Massachusetts Department of Transportation, the Minnesota Department of Transportation, the North Central Texas Council of Governments, the Ohio Department of Transportation, and the City of Orlando (NASA, 2021a). A map of launch cities, community annex teams, and OEM headquarter locations can be found in Figure 2.15.

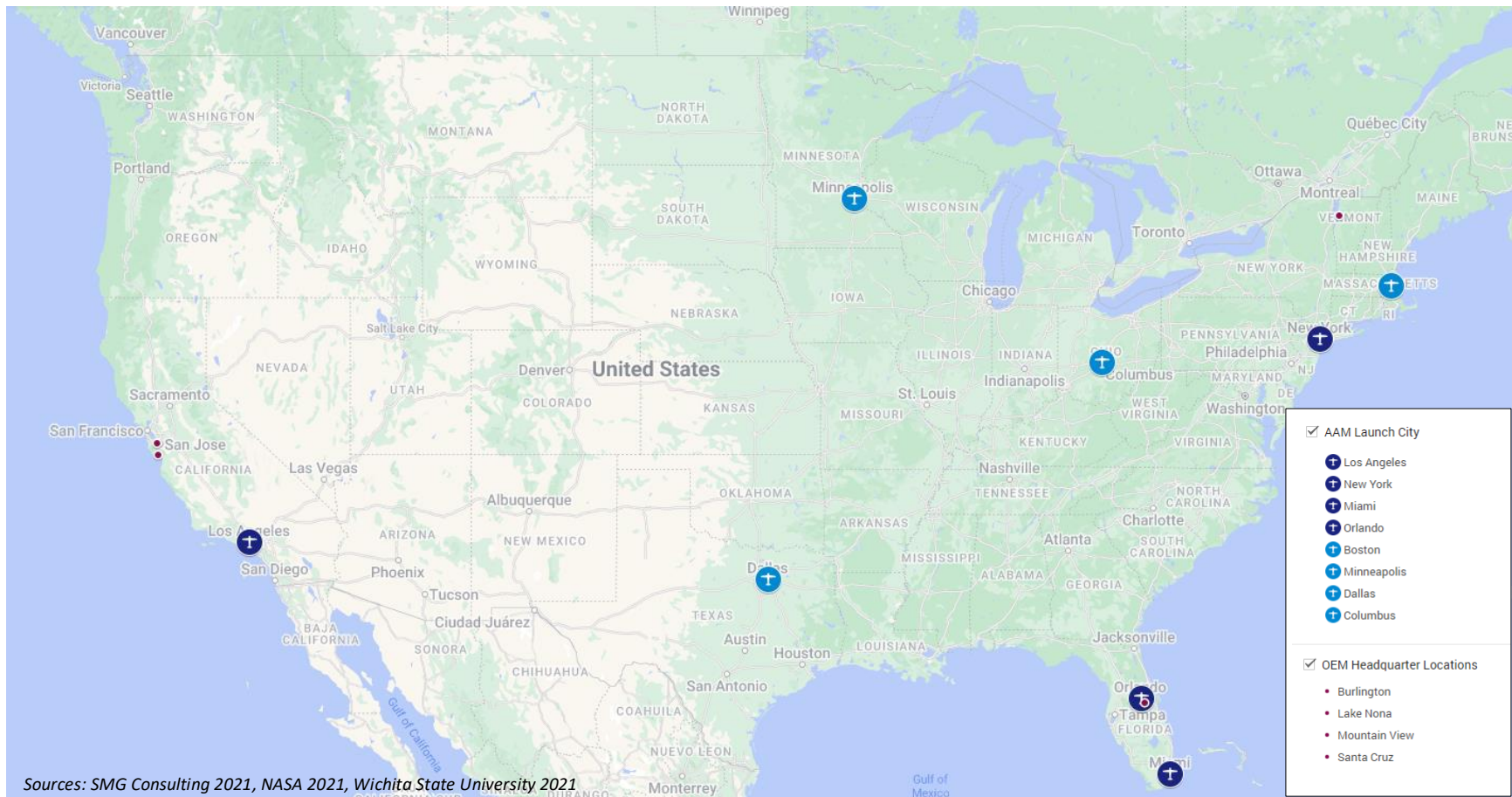

Figure 2.15. UAM Passenger Market Launch Sites and Operator Headquarters.

As UAM takes off in the US, several characteristics may elevate passenger growth within specific domestic markets. Research indicates that an important first step in UAM development will involve targeting a narrow, but potentially lucrative market segment of people who are willing to pay premium fares to avoid commuter stress, congestion, and travel time (Mayor and Anderson, 2019; Haan et al., 2020). Thus, regions with highly gridlocked surface transportation systems and high-income earners make an opportune pairing for UAM passenger services. It is anticipated that the increase of urbanization and reliance on automobiles in metropolitan areas in the US will continue to facilitate UAM growth for the foreseeable future (Yedavalli and Mooberry, 2019). Regions that are restricted by geography in their ability to develop cost-effective new infrastructure for relieving automobile congestion will be particularly suitable sites for UAM market growth (CAM, 2020a).

In addition to congestion and income, there are a number of other variables that influence UAM growth and development. For example, regions that have a high concentration of airports and business travelers are likely to be more successful as UAM and RAM markets, as they can connect passengers who are willing to pay for expedited travel from an airport to a meeting, conference, or other business engagements (Booz Allen Hamilton, 2018). As such, the existence of airports and the composition of airport passengers would likely influence the suitability of an advanced air mobility marketplace.

To fully understand the most suitable locations for UAM passenger services within the US, the research team reviewed more than 100 peer-reviewed journal articles, market reports, industry papers, and regulatory briefings. The literature review led to the determination of 13 variables that affect UAM passenger market growth, as shown in Table 2.11.

Table 2.11. Site Suitability Analysis Variables for Advanced Passenger Mobility Markets.

Category	Variable	Variable Description	Variable Reference
Urban Structure	Population Density	The more people there are within a specified area, the greater likelihood that AAM passenger services will be able to connect target customers with their desired business or leisure destinations.	KPMG 2019, Georgia Tech 2020, Joby 2021, Booz Allen Hamilton
	Polycentrism	Polycentrism is a measure of fully-formed city centers within a region. The more city centers there are within a specified area, the greater likelihood that AAM services will be needed in the region.	NCSU and MSU 2021 (Based on Lilium’s advertised markets)
Economic Scale	Fortune 1,000 Presence	The presence of Fortune 1,000 companies within a region catalyzes the need for CEO or executive leadership travel, which is somewhat price inelastic, and a target market for AAM service providers.	UAM Geomatics 2021, Joby 2021
	Gross Regional Product (GRP)	The higher and area’s GRP, the greater the likelihood that there will be a lot of business activity in the region. This may allow AAM services to capture or address business travelers’ needs.	KPMG 2019, UAM Geomatics 2021, Joby 2021
Congestion and Travel Time	Average Time to Work	The longer an individual’s commute time to work, the greater the potential for an AAM trip to save time for that individual, relative to their existing travel method.	KPMG 2019, UAM Geomatics 2021, Joby 2021, Booz Allen Hamilton, 2018
	Travel Time Index	A travel time index is a measure of average travel conditions that demonstrates how much longer, on average, travel times are during congestion compared to light traffic. The higher the travel time	KPMG 2021, UAM Geomatics 2021, Joby 2021, Booz

Category	Variable	Variable Description	Variable Reference
Congestion and Travel Time		index, the greater the likelihood for AAM services to be competitive in the region.	Allen Hamilton 2021
	Airport to Central Business District Drive Time	Trips that connect city centers to airports will be a fundamental market segment for AAM. This segment, referred to as the airport shuttle, will be most competitive with vehicular modes of transport when longer drive times from the airport to a region's central business district exist.	Booz Allen Hamilton 2018
	Heliports Per Capita	The greater the number of heliports or airports per capita, the more opportunities for existing infrastructure to support AAM services.	UAM Geomatics 2021, Joby 2021, Booz Allen Hamilton 2018
Airports per Capita			
Market Readiness	Class B Airspace	Presence (or not) of Class B Airspace in MSA (binary). The presence of Class B airspace in a region indicates congestion and creates ATC clearance requirements for AAM services that limit operating locations. Such requirements may be particularly encumbering for airport shuttle and RAM contexts.	FAA Input 2021
	Class G Airspace Congestion	AAM services are anticipated to primarily occupy Class G airspace. If this airspace is highly congested within a region, it will limit the number of AAM trips that can be undertaken.	FAA Input 2021
Market Readiness	Existing Investment	Public or private sector investment in AAM infrastructure and policies can catalyze AAM activities. The greater the investment, the more likely AAM services are to take hold in a region.	FAA Input 2021
Existing Short-Haul Market	Airport Short-Haul Market Stability (<150 miles)	Short-haul airport trips carrying passengers less than 150 miles demonstrate markets that are conducive to air travel and are within the maximum range of AAM passenger service. These markets offer growth opportunities for AAM passenger trips.	UAM Geomatics 2021, Joby 2021, Booz Allen Hamilton 2018

Source: ASSURE Research Project A36 | North Carolina State University and Mississippi State University, 2022

These variables can be grouped into categories of urban structure, economic scale, congestion and travel time, market readiness, and existing short-haul demand characteristics. Using these variables, a site suitability analysis was undertaken to derive where the most opportune market locations for AAM passenger services are within the US.

### 2.3.1.1 Market Conditions Data & Methods

The variables used to describe market conditions for advanced passenger mobility services were derived from a variety of existing sources and also included novel datasets created by the A36 research team. In some instances, datasets required preprocessing and joining to MSA geographies. All variables required scaling prior to weighting and final suitability calculations.

Eleven of the variables have a positive relationship with AAM market activities, meaning the greater the extent of their influence, the more favorable the AAM market for OEMs. These variables are considered AAM market drivers, and they include: population density, polycentrism, the presence of Fortune 1000 companies, gross regional product, average time to work, travel time index, the airport to central business district drive time, heliports per capita, airports per capita, existing public and private sector investment, and airport short-haul market stability. Within the 13 variables, there are two (2) variables that operate as AAM market barriers and their presence has a negative relationship with AAM market activities. These variables include: the presence of Class B airspace (regulated airspace by commercial airports) and the level of Class G airspace

congestion (unregulated airspace in which AAM missions are likely to occur). Variable data, sources, preprocessing, and standardization techniques are provided in Table 2.12.

Table 2.12. Data Details for Site Suitability Analysis Variables.

Variable	Data	Data Source	Preprocessing	Standardization
Population Density	Average population per square mile in MSA	U.S. Census Bureau (2019)	None required	Min-Max Continuous (1 = highest density)
Polycentrism	Count of distinct employment centers in MSA	Arribas-Bel and Sanz-Gracia (2014)	None required	Min-Max Continuous (1 = most centers)
Fortune 1000 Presence	Count of Fortune 1000 company headquarters in MSA	Fortune (2021)	Spatially join headquarters points to MSA features	Min-Max Continuous (1= most headquarters)
GRP per Capita	Gross domestic product of MSA per capita	BEA (2019)	None required	Min-Max Continuous (1= highest GDP/cap)
Average Time to Work	Average one-way commute time (minutes) per capita	U.S. Census Bureau (2019)	None required	Min-Max Continuous (1= most time)
Travel Time Index	Index of peak period travel time to free-flow conditions in MSA	Schrank et al. (2021)	Spatially join Urban Area features to MSA features	Min-Max Continuous (1= highest Index)
Airport to CBD Drive Time	Estimated driving time in free-flow conditions from commercial airports to Central Business District (CBD)	Google (n.d.), FAA (2019)	Drive time in free-flow conditions is estimated using Google Maps. For MSAs served by multiple commercial airports, values reflect a weighted average driving time weighted by percentage of commercial aircraft operations at each airport	Min-Max Continuous (1- most time)
Heliports per Capita	Count of heliports per capita in MSA	BTS (2020)	Heliport facility points joined to MSA, per capita value calculated from total MSA population (U.S. Census ACS 2019 5-year Estimate)	Min-Max Continuous (1= Most Heliports per cap)
Airports per Capita	Count of airports per capita in MSA	BTS (2020)	Airport facility points joined to MSA, per capita value calculated from total MSA population (U.S. Census ACS 2019 5-year Estimate)	Min-Max Continuous (1= Most Airports per cap)
Class B Airspace	Presence (or not) of Class B Airspace in MSA (binary)	FAA (2021)	Intersect Class B airspace and MSA features to determine extent of coverage.	Binary (1= Class B Present, 0 = Not Present)
Class G Airspace Congestion	Average total aircraft operation hours per square mile in Class G airspace in MSA	FAA (2021)	Rasterize GLARE Class G hours in zip code data; use zonal statistics to calculate average total hours for MSA features	Reverse Min-Max Continuous (1= Fewest hours in Class G)

Variable	Data	Data Source	Preprocessing	Standardization
Public & Private Investment	UAM Launch City or Headquarters City locations	SMG Consulting (2021), NASA (2021), Wichita State University (2021)	Spatially join launch and headquarters points to MSA features	Discrete, Cumulative (1.0 for each Launch City, 0.5 for each UAM Headquarters)
Airport Short-Haul OD <150 Miles	Count (2019) of flight arrival and departure points within MSA for total flight distances of less than 150 miles	FAA (2021)	Using all flights to all airports (2019) with ASPM metrics calculate distance between O-D pairs and filter to select routes shorter than 150 miles. Convert Line segments converted to points (corresponding to arrival and departure location) and spatially join points to MSA features.	Min-Max Continuous (1= Most arrivals and departures)

**2.3.1.2 Suitability Analysis Results**

The research team used the Simple Multi-Attribute Rating Technique (SMART) to develop suitability scores for the 100 most-populous MSAs in the US. Using this approach, each MSA was given a final score using the weighted average of standardized market condition attributes. Weights assigned using the SMART model reflect the relative importance of each variable to the decision-maker. The research team calibrated variable weights by emphasizing market characteristics of UAM launch cities. The final set of variables and weights, referred to as the Base Scenario, is shown in Table 2.13.

The Base Scenario holds urban structure, readiness, and economic scale as the highest weighted categories. This scenario also balances factors reflecting market size and economic scale with operational constraints inherent to those contexts. The Base Scenario places significantly more emphasis on polycentric urban form (which indicates the quantity of distinct destinations within a metro area for air taxis) than existing short-haul flight demand. Additional scenario analyses that emphasize other variable categories are discussed in the following section and in the appendix. For each scenario, the research team used rank ordered centroid (ROC) weights, an approximation of factor weight based on factor importance rank, to guide weights applied to variable categories (Goodwin & Wright, 2003).

Table 2.13. Site Suitability Analysis Variable Weighting - Base Scenario.

Category	Category Weight Total	Variable	Variable Weight
Urban Structure	35.0	Population Density	15.0
		Polycentrism	20.0
Economic Scale	15.0	Fortune 1000 Presence	5.0
		GDP per Capita	10.0
Congestion	7.5	Average Time to Work	2.5
		Travel Time Index	2.5
		Airport to CBD Drive Time	2.5
Readiness	32.5	Heliports per Capita	5.0
		Airports per Capita	10.0

Category	Category Weight Total	Variable	Variable Weight
		Class B Airspace	2.5
		Class G Airspace Congestion	5.0
		Public & Private Investment	10.0
<b>Existing Demand</b>	10.0	Airport Short-Haul OD <150 Miles	10.0

Under the assumptions provided for the Base Scenario, the MSAs in the US that have the most suitable market conditions for AAM passenger market development are shown in Table 2.14.

Table 2.14. Most Suitable MSAs for AAM Passenger Services – Base Scenario (ASSURE A36, 2022).

Rank	Name	Score
1	New York-Newark-Jersey City, NY-NJ-PA Metro Area	74.13
2	Los Angeles-Long Beach-Anaheim, CA Metro Area	66.23
3	Dallas-Fort Worth-Arlington, TX Metro Area	39.27
4	Boston-Cambridge-Newton, MA-NH Metro Area	36.00
5	San Jose-Sunnyvale-Santa Clara, CA Metro Area	34.22
6	Orlando-Kissimmee-Sanford, FL Metro Area	33.92
7	Detroit-Warren-Dearborn, MI Metro Area	32.73
8	Miami-Fort Lauderdale-Pompano Beach, FL Metro Area	32.67
9	San Francisco-Oakland-Berkeley, CA Metro Area	31.81
10	Columbus, OH Metro Area	31.73
11	Minneapolis-St. Paul-Bloomington, MN-WI Metro Area	31.15
12	Chicago-Naperville-Elgin, IL-IN-WI Metro Area	30.73
13	Bridgeport-Stamford-Norwalk, CT Metro Area	28.41
14	Washington-Arlington-Alexandria, DC-VA-MD-WV Metro Area	28.29
15	Houston-The Woodlands-Sugar Land, TX Metro Area	27.83
16	Riverside-San Bernardino-Ontario, CA Metro Area	26.82
17	Philadelphia-Camden-Wilmington, PA-NJ-DE-MD Metro Area	25.16
18	Indianapolis-Carmel-Anderson, IN Metro Area	24.96
19	Seattle-Tacoma-Bellevue, WA Metro Area	24.82
20	Allentown-Bethlehem-Easton, PA-NJ Metro Area	24.45
21	Atlanta-Sandy Springs-Alpharetta, GA Metro Area	24.06
22	Madison, WI Metro Area	23.73
23	Providence-Warwick, RI-MA Metro Area	23.64
24	Poughkeepsie-Newburgh-Middletown, NY Metro Area	23.57
25	Hartford-East Hartford-Middletown, CT Metro Area	23.10
26	Pittsburgh, PA Metro Area	23.05
27	Wichita, KS Metro Area	22.81
28	Portland-Vancouver-Hillsboro, OR-WA Metro Area	22.73
29	Cleveland-Elyria, OH Metro Area	22.72
30	Milwaukee-Waukesha, WI Metro Area	22.43
31	Buffalo-Cheektowaga, NY Metro Area	22.29
32	Tampa-St. Petersburg-Clearwater, FL Metro Area	22.12
33	Austin-Round Rock-Georgetown, TX Metro Area	22.08
34	San Diego-Chula Vista-Carlsbad, CA Metro Area	22.07
35	Oxnard-Thousand Oaks-Ventura, CA Metro Area	21.45
36	Harrisburg-Carlisle, PA Metro Area	21.10
37	Baton Rouge, LA Metro Area	20.96
38	Denver-Aurora-Lakewood, CO Metro Area	20.90
39	Virginia Beach-Norfolk-Newport News, VA-NC Metro Area	20.87
40	New Orleans-Metairie, LA Metro Area	20.76
41	Toledo, OH Metro Area	20.72
42	Baltimore-Columbia-Towson, MD Metro Area	20.71



Rank	Name	Score
43	Albany-Schenectady-Troy, NY Metro Area	20.66
44	Urban Honolulu, HI Metro Area	20.57
45	Youngstown-Warren-Boardman, OH-PA Metro Area	20.39
46	Kansas City, MO-KS Metro Area	20.39
47	Oklahoma City, OK Metro Area	20.38
48	San Antonio-New Braunfels, TX Metro Area	20.35
49	New Haven-Milford, CT Metro Area	20.23
50	Phoenix-Mesa-Chandler, AZ Metro Area	20.19
51	Nashville-Davidson--Murfreesboro--Franklin, TN Metro Area	20.18
52	Dayton-Kettering, OH Metro Area	20.09
53	Raleigh-Cary, NC Metro Area	19.80
54	Sacramento-Roseville-Folsom, CA Metro Area	19.74
55	Omaha-Council Bluffs, NE-IA Metro Area	19.68
56	Tulsa, OK Metro Area	19.16
57	Charlotte-Concord-Gastonia, NC-SC Metro Area	19.09
58	Grand Rapids-Kentwood, MI Metro Area	19.03
59	Richmond, VA Metro Area	19.00
60	Jackson, MS Metro Area	18.56
61	Little Rock-North Little Rock-Conway, AR Metro Area	18.54
62	Rochester, NY Metro Area	18.50
63	Scranton--Wilkes-Barre, PA Metro Area	18.41
64	Stockton, CA Metro Area	18.36
65	Akron, OH Metro Area	18.27
66	Boise City, ID Metro Area	18.25
67	Cincinnati, OH-KY-IN Metro Area	17.90
68	Louisville/Jefferson County, KY-IN Metro Area	17.81
69	Birmingham-Hoover, AL Metro Area	17.59
70	Modesto, CA Metro Area	17.54
71	Worcester, MA-CT Metro Area	17.45
72	Cape Coral-Fort Myers, FL Metro Area	17.42
73	Lancaster, PA Metro Area	17.36
74	Des Moines-West Des Moines, IA Metro Area	17.24
75	Greensboro-High Point, NC Metro Area	17.22
76	Lakeland-Winter Haven, FL Metro Area	17.16
77	St. Louis, MO-IL Metro Area	17.14
78	Springfield, MA Metro Area	17.08
79	Greenville-Anderson, SC Metro Area	16.60
80	Syracuse, NY Metro Area	16.40
81	Chattanooga, TN-GA Metro Area	16.25
82	Knoxville, TN Metro Area	16.21
83	Colorado Springs, CO Metro Area	16.04
84	Augusta-Richmond County, GA-SC Metro Area	15.88
85	Fresno, CA Metro Area	15.81
86	Bakersfield, CA Metro Area	15.74
87	Jacksonville, FL Metro Area	15.67
88	Memphis, TN-MS-AR Metro Area	15.39
89	Charleston-North Charleston, SC Metro Area	15.31
90	Columbia, SC Metro Area	14.75
91	Palm Bay-Melbourne-Titusville, FL Metro Area	14.49
92	Las Vegas-Henderson-Paradise, NV Metro Area	14.41
93	El Paso, TX Metro Area	14.02
94	Tucson, AZ Metro Area	13.55
95	Salt Lake City, UT Metro Area	13.55
96	North Port-Sarasota-Bradenton, FL Metro Area	13.42
97	McAllen-Edinburg-Mission, TX Metro Area	13.28
98	Albuquerque, NM Metro Area	12.98

Rank	Name	Score
99	Provo-Orem, UT Metro Area	12.27
100	Ogden-Clearfield, UT Metro Area	10.66

*Source: North Carolina State University and Mississippi State University, 2022 | ASSURE Project A36*

The site suitability analysis is a first step to gauge where AAM passenger market development is most likely to occur in the US. Analysis results are mapped in Figure 2.16. Suitable locations are shown in blue color gradation with the darkest hues being most suitable for AAM development. Of the eight AAM launch cities identified in Section 3.1, seven are found in the top ten ranked metros in the Base Scenario, and the eighth, Minneapolis, is ranked eleventh in the Base Scenario. Three of the four OEM headquarters locations identified in Section 3.1 are found adjacent to the top ten ranked metros in the Base Scenario. Lake Nona is found within the Orlando-Kissimmee-Sanford, FL Metro Area and Marina and Mountain View are located in the vicinity of the San Jose-Sunnyvale-Santa Clara, CA Metro Area. Coinciding with the Base Scenario analysis, market penetration has been assessed using a Bass diffusion model (see “Bass Model Analysis” on page 77).

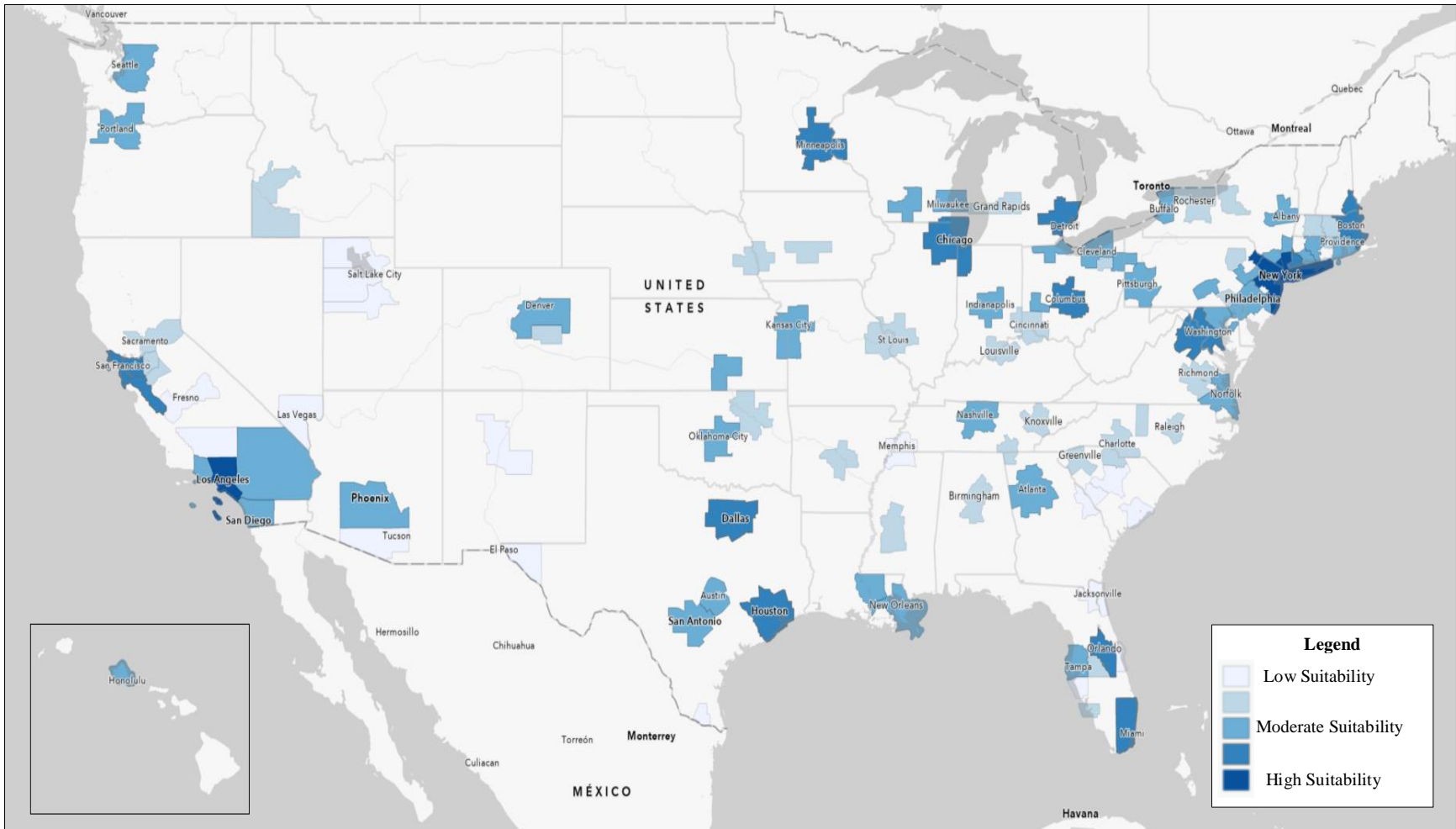

Figure 2.16. Site Suitability Analysis Results (ASSURE A36, 2022)

### 2.3.1.3 Additional Suitability Analysis Scenario Development

The Base Scenario represents a blended emphasis on urban structure and readiness categories. Variables in the readiness category primarily exhibit a low negative correlation with variables in the urban structure category (see Appendix Section 5.2), though the strength and direction of correlation varies. This scenario can therefore be thought of as balancing the inherent benefits of market scale with operational challenges arising in the country’s largest and busiest metros.

To examine the model’s sensitivity to weighting, the research team designed several additional scenarios that focus emphasis on each of the categories listed in Table 2.11. The full results of these additional scenarios are provided in Appendix Section 5.2.1. Among the scenarios analyzed, the Infrastructure Readiness Scenario resulted in the greatest absolute value of rank changes among the top 25 highest ranking metro areas in that scenario. This scenario emphasizes variables in the readiness category and deemphasizes variables in other categories in comparison to the Base Scenario. Because the readiness category includes variables that tend to have a moderate negative correlation with population density, many of the metropolitan areas that increase in rank under the Infrastructure Readiness paradigm are smaller metropolitan areas. Many are located on the periphery of some of the country’s largest metropolitan areas where major economic “pull” factors persist but structural “push” factors like airspace congestion and operational restrictions are diminished. Examples include metropolitan areas centered on Bridgeport, Allentown, Poughkeepsie, Oxnard, and Stockton. The top 25 highest ranking metros in the Infrastructure Readiness scenario and their rank changes relative to the Base Scenario are reported in Table 2.15.

Table 2.15. Most Suitable MSAs for AAM Passenger Services - Infrastructure Readiness Scenario (ASSURE A36, 2022).

Rank	Name	Score	Rank Change from Base Scenario
1	New York-Newark-Jersey City, NY-NJ-PA Metro Area	72.01	0
2	Los Angeles-Long Beach-Anaheim, CA Metro Area	57.54	0
3	Bridgeport-Stamford-Norwalk, CT Metro Area	44.77	+10
4	Dallas-Fort Worth-Arlington, TX Metro Area	43.92	-1
5	San Jose-Sunnyvale-Santa Clara, CA Metro Area	43.07	0
6	Columbus, OH Metro Area	42.29	+4
7	Allentown-Bethlehem-Easton, PA-NJ Metro Area	41.07	+13
8	Poughkeepsie-Newburgh-Middletown, NY Metro Area	40.47	+16
9	Oxnard-Thousand Oaks-Ventura, CA Metro Area	40.46	+26
10	Boston-Cambridge-Newton, MA-NH Metro Area	39.91	-6
11	Riverside-San Bernardino-Ontario, CA Metro Area	39.64	+5
12	Orlando-Kissimmee-Sanford, FL Metro Area	38.53	-6
13	San Francisco-Oakland-Berkeley, CA Metro Area	37.95	-4
14	Austin-Round Rock-Georgetown, TX Metro Area	37.58	+19
15	Houston-The Woodlands-Sugar Land, TX Metro Area	37.42	0
16	Chicago-Naperville-Elgin, IL-IN-WI Metro Area	37.29	-4
17	Minneapolis-St. Paul-Bloomington, MN-WI Metro Area	36.90	-6
18	Modesto, CA Metro Area	36.74	+52
19	Stockton, CA Metro Area	36.31	+45
20	Portland-Vancouver-Hillsboro, OR-WA Metro Area	36.24	+8
21	Baton Rouge, LA Metro Area	35.91	+16
22	Indianapolis-Carmel-Anderson, IN Metro Area	35.90	-4
23	Miami-Fort Lauderdale-Pompano Beach, FL Metro Area	35.71	-15
24	San Antonio-New Braunfels, TX Metro Area	35.21	+24
25	Oklahoma City, OK Metro Area	34.74	+22

### **2.3.2 Potential Size and Growth of the UAM Passenger Market**

Estimating the demand and growth potential of AAM markets is important for several reasons. First, the public sector needs to be fully aware of the potential size and growth of AAM to “unlock” or “channel” growth opportunities through changes in legislation or regulation. For example, aircraft certification protocols, airspace regulations, and public space and privacy laws all require reevaluation and fine-tuning to enable AAM market development. Second, understanding the potential demand for AAM helps private sector investments in aircraft and infrastructure development. Finally, estimating the market size, demand, and growth potential of AAM markets helps the public and private sectors understand the potential scale of economic impact or externalities associated with AAM, such as changes in employment, the built environment, equity, and quality of life impacts (Goyal et al., 2021).

Forecasting demand can be challenging, as service utilization will depend on the convergence of several factors, such as community acceptance, safety, social equity, regulatory adaptation, and infrastructure investment. While numerous societal concerns have been raised about these approaches (e.g., affordability, safety, privacy, multimodal integration, etc.), AAM has the potential to offer substantive enhancements for passenger mobility (Goyal et al., 2021).

Several market studies forecast the emergence of AAM passenger services within the decade. UAM Geomatics (2019, 2020, 2021) conducted three market studies examining more than 70 global cities. Their studies used a metanalysis approach of existing work coupled with an analytical forecasting model that included variables such as city demographics, infrastructure costs, aircraft and supply chain factors, demand assumptions, and community and regulatory constraints. These studies estimate a global market potential of \$233 billion to \$318 billion in 2040. Another study by Porsche Consulting (2018) estimates a global demand for 23,000 eVTOL aircraft in 2035. Meanwhile, a market analysis by KPMG (2019), estimates that air taxis could have upwards of 400 million enplanements representing four percent of domestic trips by 2050. Furthermore, a study by Deloitte (2021) estimates that the US AAM passenger market will be valued at \$58 billion by 2035.

Market forecasts differ because of variations in study scope and assumptions, such as geography, timeline, market segmentation, the inclusion of military applications of VTOL aircraft, and the treatment of macroeconomic variables like the COVID-19 pandemic (Goyal et al., 2021). The onset of the global COVID-19 pandemic has notably altered the trajectory of the AAM passenger market, and variations in market forecasts are evident. See “COVID-19 Related Impacts on UAM Passenger Market” on page 45 for more discussion on the pandemic and AAM market viability.

#### **2.3.2.1 UAM Passenger Demand Forecasting Approach**

Forecasting the potential size and growth of advanced passenger mobility markets requires an in-depth understanding of a number of key factors that affect supply and demand. To fully understand

#### **Methods for Estimating AAM Passenger Demand**

- Conducted a site suitability analysis to determine most suitable MSAs for AAM passenger mobility.
- Completed a meta-analysis of market research and conducted a deep dive of market forecasts for context.
- The UAM Geomatics online dashboard was reviewed, and US data were extracted.
- Used bass diffusion modeling aligned with study supply and demand side parameters to estimate demand over time.

these constraints, the research team conducted a comprehensive literature review, in which more than 100 journal articles, market analyses, industry reports, databases, and other resources were analyzed. The literature and data review resulted in a set of supply-side and demand-side criteria that affect AAM passenger market size and potential growth. These criteria include demand constraints such as public acceptance, regulatory barriers, cost and service characteristics in comparison with other travel options, and supply-side constraints such as existing airports, heliports, vertiports, and other ground infrastructure.

As discussed in the “Target Markets and Suitable Market Conditions” section, the research team leveraged a site suitability analysis from the ASSURE A36 project team that uses 13 geospatial variables as site-selection criteria to identify the top 100 most suitable markets for advanced passenger mobility (see Figure 2.16 for site suitability analysis results).

With the suitable markets identified, estimates of demand need to be created to understand the size and extent of the UAM passenger mobility market over time. A Bass Diffusion modeling framework was used for this evaluation.

### **2.3.3 Bass Model Analysis**

The Bass Model analysis section is designed to i) provide more context to the demand estimates established in the previous sections, ii) help gauge uncertainty around these estimates and create possible low, medium, scenarios for demand, and iii) provide a scalable framework for analyzing demand from initial UAM implementations and being able to use data from these implementations to update demand estimates. The remainder of the section is organized as follows: First, a general overview and introduction is given on Bass diffusion modeling. Then there is a discussion of how the Bass framework can be used to help analyze UAM demand. A process is outlined for taking initial city-level demand estimates and then utilizing diffusion modeling to create bounds for these estimates and explore different scenarios. Procedures are developed to help translate current demand estimates into estimates for metro areas starting in later periods and for combining different estimation scenarios.

#### **2.3.3.1 Overview of the Modeling Approach**

Diffusion models are used to model the growth of new products and services upon market entry. In these situations, conventional forecasting techniques are of limited use due to the lack of data. The overall idea behind diffusion modeling is that sales growth for new products and services often follows predictable patterns. By fitting functional forms of these patterns and tuning parameters, one can predict future sales growth of a new product or service.

The Bass model (Bass, 1969) implemented in this project is a widely used functional model for diffusion analysis. Overall, the model is a logistic-type model, with slow initial growth as a product gains traction among early adopters. As sales increase, network externalities take effect (Kauffman, McAndrews, & Wang, 2000) and the installed base begins to drive new sales. As the market becomes saturated, cumulative adoption reaches a peak and the growth in market penetration begins to slow (Golder & Tellis, 2004).

The formulation for the Bass model (Bass 1969), given as a differential equation proportional hazard model (Kumar and Klefsjö, 1994), is stated in (1).

$$f(t)/[1-F(t)] = p + qF(t) \quad (1)$$

Here  $f(t)$  is the proportion of new adoptions at time  $t$ ,  $F(t)$  is the cumulative proportions of adoptions,  $p$  is the coefficient of innovation, and  $q$  is the coefficient of imitation. The coefficient of innovation is a measure of the sales due to product “innovativeness” and competitive advantage over existing products or services. The coefficient of imitation is a measure of sales due to the current installed base and possible network externality effects.

Extensions to the Bass model include the variants of the Bass model that include marketing decision variables such as advertising and price (Sato, 2021), model competition with other products e.g., (Mahajan et al., 1993; Seol et al., 2012), and account for consumer heterogeneity (Bemmaor & Lee, 2002).

In the context of this project, the Bass model is used to predict the market penetration for UAM services in a range of metropolitan areas. While the Bass Model was originally formulated for consumer products it has been widely applied in services settings, for example new media services (Seol et al., 2012), telecommunications services (Radojičić et al., 2009; Turk & Trkman, 2012), , mobile application services (Kang & Park, 2019), and technology services for bottom-of-the-pyramid consumers (Ratcliff & Doshi, 2016). The Bass model is a demand-based model and does not assume any supply restrictions (Mahajan, Muller, & Bass, 1990). However, given a service rollout where local supply-side resources are required, supply side restrictions can be incorporated by including multiple diffusion curves, each of which “starts” when the supply resources are available for the segment of consumers associated with the diffusion curve (Velickovic et al., 2016). This is the approach taken in this analysis, with diffusion curves for individual metros starting at the estimated deployment dates.

The analysis relies on the demand data gathered in the previous section, but the methodology is general and could be used to help produce market penetration and size estimates from data gathered from multiple sources, from estimates of Bass parameters gained from previous similar transportation rollouts (e.g., Al-Alawi, B & Bradley, 2013), and from parameters derived from consumer surveys (e.g., Mahajan & Sharma, 1986). A variant of the Bass model is employed that, in addition to the  $p$  (innovation) and  $q$  (imitation) parameters, also calculates a third parameter,  $m$  (the overall market potential and eventual market saturation point).

Product diffusion in the context of UAM deployment differs from a pure product diffusion scenario in that the demand is “lumpy” and depends on specific UAM infrastructure being created. It may be that diffusion model estimates include latent demand that is only partially realized once a UAM service is deployed. To account for this, forecasts can be aggregated as a combination of full demand forecasts and delayed demand forecasts, where demand is synched relative to the service launch date.

### 2.3.3.2 Running the Bass Model

Annual demand data, collated for the site suitability analysis, detailed in the previous section, and summarized in five-year periods in Table 2.26 in the Appendix, were utilized to create Bass model estimates. The data contain yearly demand estimates for each city from 2022 to 2045. For each city, Bass model estimates for the  $p$  (innovation),  $q$  (imitation), and  $m$  (market size) parameters were calculated for each metro area from the yearly data using the “diffusion” package in R (Schaer & Kourentzes, 2018). This package contains a function that gives best fit parameters of  $p$ ,  $q$ , and

m from the data using likelihood estimation. Commented code for carrying out this procedure is given in *Appendix 2.7 Appendix C: Code for Bass Modeling* on page 139.

The resulting parameters are given in Table 2.16. In the context of this analysis, m is the overall market potential for the market, calculated from the initial demand data and can be thought of as a measure of overall market potential if the demand continues on the trajectory determined by the Bass model curve. Given the differing size of the metro areas, the market size - m parameters varied quite widely, though there was more consistency in the base diffusion parameters, particularly in the q (imitation) parameters.

Table 2.16. Bass Coefficients for All Cities.

All Cities	Bass-pIn	Bass-qIm	Bass-m
Los Angeles	0.001718	0.152374	25272774.74
New York	0.002630	0.143463	48543083.78
Dallas-Fort Worth-Arlington	0.000900	0.175966	41026852.81
Houston	0.001480	0.152243	14028673.49
Philadelphia	0.000226	0.184829	10057899.65
Chicago	0.002469	0.137974	22050223.15
Washington, DC	0.003499	0.120309	18308321.54
Detroit	0.000010	0.17625	8720740.883
Atlanta	0.002591	0.106727	12103825.93
Boston	0.000010	0.220699	10627127.4
Miami	0.002110	0.125363	8119520.024
New Orleans	0.000010	0.232683	4314819.463
Denver	0.001766	0.141571	11614767.87
Baltimore	0.001738	0.121676	8570717.358
Phoenix	0.000947	0.16089	12947269.7
Orlando	0.000979	0.153302	11092256.38
Hampton	0.000010	0.245449	4009187.695
Tampa	0.000630	0.165614	4195049.741
Columbus	0.000010	0.212438	6432710.397
Salt Lake City	0.001602	0.141284	3256680.589
Cincinnati	0.000010	0.214433	6080783.861
Seattle	0.003147	0.129197	9951499.287
Cleveland	0.000010	0.196714	5975878.004
Minneapolis-St. Paul	0.000010	0.198289	15355076
Portland	0.000978	0.315685	821191.0646
San Francisco	0.004225	0.073849	14331432.84
Akron	0.000010	0.262336	3487875.185
San Diego	0.001895	0.142316	5029392.561
Charlotte	0.001970	0.14842	7295827.338
Las Vegas	0.002040	0.107478	8397099.642
Dayton	0.000010	0.263859	2711468.339
Toledo	0.000225	0.268587	2020965.744



All Cities	Bass-pIn	Bass-qIm	Bass-m
Reno	0.001997	0.132628	1763637.8
Raleigh-Durham-Chapel Hill	0.000659	0.19142	4973883.468
Syracuse	0.000543	0.274189	1527549.622
Wichita	0.000335	0.302084	1182524.923
Nashville	0.001563	0.14888	2396166.785
San Jose	0.005464	0.093667	2393330.194

To gauge the range of the parameters, symmetric bootstrap confidence intervals (Hall, 1988) were created for the parameters using the “boot” package in R (Canty, 2002). These intervals are summarized in Table 2.17. Confidence intervals were created at three different confidence levels, 90%, 95%, and 99%. Relative to the size of the coefficients, the q (imitation) parameters, with a 95% confidence interval ranging from 0.15998 to 0.196501, are slightly more consistent than the p (innovation) parameters, which have a 95% confidence interval from 0.000946 to 0.001757.

Table 2.17. Bootstrap Confidence Intervals for Confidence Coefficients.

Parameter	Median	Low-90%	High-90%	Low-95%	High-95%	Low-99%	High-99%
<b>Bass-pIn</b>	0.00133	0.001006	0.001688	0.000946	0.001757	0.000752	0.001897
<b>Bass-qIm</b>	0.17703	0.161318	0.193776	0.159998	0.196501	0.152407	0.203139

### 2.3.3.3 Analysis of Bass Coefficients

To further examine the antecedents of the p (innovation) and q (imitation) Bass coefficients, regressions were run with these coefficients as the dependent variables and the metro characteristics as the independent variables. The rationale behind carrying out these regressions is as follows: First, given demand estimates at the city level, the results of regression give more insight into how the metro area characteristics affect both potential market size and diffusion characteristics. Second, given no previous demand estimates, the regressions can be used to estimate Bass coefficients (scaled or unscaled) to create demand estimates. Third, once UAM is deployed in the first metros and real diffusion data are available, the regressions could be used to incrementally improve parameter estimation and estimate parameters for future UAM metro deployments.

The metro population and the constituent variables of the SSA index were included as candidate independent variables. For each of the regressions, a forward stepwise regression procedure (e.g., Henderson & Denison, 1989) was used. At each stage variables that gave the best increase in model fit were added until the model fit could no longer be improved (Bendel & Afifi, 1977). To give meaningful values of coefficients (i.e., > 0.00 to 3 significant figures), the Bass parameters were scaled, with each of the parameter values multiplied by 1000 for p (innovation) values and by 100 for q (imitation) values. The resulting model for the p (innovation) factor is given in Table 2.18. Here, the significant variables at  $p < 0.01$  are ES2 - GDP per Capita (+ve), R1 - Heliports per Capita (-ve), R3 - Class B Airspace (0 present, 1 not present) (-ve), C3 - Airport to CBD Drive Time (+ve), and US1 - Population Density (-ve). The variable C2 - Travel Time Index is included and adds to the overall model fit but is not statistically significant. The model fit was strong, with

$R^2 = 0.854$ , giving 85% of variance in the  $p$  (innovation) parameters explained by the model. Overall, the model indicates that richer (GDP per Capita), larger (Class B Airspace and longer Airport to CBD Drive Time) have higher levels of innovation. The Heliports per Capita variable is significantly negative. As per the “Site Suitability Analysis: Psychometric Validation” section, this variable tends to be higher for smaller metros, so this is another indicator that larger metros have higher degrees of innovation.

Table 2.18. Regression of Bass  $p$  (Innovation) Coefficients Against SSA Variables.

<i>Predictors</i>	<i>Estimates</i>	<b>Bass-pIn</b>	
		<i>CI</i>	<i>p</i>
(Intercept)	-7.52	-18.26 – 3.23	0.163
ES2 - GDP per Capita	0.03	0.02 – 0.05	<b>&lt;0.001</b>
R1 - Heliports per Capita	-92076.64	-124296.97 – -59856.30	<b>&lt;0.001</b>
R3 - Class B Airspace (1 not present)	-0.74	-1.23 – -0.26	<b>0.004</b>
C3 - Airport to CBD Drive Time	0.03	0.01 – 0.06	<b>0.002</b>
US1 - Population Density	-0.00	-0.00 – -0.00	<b>0.002</b>
C2 - Travel Time Index	6.96	-3.44 – 17.36	0.182
Observations	36		
$R^2$ / $R^2$ adjusted	0.854 / 0.823		

To help validate the estimates, the regression was tested for multicollinearity, by calculating Variance Inflation Factors (VIFs). No significant multicollinearity was found, with all VIF values being less than 5 (e.g., Salmerón et al., 2018). Residual plots for the regression are given in Figure 2.17. The residuals are relatively constant with respect to the fitted values, which indicates a degree of homoscedasticity. The normal Quantile-Quantile (Q-Q) plot shows a relatively tight fit of the residuals to those expected with the normal distribution. Thus, the regression assumptions of normal, homoscedastic errors hold. The leverage plot does not show any residuals with a Cook’s distance greater (Cook, 1977) than 0.5 or 1, indicating no overly influential observations.

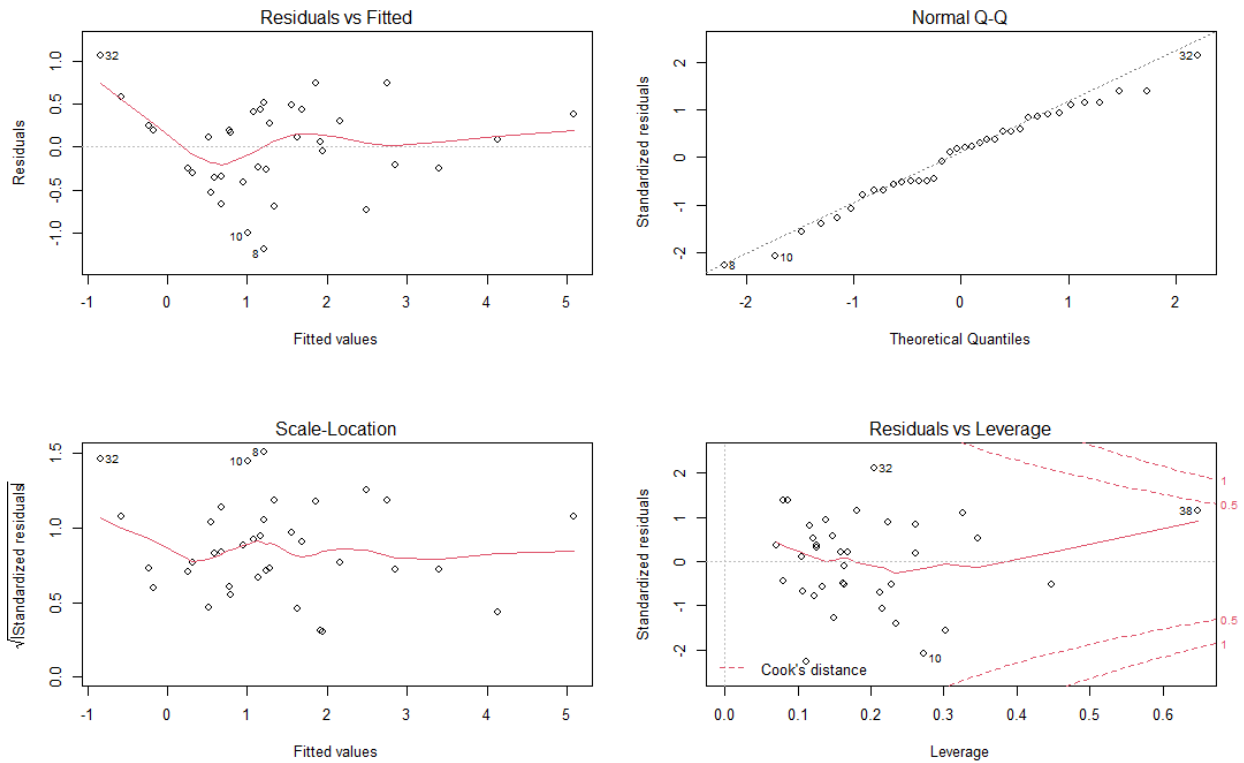

Figure 2.17. Regression of Bass p (Innovation) Residual Plots.

The resulting model for the q (Imitation) parameter is given in Table 2.19. Here, the significant variables at  $p < 0.01$  are heliports per capita (+ve) and class B airspace not present (+ve). At  $p < 0.05$ , airports per capita (+ve) and population density (+ve) are significant. Average time to work (-ve) and GDP per Capita (-ve) add to the model fit but are not statistically significant at  $p < 0.05$ . The overall  $R^2$  is 0.766, which is a little lower than for the p (innovation) parameter, but still indicates a high degree of variance accounted for in the model. There is less overall pattern than for the p (innovation) parameter, though most of the significant indicators (shorter average time to work, more heliports per capita and no class B airspace) align with smaller metro areas. It may be that while smaller metros have less “innovation” characteristics, once there is an installed base, network affects are more pronounced due to stronger, more compact social ties in smaller metro areas.

Table 2.19. Regression of Bass q (Imitation) Coefficients Against SSA Variables.

<i>Predictors</i>	<b>Bass-qIm</b>		
	<i>Estimates</i>	<i>CI</i>	<i>p</i>
(Intercept)	22.41	8.72 – 36.09	<b>0.002</b>
R2 - Airports per Capita	106619.72	10903.78 – 202335.67	<b>0.030</b>
C1 - Average Time to Work	-0.42	-0.93 – 0.08	0.099
US1 - Population Density	0.00	0.00 – 0.01	<b>0.024</b>
R1 - Heliports per Capita	290856.86	108646.96 – 473066.76	<b>0.003</b>
R3 - Class B Airspace (1 not present)	5.90	2.48 – 9.32	<b>0.001</b>
ES2 - GDP per Capita	-0.05	-0.11 – 0.01	0.119
Observations	36		
R <sup>2</sup> / R <sup>2</sup> adjusted	0.766 / 0.717		

As with the previous regression, the regression coefficients were tested for multicollinearity and all VIF values were found to be less than 5. Residual plots for the regression are given in Table 2.19. As per the graphs for the previous regression, the residuals are relatively constant with respect to the fitted values and normal Q-Q plot shows a good fit, so the regression assumptions of normal, homoscedastic errors hold. Again, the leverage plot does not show any residuals with a Cook's distance greater than 0.5 or 1, indicating no overly influential observations.

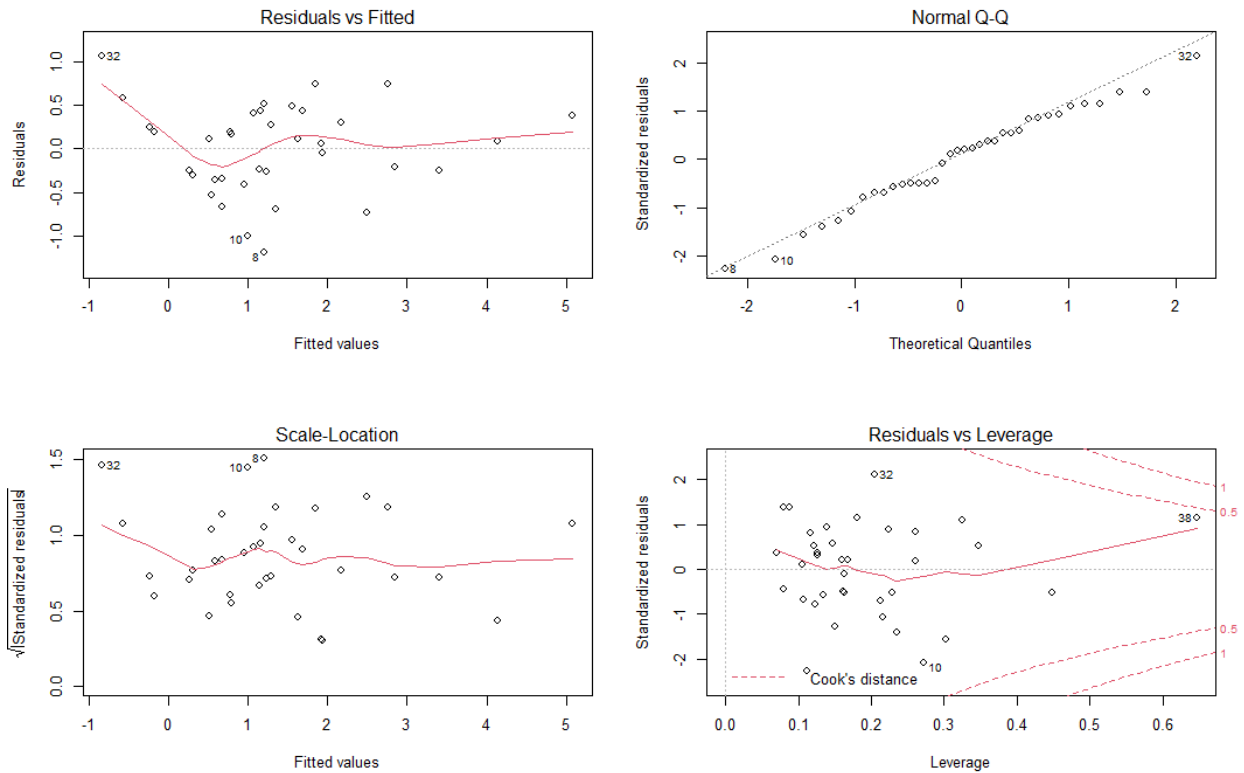

Figure 2.18. Regression of Bass q (Imitation) Residual Plots.

### 2.3.3.4 Overall Forecasts and What-If Analysis

The example demand data for the Bass analysis were adapted from UAM Geomatics (2021a, 2021b) website. These data assume demand starting in 2022 for all metros. However, most of this demand in the initial years of the analysis will remain untapped due to UAM requiring large-scale investment and infrastructure development from one or more commercial providers before any commercial passenger service can take place. In the previous section, it was described how the implementation date of UAM was estimated for each of the metro areas. Given a situation where the actual implementation of UAM occurs several years after the start of diffusion demand estimates, it is likely that the demand will be somewhere between two poles:

- The demand in the year of implementation will be the same as the demand estimated for the first year of demand estimate (in this case 2022).
- Given the growth in latent consumer demand, the demand in the first year of implementation will be equal to the demand estimated for this implementation year.

For example, it is estimated that the initial implementation of UAM in Dallas will be in 2028. It is likely that demand for Dallas in 2028 will be intermediate to the forecast demand in Dallas in 2022 and the forecast demand in Dallas in 2028. To account for this issue, a scaling constant was used. Let this scaling factor  $\lambda$  be the proportion of demand that is taken from the delayed demand, i.e., the original predicted demand for the first year of forecast and let  $1 - \lambda$  be the proportion of

demand taken from the current year estimate of demand. Using the example, let the Originally Predicted Demand (OPD) in Dallas in year Y be  $OPD_Y$ . The Aggregate Predicted Demand (APD) in Dallas in year 2028 can be calculated as (2)

$$APD_{2028} = \lambda OPD_{2028} + (1 - \lambda) OPD_{2028}. \quad (2)$$

A spreadsheet tool was developed in Excel to help produce estimates of future demand for UAM using Bass model simulations and analysis. A screenshot from the spreadsheet is given in Figure 2.19. Estimates were created for different values of p and q. The final demand estimate is created as a user-defined mixture of the different innovation/imitation scenarios. This allows for different estimates under different data scenarios and also for what-if analyses across different parameterizations of the Bass model. Each metro area has a start date for estimated UAM implementation. It is likely that these will change as commercial UAM providers alter plans, enter new markets, and leave markets.

	C	E	F	G	H	I	J	K	L	M
1	City	2022	2023	2024	2025	2026	2027	2028	2029	2030
2	Los Angeles	36635.53	80285.23	132260.1	194102.6	267622.3	354933.5	458496.1	581156.1	726184.5
3	New York	70368.27	154209.1	254040.7	372825.7	514039.8	681744.2	880663.8	1116265	1394830
4	Dallas-Fort Worth-Arlington	59472.71	130332	214705.9	315098.8	434447.8	576185.5	744305	943426.5	1178860
5	Houston	20336.03	44565.56	73416.3	107744.5	148554.6	197020.2	254506.8	322594.1	403098
6	Philadelphia	14579.98	31951.41	52636.04	77247.75	106506.6	141254.2	182469.4	231284.8	289002.3
7	Chicago	31964.1	70048	115395.5	169352.5	233497.6	309675.7	400032.9	507052.4	633588.1
8	Washington, DC	26539.82	58160.92	95812.99	140613.5	193873.3	257124	332147.7	421006.1	526068.8
9	Detroit	12641.62	27703.59	45638.28	66977.96	92346.99	122475	158210.8	200536.4	250580.6
10	Atlanta	17545.76	38450.8	63342.99	92961.09	128171.7	169987.4	219586.4	278331.6	347789.7
11	Boston	15405.13	33759.7	55614.98	81619.59	112534.4	149248.5	192796.3	244374.4	305358.4
12	Miami	11770.09	25793.67	42491.91	62360.4	85980.46	114031.4	147303.5	186711.1	233305.2
13	New Orleans	6254.781	13707.09	22580.76	33139.13	45691.14	60597.78	78279.02	99220.75	123981.4
14	Denver	16836.82	36897.19	60783.6	89204.97	122992.9	163119	210714	267085.6	333737.2
15	Baltimore	12424.15	27227.01	44853.16	65825.73	90758.34	120368.1	155489.1	197086.6	246269.8
16	Phoenix	18768.42	41130.21	67756.98	99438.99	137103.2	181832.8	234888.1	297726.9	372025.1
17	Orlando	16079.38	35237.3	58049.14	85191.92	117459.8	155780.8	201234.6	255070.2	318723.4
18	Hampton	5811.736	12736.18	20981.29	30791.79	42454.7	56305.46	72734.28	92192.64	115199.5
19	Tampa	6081.163	13326.62	21953.97	32219.27	44422.86	58915.72	76106.17	96466.6	120540
20	Columbus	9324.886	20435.1	33664.32	49405.18	68118.23	90341.67	116701.6	147922.4	184836.6
21	Salt Lake City	4720.899	10345.65	17043.2	25012.3	34486.14	45737.17	59082.37	74888.48	93577.02

Figure 2.19. Example Bass Output: Median p/Median q.

The following data scenarios were included in the initial version of the spreadsheet. These utilized the bootstrap confidence interval estimates for the innovation p and imitation q parameters summarized in Table 2.17. The data scenarios are given below:

- Original Data: The data gathered for the analyses in the previous section, primarily from the UAM Geomatics website (UAM Geomatics 2021a, 2021b).
- SmoothedCurve: The original data were smoothed by calculating Bass parameters on the original data and then creating predictions based on these parameters, with demand for each metro area being predicted using the Bass parameters calculated for that metro area.

- MedianpqCurve: Demand data were calculated using the median values of the p and q parameters calculated across all metros, but with the market size m parameter calculated for the specific metro.
- LowpLowqCurve: Demand data were calculated using the lower bound values of 95% bootstrap confidence intervals derived for the p and q parameters calculated across all metros, with the market size m parameter calculated for the specific metro.
- LowpHighqCurve: As LowpLowqCurve above, but the upper bound value of the 95% confidence interval is used for q.
- HighpLowqCurve: As LowpLowqCurve above, but the upper bound value of the 95% confidence interval is used for p.
- HighpHighqCurve: As LowpLowqCurve above, but the upper bound value of the 95% confidence interval is used for both p and q.

The macro for merging estimates is found on the “Run” sheet of the spreadsheet. The macro has several setup parameters. These parameters can be configured and then pressing the “Run” button creates the demand estimates. A screenshot of the configuration information is given in Figure 2.20. While the six worksheets listed above were included in the initial spreadsheet, it would be possible to include additional estimates, for example by using different sets of Bass parameters, different source data, or different classes of diffusion models, such as Gompertz and extended Gompertz models (e.g., Kyurkchiev & Iliev, 2018; Sood et al., 2012). For example, Bass parameters can be generated using surveys of consumers or experts (Mahajan et al., 1990) and estimates for UAM potential could be created from logit choice models.

	A	B	C	D	E	F
1	<b>Control Panel</b>					
2	Proportion Delay	0.5				
3	Info Columns	4				
4						
5	<b>Curve Mixture</b>					
6	OriginalData					
7	MedianpqCurve					
8	LowpLowqCurve	0.5				
9	LowpHighqCurve					
10	HighpLowqCurve					
11	HighpHighqCurve	0.5				
12						
13						

Figure 2.20. Merge Macro Input.

The proportion delay is the previously described  $\lambda$  parameter and controls the proportion of the demand that is taken from the first-year demand is calculated relative to the market entry year vs. the demand calculated for the year assuming no market entry constraints. There is a constraint on the  $\lambda$  parameter in that  $0 \leq \lambda \leq 1$ .

The curve mixture section of the spreadsheet allows a mixture of the different estimates. For example, it may be that the best estimate is somewhere between one calculated with the individual

metro parameters and one calculated with aggregate parameters for  $p$  and  $q$ , but with specific market size  $m$  parameters.

### 2.3.3.5 Example for the Los Angeles Metropolitan Area

This section gives an example of creating overall demand estimates for the Los Angeles metropolitan area. First, Los Angeles demand data<sup>8</sup> summarized in the SSA spreadsheet from 2022-2045 was fitted using the Bass model to create estimates of  $p$  (innovation),  $q$  (imitation), and  $m$  (market size) parameters. The values of the parameters are ( $p = 0.001718$ ,  $q = 0.152374$ , and  $m = 25272774.74$ ). These parameters were used to then create the Bass model demand curves described in the previous section. Figure 2.21 contains a plot of annual trips with the original demand series, and the smoothed data series, calculated from the derived Bass parameters. There is a strong concordance between the series, with both series rising from low initial demand to demand between 7,000,000 and 8,000,000 annual trips in 2045.



Figure 2.21. Los Angeles Annual Trips for Original and Smoothed Data Series.

Figure 2.22 contains the smoothed data series, calculated from the Los Angeles Bass parameters, along with series created with the Los Angeles market size parameter, median  $p$  and  $q$  parameters,  $p$  and  $q$  parameters at the lower bounds of the 95% confidence intervals for the parameters, and  $p$  and  $q$  parameters at the upper bounds of the 95% confidence intervals for the parameters. The smoothed Los Angeles series starts off higher than the series for median  $p$  and  $q$  parameters (due to a higher innovation parameter than average), but then trends lower (due to a lower imitation parameter than average). Both of these series estimate annual demand of around 8,000,000 million trips in 2045. The low and high series estimate annual demand of just under 6,000,000 million trips and just over 12,000,000 trips respectively in 2045. Given a large amount of demand

<sup>8</sup> Demand data is taken from that used in the site suitability analysis, collated from UAM Geomatics and other sources



uncertainty for both UAM and uncertainty about commercial deployments, these estimates provide good lower and upper bounds for market planning.

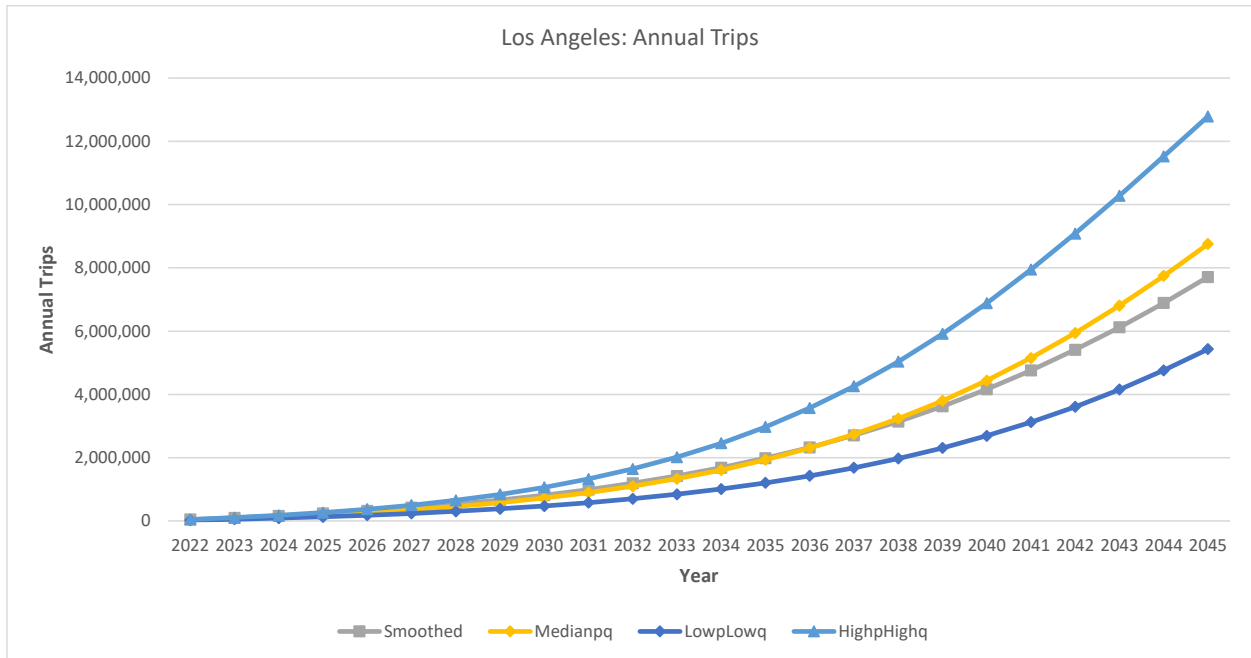

Figure 2.22. Los Angeles Annual Trips for Smoothed and Aggregate pq Data Series.

Given the current state of commercial deployments as summarized in Table 2.27 and Table 2.28 in the appendix, a start year of 2024 is assumed as reasonable for commercial deployment of UAM in Los Angeles. The previously described spreadsheet macro can be used to merge estimates and to trade-off different delay scenarios. Figure 2.22 gives demand scenarios for the smoothed Los Angeles data series, with different values of the delay proportion  $\lambda$ . The PropDelay ( $\lambda$ ) = 1 series uses the estimates for 2022 for 2024, with each subsequent data series taking the estimates from two years previously. The PropDelay ( $\lambda$ ) = 0 series assumes that latent increasing demand is met by the new UAM implementation(s), so the 2024 demand is taken from the original 2024 estimate. The PropDelay ( $\lambda$ ) = 0.5 series assumes demand in between the two demand points and is an equally weighted sum of the other two series.

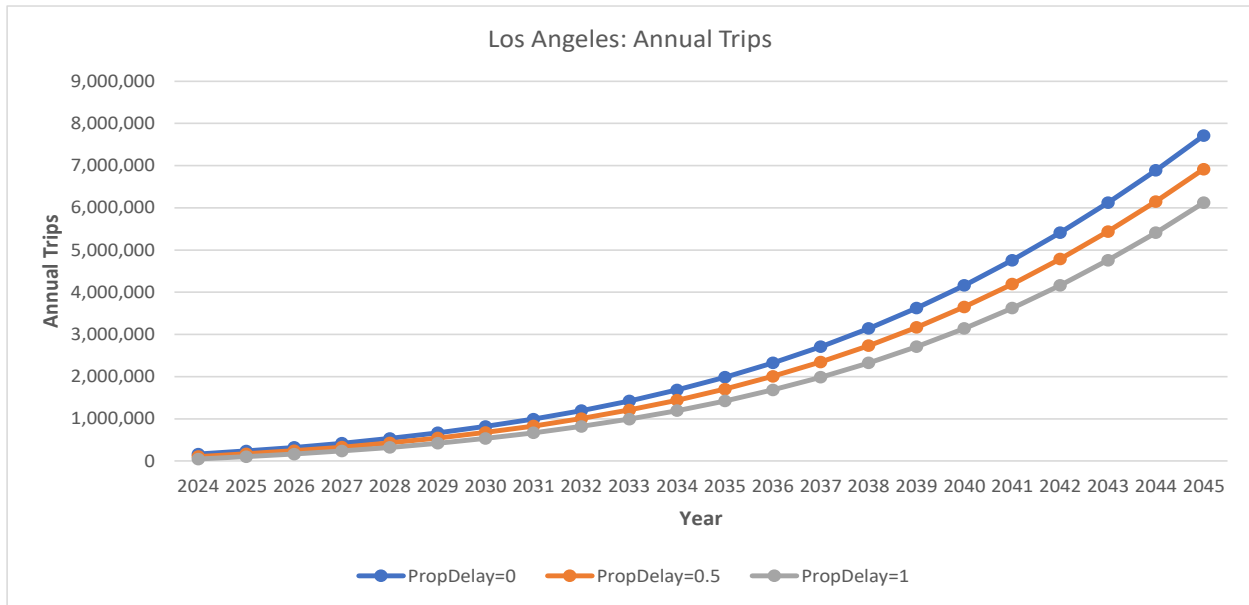

Figure 2.23. Los Angeles Annual Trips for Smoothed Data Series and Different Delay Levels.

There is only a small difference between the different series in Figure 2.23. This is because the estimated implementation is only delayed two years from the initial data estimate. For longer delays, the differences between the series will be larger.

This section has shown examples of Bass diffusion curves based on the estimated Los Angeles demand data and has shown how different demand curves can be plotted with different assumptions regarding diffusion parameters and delayed demand. Any of the curves displayed in this section could be combined using the curve mixture feature of the associated Excel macro. For example, the Bass parameters could be “damped” using a combination of individual parameters (e.g., the smoothed series) and one of the aggregate parameter series.

### 2.3.3.6 Bass Modeling Summary

The methodology developed here is capable of synthesizing demand estimates by taking Bass parameter estimates, calculating demand over time from these estimates, judiciously combining different estimates of demand, and creating delayed estimates given information on future UAM deployments.

There are several limitations to the current analysis. Though the methodology described in this chapter is general, the demand estimates are based on utilizing a single set of source demand estimates. The methodology is general and other sources of demand estimates could be utilized, including demand estimates from other data sources (e.g., KPMG/Booz Allen Hamilton), and from dedicated stated-preference surveys.

As commercial UAM services have not yet been deployed, all estimates are projected, and the Bass parameters are calculated from these estimates. Once initial implementations are started, it will be possible to estimate Bass parameters from real data, which will ground the estimates. The  $\lambda$  - proportion of delay parameter is used to control the trade-off between the unconstrained latent predicted demand assuming no service limitations and initial low demand for services started in

the future. As with the Bass parameters, it is difficult to further tune this parameter until data are available from real-world implementations.

### 2.3.4 Overall Demand Modeling Findings

Assuming no substantial negative changes in public, regulatory, and political support, the US will be a leading market for advanced passenger mobility with forecasted growth in major metropolitan areas. Similar to other nascent technologies, it is anticipated that AAM passenger services will go through a slow initial growth period before a phase of rapid growth.

To forecast demand, the research team used UAM Geomatics city demand projections, fitted them to the top 30 metropolitan statistical areas (MSAs) identified during the outcome of the site suitability analysis, applied an initial start year of 2024 and phased market growth based on academic and industry consensus for UAM launch cities, and then fitted demand to diffusion modeling parameters  $p$ ,  $q$ , and  $m$ .<sup>9</sup> Using the median  $pq$  curve results from diffusion modeling,<sup>10</sup> it was found that in the year 2045 approximately 85.4 million domestic AAM passenger flight operations are projected to occur, as shown in Table 2.20. It is important to note that only 30 of the 100 most suitable MSAs were assumed to have viable advanced passenger mobility operations through the analysis period (2024-2045) with operations in MSAs beginning at different start years.

Table 2.20. Domestic AAM Passenger Mobility Demand: Number of Flights.

Study	2022	2025	2030	2035	2040	2045
UAM Geomatics (2019)	3,751,150	4,741,210	19,314,830	28,840,730	59,540,300	123,122,360
UAM Geomatics (2020)	1,493,330	4,500,010	16,856,840	30,589,520	63,186,110	119,663,920
UAM Geomatics (2021)	411,980	4,278,290	17,341,850	29,864,320	61,457,850	105,497,210
KPMG (2019)	--	--	2,500,000	--	22,600,000	--
Booz Allen Hamilton (2018)	--	--	20,075,000	--	--	--
<b>ASSURE (2022)</b>	--	<b>295,530</b>	<b>3,881,730</b>	<b>15,354,580</b>	<b>40,566,200</b>	<b>85,390,550</b>

<sup>9</sup> The site suitability analysis was conducted to demonstrate the top 100 most suitable domestic locations for advanced passenger mobility operations. It was assumed that only 30 MSAs would experience viable operations prior to 2046 based on UAM market trajectories reviewed in an extensive market analysis (see A36 Work Package Market Analysis for the 100+ resources reviewed to determine the factors that influence AAM demand). Among these resources, Hussain and Silver (2021) offered a meaningful guidepost of temporal validation of the A36 diffusion model results, which estimated demand by MSA over time.

<sup>10</sup> The  $p$ -variable refers to innovation and  $q$ -variable refers to imitation.

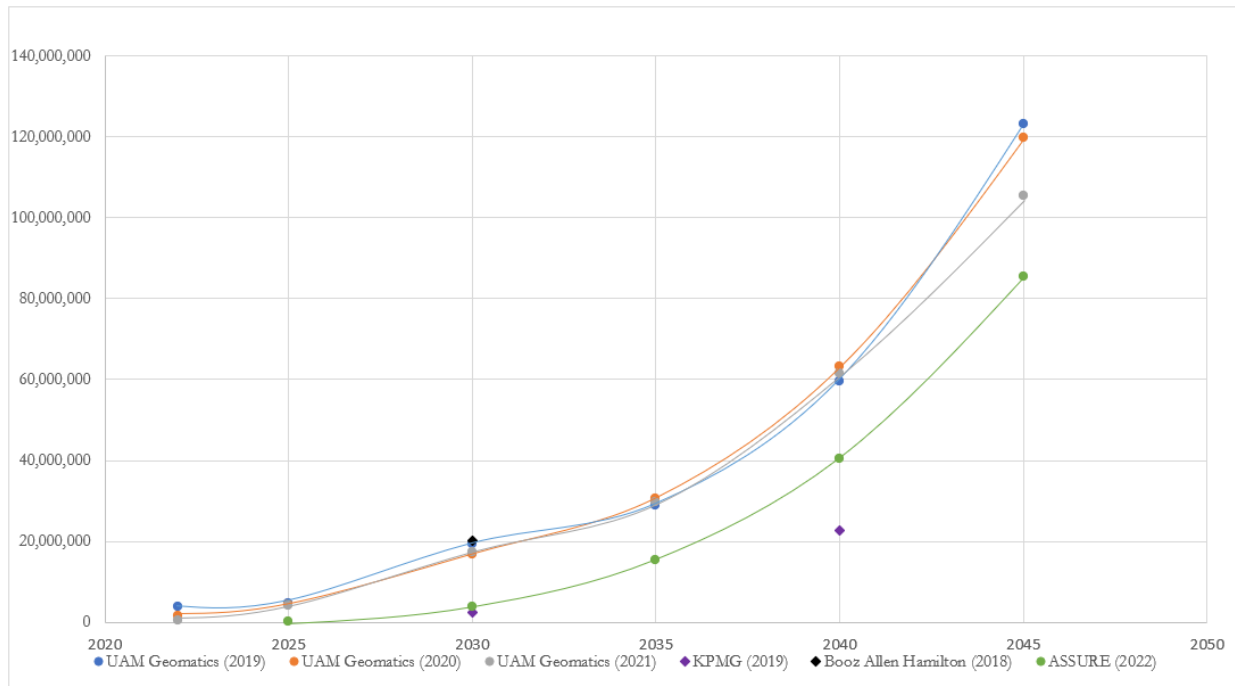

Figure 2.24. Projected Annual Passenger Trips Over Time.

AAM passenger demand and associated ticket revenue are anticipated to be highly correlated to ticket price. It is expected that economies of scale, technological advances, strong market competition, and the drive to capture market share will be the primary factors that decrease AAM passenger ticket fares over time (UAM Geomatics, 2021). Once ticket prices fall, AAM passenger mobility will become more affordable and attractive to consumers. Table 2.21 shows estimated AAM passenger mobility ticket prices over time. Goyal et al. (2021) ticket prices were estimated using an average trip length of 26 miles (as estimated by Joby Aviation) and their operational recoup requirements if one, two, three, and four seats are occupied by passengers and an additional seat is occupied by a pilot. UAM Geomatics (2021) and Blade (2021) prices were available online and did not require additional cost estimation.

Table 2.21. Estimated AAM Passenger Mobility Ticket Prices Over Time (2022 USD).

Study	Type	2022	2025	2030	2035	2040	2045
Blade (2021)	Helicopter	\$195	(no data)	(no data)	(no data)	(no data)	(no data)
UAM Geomatics (2021)	VTOL or eVTOL	\$325	\$325	\$208	\$156	\$104	\$104
Goyal et al. (2021)	VTOL or eVTOL (one seat filled+ pilot)	(no data)	(no data)	\$296	(no data)	(no data)	(no data)
	VTOL or eVTOL (two seats filled + pilot)			\$220			
	VTOL or eVTOL (three seats filled + pilot)			\$182			
	VTOL or eVTOL (four seats filled + pilot)			\$163			

Pairing UAM Geomatics estimated ticket prices by market with passenger demand over time, the potential size of the US market can be estimated. Cumulative revenue for AAM passenger mobility is shown in Table 2.22 and Figure 2.25. Using the team estimates that cumulative revenue will be \$150 million in 2025 and reach \$72.48 billion by 2045 (revenue estimates provided in 2022 USD).

Table 2.22. Domestic AAM Passenger Mobility Demand: Cumulative Revenue (2022 USD Billions).

Study	2022	2025	2030	2035	2040	2045
UAM Geomatics (2019)	\$1.54	\$15.85	\$34.14	\$59.58	\$93.23	\$155.60
UAM Geomatics (2020)	\$0.61	\$7.17	\$24.46	\$47.43	\$83.14	\$143.76
UAM Geomatics (2021)	\$0.17	\$2.97	\$19.45	\$42.71	\$77.47	\$130.98
Deloitte (2021)	--	\$5.00	\$17.00	\$58.00	--	--
Booz Allen Hamilton (2018)	--	\$2.50	--	--	--	--
<b>ASSURE (2022)</b>	--	<b>\$0.15</b>	<b>\$2.70</b>	<b>\$10.84</b>	<b>\$32.54</b>	<b>\$72.48</b>

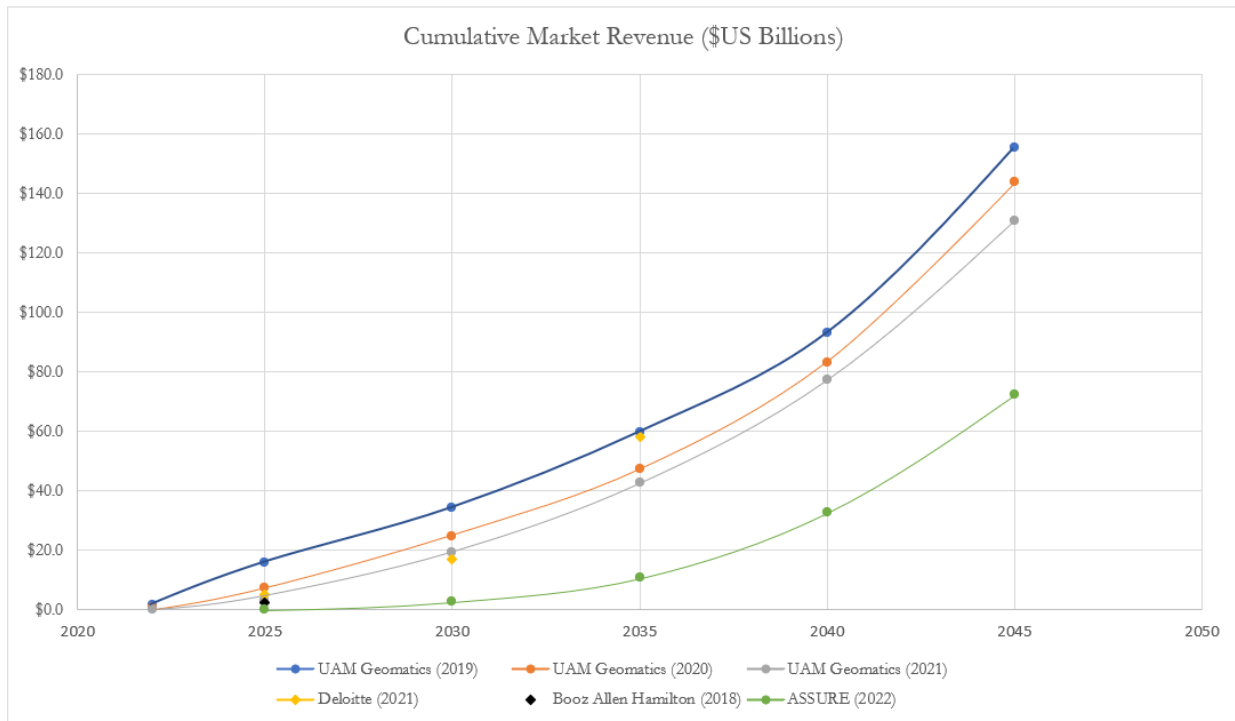

Figure 2.25. AAM US Passenger Market Revenue Projections Over Time (Revenue in \$US Billions).

## 2.4 References

- Abbot Aerospace Canada . (2020). December 2020 Newsletter. Ontario: AbbotAerospace.com.
- Airport Cooperative Research Program (ACRP). (No Date). Types of Aircraft Utilized for Air Cargo. Online: <https://crp.trb.org/acrpwebresource1/types-of-aircraft-utilized-for-air-cargo/>
- Alamalhodaie, A. (2021a). Autonomous Aviation Startup Xwing Hits \$400M Valuation After Latest Funding Round. Online: <https://techcrunch.com/2021/04/15/autonomous-aviation-startup-xwing-hits-400m-valuation-after-latest-funding-round/>
- Alamalhodaie, A. (2021, Jul. 27). *Joby Aviation, aiming to go to market in 2024, completes 154-mile test flight*. <https://techcrunch.com/2021/07/27/joby-aviation-aiming-to-go-to-market-in-2024-completes-154-mile-test-flight/>.
- Alcock, C. (2020, Nov. 11). *Lilium Unveils Plans for Florida Air Mobility Network*. <https://www.ainonline.com/aviation-news/business-aviation/2020-11-11/lilium-unveils-plans-florida-air-mobility-network>.
- Al-Alawi, B. M., & Bradley, T. H. (2013). Review of hybrid, plug-in hybrid, and electric vehicle market modeling studies. *Renewable and Sustainable Energy Reviews*, 21, 190-203.
- Ancel, E., Helsel T., and Heinich, C. Ground Risk Assessment Service Provider (GRASP) Development Effort as a Supplemental Data Service Provider (SDSP) for Urban Unmanned Aircraft System (UAS) Operations. *IEEE/AIAA 38th Digital Avionics Systems Conference (DASC), San Diego, CA, USA, 2019, pp. 1-8, doi: 10.1109/DASC43569.2019.9081659*.
- Antcliff, K.R. (2016). Silicon Valley as an Early Adopter for On-Demand Civil VTOL Operations. *Hampton: NASA*.
- Antcliff, K.R. and Silva, C. Baseline Assumptions and Future Research Areas for Urban Air Mobility Vehicles. *AIAA Scitech Forum 7-11 January 2019 San Diego, California* <https://doi.org/10.2514/6.2019-0528>
- Aretskin-Hariton, E., Schnulo, S. Hendricks, E. and Chapman, J. Electrical Cable Design for Urban Air Mobility. *AIAA Scitech 2020 Forum. 6-10 January 2020. Orlando, FL* <https://doi.org/10.2514/6.2020-0014>
- Avni, A., Burley, P., Casey, P., Cherney, J., Christiansen, L., Daly, J. S., ... & Yu, H. (2015). Literature searches and literature reviews for transportation research projects. How to search, where to search, and how to put it all together: Current practices. *Transportation Research Circular, (E-C194)*.
- Balac, M., Rothfield, R., and Sebastian, H. (2019). The Prospects of On-Demand Urban Air Mobility in Zurich, Switzerland. <https://doi.org/10.3929/ethz-b-000355676>.
- Baltic Exchange Airfreight Index. (2022). Online: <https://www.aircargonews.net/data-hub/airfreight-rates-tac-index/>
- Barron, J., & Hollingshead, J. (2002). Making segmentation work. *Marketing Management, 11*(1), 24.

- Bass, F. M. (1969). A new product growth for model consumer durables. *Management Science*, 15(5), 215-227.
- Bauranov, A. and Rakas, J. Urban Air Mobility and Manned eVTOLs: Safety Implications. *IEEE/AIAA 38th Digital Avionics Systems Conference (DASC), San Diego, CA, USA, 2019, pp. 1-8, doi: 10.1109/DASC43569.2019.9081685.*
- Bemmaor, A. C., & Lee, J. (2002). The impact of heterogeneity and ill-conditioning on diffusion model parameter estimates. *Marketing Science*, 21(2), 209-220.
- Bendel, R. B., & Afifi, A. A. (1977). Comparison of stopping rules in forward “stepwise” regression. *Journal of the American Statistical Association*, 72(357), 46-53.
- Bertram, J. and Wei, P. An Efficient Algorithm for Self-Organized Terminal Arrival in Urban Air Mobility. *Iowa State University. DOI: 10.2514/6.2020-0660*
- Bertram, J. and Wei, P. (2020). Distributed Computational Guidance for High-Density Urban Air Mobility with Cooperative and Non-Cooperative Collision Avoidance. *Iowa State University.*
- Bijjahalli, S., Sabatini, R., and Gardi, A. (2019) GNSS Performance Modelling and Augmentation for Urban Air Mobility. *Sensors 2019, 19, 4209; doi:10.3390/s19194209.*
- Binder, R. B., Garrow, L. A., German, B. J., Mokhtarian, P. L., Daskilewicz, M. J., & Douthat, T. H. (2018). If You Fly It, Will Commuters Come? Predicting Demand. Atlanta : Georgia Institute of Technology.
- Black and Veatch. (2019) Powered for Take Off: NIA-NASA Urban Air Mobility Electric Infrastructure Study. Online: <https://www.bv.com/resources/nia-nasa-urban-air-electric-infrastructure-study>
- Blade (2022). BLADE Airport. Online: [https://www.blade.com/nyc-airports?gclid=Cj0KCQiA09eQBhCxARIsAAYRiylnegclR6H5\\_M5A3j\\_AX8CqHkcDBxVMQRb-3aAr-\\_GP8qqdqwicVjwaAuk6EALw\\_wcB&gclid=aw.ds](https://www.blade.com/nyc-airports?gclid=Cj0KCQiA09eQBhCxARIsAAYRiylnegclR6H5_M5A3j_AX8CqHkcDBxVMQRb-3aAr-_GP8qqdqwicVjwaAuk6EALw_wcB&gclid=aw.ds)
- Bogaisky, J. (2021). Electric Air Taxi Maker Joby Goes Public, Offering Investors Sky-High Potential—And Risk. Online: <https://www.forbes.com/sites/jeremybogaisky/2021/08/11/joby-stock-spac-nyse/?sh=20aace97a419>
- Booz Allen Hamilton. (2018, October 5). Executive Briefing Urban Air Mobility (UAM) Market Study.
- Booz Allen Hamilton. (2018). Urban Air Mobility Market Study. Online: <https://ntrs.nasa.gov/citations/20190001472>
- Bösch, P.M.; Becker, F.; Becker, H.; Axhausen, K.W. Cost-based analysis of autonomous mobility services. *Transp. Policy* 2018, 64.
- Borer et al. (2016). Design and Performance of the NASA SCEPTOR Distributed Electric Propulsion Flight Demonstrator. 16th AIAA Aviation Technology, Integration, and Operations Conference 13-17 June 2016 Washington, D.C. <https://doi.org/10.2514/6.2016-3920>

- Boston Consulting Group. (2014). Self-Driving Vehicles, Car Sharing, and the Urban Mobility Revolution. <https://www.bcg.com/en-us/industries/automotive/self-driving-vehicles-car-sharing>
- Browne, R. (2020, November 11). *German start-up Lilium snags Orlando deal to launch U.S. hub for flying taxis*. Retrieved from CNBC.com.
- Bucklin, R. E., Gupta, S., & Siddarth, S. (1998). Determining segmentation in sales response across consumer purchase behaviors. *Journal of Marketing Research*, 35(2), 189-197.
- Bureau of Transportation Statistics (BTS). (2021a). Top 25 Airports by Landed Weight of All Cargo Operations. Online: <https://www.bts.dot.gov/browse-statistical-products-and-data/freight-facts-and-figures/top-25-airports-landed-weight-all>
- Bureau of Transportation Statistics (BTS). (2021b). U.S. Ton-Miles of Freight. Online: <https://www.bts.gov/content/us-ton-miles-freight>
- Bureau of Transportation Statistics (BTS). (2021c). Average Freight Revenue per Ton-mile. <https://www.bts.gov/content/average-freight-revenue-ton-mile>
- Bureau of Transportation Statistics (BTS). (2021d). Number of U.S. Aircraft, Vehiclces, Vessels, and Other Conveyances. Online: <https://www.bts.gov/content/number-us-aircraft-vehicles-vessels-and-other-conveyances>
- Bureau of Transportation Statistics (BTS). (2011). *Household, Individual, and Vehicle Characteristics*. Online: [https://www.bts.gov/archive/publications/highlights\\_of\\_the\\_2001\\_national\\_household\\_travel\\_survey/section\\_01](https://www.bts.gov/archive/publications/highlights_of_the_2001_national_household_travel_survey/section_01)
- Canadian Air Mobility. (2020). *Advanced Air Mobility Comes to Vancouver*. Vancouver: White Paper.
- Canadian Air Mobility. (2020). *Economic Impacts of Advanced Air Mobility*. Vancouver: AAM White Paper Series Part 2.
- Canty, A. J. (2002). Resampling methods in R: the boot package. *The Newsletter of the R Project Volume*, 2(3), 2-7.
- Cavaignac, L., & Petiot, R. (2017). A quarter century of Data Envelopment Analysis applied to the transport sector: A bibliometric analysis. *Socio-Economic Planning Sciences*, 57, 84-96.
- Chaikalas, D., Khorrami, F. and Tzes, A. (2020). Adaptive Control Approaches for an Unmanned Aerial Manipulation System. *International Conference on Unmanned Aircraft Systems (ICUAS)*, Athens, Greece, 2020, pp. 498-503, doi: 10.1109/ICUAS48674.2020.9213920.
- Chappelle, C. et al. Opportunities to Enhance Air Emergency Medical Service Scale through New Vehicles and Operations. *Aviation Technology, Integration, and Operations Conference, Atlanta, Georgia, American Institute of Aeronautics and Astronautics, June 2018*.
- Chen, L., Wandelt, S., Dai, W., & Sun, X. (2022). Scalable Vertiport Hub Location Selection for Air Taxi Operations in a Metropolitan Region. *INFORMS Journal on Computing*, 34(2), 834-856.



- CityHawk EMS. (2022). *CityHawk EMS Product Page*. Retrieved May 22, 2022, from <https://www.urbanaero.com/ems>.
- Cobo, M. J., Chiclana, F., Collop, A., de Ona, J., & Herrera-Viedma, E. (2013). A bibliometric analysis of the intelligent transportation systems research based on science mapping. *IEEE transactions on intelligent transportation systems*, *15*(2), 901-908.
- Collins, M. P. (2017). *The Future Market for Large Unmanned Cargo Aircraft in the National Airspace System*. Lewis University.
- Cook, R. D. (1977). Detection of influential observation in linear regression. *Technometrics*, *19*(1), 15-18.
- Cooper, H. Organizing Knowledge Syntheses: A Taxonomy of Literature Reviews. *Knowledge in Society*, Vol. 1, 1988, pp. 104–126.
- Cotton, W. (2020). Adaptive Airborne Separation to Enable UAM Autonomy in Mixed Airspace. NASA/CR–2020-220438.
- Cotton, W. Adaptive Autonomous Separation for UAM in Mixed Operations. *Integrated Communications, Navigation and Surveillance Conference (ICNS)*, Herndon, VA, USA, 2019, pp. 1-11, doi: 10.1109/ICNSURV.2019.8735196.
- Cotton, W. (2018). Airborne Trajectory Management for Urban Air Mobility. American Institute of Aeronautics and Astronautics. June 2018. DOI: 10.2514/6.2018-3674
- Courtin, C. et al. (2018). Feasibility Study of Short Takeoff and Landing Urban Air Mobility Vehicles Using Geometric Programming. *MIT International Center For Air Transportation (ICAT) Department Of Aeronautics & Astronautics*.
- Courtin, C., Hansman, J. Drela, and M. Flight Test Results of a Subscale Super-STOL Aircraft. *2020 American Institute of Aeronautics and Astronautics (AIAA) Scitech forum*.
- Cowan, G. et al. (2022, Feb. 25). *Urban Aeronautics Study analyzes eVTOL operations in EMS response*. [evtol.com](https://evtol.com/features/urban-aeronautics-study-analyzes-evtol-operations-ems-response/). <https://evtol.com/features/urban-aeronautics-study-analyzes-evtol-operations-ems-response/>.
- Crown Consulting Inc. (2019). eVTOL Passenger Experience. Final Report.
- Crown Consulting Inc., Ascension Global, Georgia Tech Aerospace Systems Design Lab, McKinsey & Company, & NASA. (2018). Urban Air Mobility (UAM) Market Study. <https://ntrs.nasa.gov/api/citations/20190001190/downloads/20190001190.pdf>
- Crown Consulting Inc., Georgia Tech Aerospace Systems Design Laboratory, GRA Incorporated, LMI. NASA Automated Air Cargo Final Briefing. Increasingly Automated Air Cargo Operations Market Survey/Study
- Dahlberg, N. (2021a, Jun. 3). Joby’s deal with REEF could help bring air taxis to Miami as soon as 2024. <https://refreshmiami.com/jobys-deal-with-reef-could-help-bring-air-taxis-to-miami-as-soon-as-2024/>.
- Daskilewicz, M., German, B., Warren, M., Garrow, L. A., Boddupalli, S. S., & Douthat, T. H. (2018). Progress in vertiport placement and estimating aircraft range requirements for eVTOL daily commuting. In *2018 Aviation Technology, Integration, and Operations Conference* (p. 2884). <https://doi.org/10.2514/6.2018-2884>.

- Deane, S. (2022, Jan. 4). Key Private Jet Industry Statistics – By Region, By Country, By Type. <https://www.stratosjets.com/blog/private-jet-statistics/>.
- Del Rosario, R., Davis, T., Dymont, M., & Cohen, K. (2021). *Infrastructure To Support Advanced Autonomous Aircraft Technologies in Ohio: Economic Impact Report for Advanced Autonomous Aircraft Technologies in Ohio* (No. FHWA/OH-2021-18). Ohio. Department of Transportation. Office of Statewide Planning and Research.
- Dhalla, N. K., & Mahatoo, W. H. (1976). Expanding the Scope of Segmentation Research: Segmentation Research Must Cover More of the Total Marketing Problem if it is to be Operational and Profitable. *Journal of Marketing*, 40(2), 34-41.
- Diaz, P. and Yoon, S. A Physics-Based Approach to Urban Air Mobility. *European Rotorcraft Forum*. 2018.
- Diaz, P. and Yoon, S. High-Fidelity Computational Aerodynamics of Multi-Rotor Unmanned Aerial Vehicles. *AIAA SciTech Forum 2018, Kissimmee, Florida*.
- Eckstein, M., Jantos, T., Kelly, N., & Cardillo, A. (2002). Helicopter transport of pediatric trauma patients in an urban emergency medical services system: a critical analysis. *Journal of Trauma and Acute Care Surgery*, 53(2), 340-344.
- Einav, L., Leibtag, E. S., & Nevo, A. (2008). *On the accuracy of Nielsen Homescan data* (No. 1477-2016-121081).
- Erturk, C., et al. (2020). Requirements and Technologies Towards UAM: Communication, Navigation, and Surveillance. *arXiv:2004.12555v1 [eess.SP] 27 Apr 2020*
- Esqué, A. and Riedel, R. (2022). A milestone year for future air mobility. McKinsey & Company. Online: [https://www.mckinsey.com/industries/aerospace-and-defense/our-insights/future-air-mobility-blog/a-milestone-year-for-future-air-mobility?utm\\_source=Electric+VTOL+News&utm\\_campaign=81b3635aab-eVTOL+eNews%2C+Sept+29%2C+2017\\_COPY\\_01&utm\\_medium=email&utm\\_term=0\\_5d82db6e49-81b3635aab-50827190](https://www.mckinsey.com/industries/aerospace-and-defense/our-insights/future-air-mobility-blog/a-milestone-year-for-future-air-mobility?utm_source=Electric+VTOL+News&utm_campaign=81b3635aab-eVTOL+eNews%2C+Sept+29%2C+2017_COPY_01&utm_medium=email&utm_term=0_5d82db6e49-81b3635aab-50827190)
- EASA (2021). Study on the Societal Acceptance of Urban Air Mobility in Europe. Online: <https://www.easa.europa.eu/sites/default/files/dfu/uam-full-report.pdf>
- eVTOL. (2019). More than 200 eVTOL aircraft now in development. Online: <https://evtol.com/news/more-than-200-evtol-aircraft-now-in-development/>
- eVTOL. (2022). *US House passes bill that provides funding for AAM infrastructure*. Online: <https://evtol.com/news/us-house-passes-bill-funding-aam-infrastructure/>
- Federal Aviation Administration (FAA). (2018). Aircraft Operating Costs. Online: [https://www.faa.gov/regulations\\_policies/policy\\_guidance/benefit\\_cost/media/econ-value-section-4-op-costs.pdf](https://www.faa.gov/regulations_policies/policy_guidance/benefit_cost/media/econ-value-section-4-op-costs.pdf)
- Federal Aviation Administration (FAA). (2020a). *FAA Aerospace Forecast Fiscal Years 2020-2040*.
- Federal Aviation Administration . (2020b). *Urban Air Mobility and Advanced Air Mobility* . Retrieved from [faa.gov](https://www.faa.gov/uas/advanced_operations/urban_air_mobility/): [https://www.faa.gov/uas/advanced\\_operations/urban\\_air\\_mobility/](https://www.faa.gov/uas/advanced_operations/urban_air_mobility/)

- Federal Aviation Administration. (2020c). *Urban Air Mobility Concept of Operations*. Washington: Federal Aviation Administration.
- Federal Aviation Administration. (2020d). Passenger Boarding (Enplanement) and All-Cargo Data for U.S. Airports - Previous Years – Airports. Online: [https://www.faa.gov/airports/planning\\_capacity/passenger\\_allcargo\\_stats/passenger/previous\\_years/](https://www.faa.gov/airports/planning_capacity/passenger_allcargo_stats/passenger/previous_years/)
- Federal Aviation Administration (FAA). (2021a). *FAA Aerospace Forecast Fiscal Years 2021-2041*. Online: [https://www.faa.gov/data\\_research/aviation/aerospace\\_forecasts/media/FY2021-41\\_FAA\\_Aerospace\\_Forecast.pdf](https://www.faa.gov/data_research/aviation/aerospace_forecasts/media/FY2021-41_FAA_Aerospace_Forecast.pdf)
- Federal Aviation Administration (FAA). (2021b). *AIP Handbook – Office of Airports*. Online: [https://www.faa.gov/airports/aip/aip\\_handbook/?Chapter=4](https://www.faa.gov/airports/aip/aip_handbook/?Chapter=4)
- Federal Aviation Administration (FAA). (2022a, Jan. 25). General Aviation and Part 135 Activity Surveys - CY 2020. [https://www.faa.gov/data\\_research/aviation\\_data\\_statistics/general\\_aviation/cy2020](https://www.faa.gov/data_research/aviation_data_statistics/general_aviation/cy2020).
- Federal Aviation Administration (FAA). (2022b, Mar. 24). *FAA Aerospace Forecast 2021–2041*. [https://www.faa.gov/data\\_research/aviation/aerospace\\_forecasts](https://www.faa.gov/data_research/aviation/aerospace_forecasts).
- Federal Aviation Administration (FAA). (2022c, Jun. XX) *Engineering Brief No. 105, Vertiport Design*. [https://www.faa.gov/airports/engineering/engineering\\_briefs/drafts/media/eb-105-vertiport-design-industry-draft.pdf](https://www.faa.gov/airports/engineering/engineering_briefs/drafts/media/eb-105-vertiport-design-industry-draft.pdf)
- Federal Aviation Administration (FAA) & NASA (2020). *Urban Air Mobility: Concepts of Operations v1.0*. [https://nari.arc.nasa.gov/sites/default/files/attachments/UAM\\_ConOps\\_v1.0.pdf](https://nari.arc.nasa.gov/sites/default/files/attachments/UAM_ConOps_v1.0.pdf)
- Ferris, R. (2021) “Cars on American roads keep getting older.” CNBC. Online: <https://www.cnbc.com/2021/09/28/cars-on-american-roads-keep-getting-older.html>
- Fioravanti, R., Menezes, M., and Goentzel, J. (2009). Supply Chain Sensitivity to Macro Factors. <https://www.pomsmeetings.org/ConfPapers/011/011-0890.pdf>
- Forester, M. et al. Numerical modeling of solar wind influences on the dynamics of the high-latitude upper atmosphere. *Adv. Radio Sci.*, 10, 299–312, 2012 doi:10.5194/ars-10-299-2012
- France, S. L., & Ghose, S. (2019). Marketing analytics: Methods, practice, implementation, and links to other fields. *Expert Systems with Applications*, 119, 456-475.
- Fu, M., Rothfield, R., and Antoniou, C. (2019). Exploring Preferences for Transportation Modes in an Urban Air Mobility Environment: Munich Case Study. <https://doi.org/10.1177/0361198119843858>
- Fuse-Brown, E. C., Trish, E., Ly, B., Hall, M., & Adler, L. (2020). Out-of-Network Air Ambulance Bills: Prevalence, Magnitude, and Policy Solutions. *The Milbank Quarterly*, 98(3), 747-774.

- GAMA (2019). A Rational Construct for Simplified Vehicle Operations (SVO). Online: <https://nbaa.org/news/business-aviation-insider/2020-nov-dec/svo-path-toward-autonomous-aviation/>
- Garrow, L. A., Ilbeigi, M., and Chen, Z. (2017). Forecasting demand for on demand mobility. *17th AIAA Aviation Technology, Integration, and Operations Conference*.
- Garrow, L. A., Mokhtarian, P. L., German, B. J., & Boddupalli, S.-S. (2019). *Commuting in the Age of the Jetsons: A Market Segmentation Analysis of Autonomous Ground Vehicles and Air Taxis in Five Large U.S. Cities*. Atlanta : Georgia Institute of Technology.
- Gatto, K. (2011, May 20). *Eurocopter X3: The world's fastest copter*. <https://phys.org/news/2011-05-eurocopter-x3-world-fastest-copter.html>.
- Garrow, L. A., Roy, S., & Newman, J. P. (2020). Competition Among Traditional Modes, a Fully Autonomous Auto, and a Piloted Air Taxi for Commuting Trips in the US. *Working paper, Georgia Institute of Technology*.
- Geister D. and Korn B., Density based Management Concept for Urban Air Traffic, *IEEE/AIAA 37th Digital Avionics Systems Conference (DASC), London, UK, 2018, pp. 1-9, doi: 10.1109/DASC.2018.8569491*.
- German., B. and Daskilewicz., M. Aviation Global Demand Forecast Model Development and ISAAC Studies. *Georgia Institute of Technology*.
- Geuther, S., Francisco, C. Kirk, J. and Erhard, R. (2018). A VTOL Small Unmanned Aircraft System To Expand Payload Capabilities. *31<sup>st</sup> Congress of the International Council on Aeronautical Sciences*.
- Glaab, P. et al. (2019). Simulating Fleet Noise for Notional UAM Vehicles and Operations in New York. *NASA Langley Research Center Hampton, VA*.
- Global UTM Association. (2017). *UAS Traffic Management Architecture*. Global UTM Association.
- Golder, P. N., & Tellis, G. J. (2004). Growing, growing, gone: Cascades, diffusion, and turning points in the product life cycle. *Marketing Science*, 23(2), 207-218.
- Goodwin, P., & Wright, G. (2003). *Decision analysis for management judgment* (3rd ed.). John Wiley & Sons.
- Goyal, R., & Cohen, A. (2022). Advanced Air Mobility: Opportunities and Challenges Deploying eVTOLs for Air Ambulance Service. *Applied Sciences*, 12(3), 1183.
- Goyal, R.; Reiche, C.; Fernando, C.; Cohen, A. (2021). Advanced Air Mobility: Demand Analysis and Market Potential of the Airport Shuttle and Air Taxi Markets. *Sustainability* 2021, 13(13), 7421. <https://doi.org/10.3390/su13137421>
- Grand View Research. (2020). *Autonomous Vehicle Market Size, Share & Trends Analysis Report By Application (Transportation, Defense), By Region (North America, Europe, Asia Pacific, South America, MEA), And Segment Forecasts, 2021 – 2030*.
- Graydon, M., Neogi N., and Wasson K. Guidance for Designing Safety into Urban Air Mobility: Hazard Analysis Techniques. *AIAA Scitech Forum 6-10 January 2020. Orlando, FL* <https://doi.org/10.2514/6.2020-2099>.

- Grover, R., & Srinivasan, V. (1987). A simultaneous approach to market segmentation and market structuring. *Journal of Marketing Research*, 24(2), 139-153.
- Guerreiro, N., Hagen, G., Maddalon, J., and Butler, R. Capacity and Throughput of Urban Air Mobility Vertiports with a First-Come, First-Served Vertiport Scheduling Algorithm. AIAA Aviation 2020 Forum June 15-19, 2020 Virtual Event. <https://doi.org/10.2514/6.2020-2903>
- Gutu, L.M., Strachinaru, A.I., Strachinaru, A.V., and Ilie, V. The macroeconomic variables' impact on industrial production in the context of financial crisis. *Procedia Economics and Finance*, Vol. 32, 2015, pp. 1258 – 1267
- Guzzetti (2021, Feb. 27). The ABC's of UAM Infrastructure: If You Don't Build It, They Won't Come. <https://www.aerospacetechnology.com/the-abcs-of-uam-infrastructure-if-you-dont-build-it-they-wont-come-by-jeff-guzzetti/>.
- Guyot, K. and Sawhill, I.V. (2020). Telecommuting will likely continue long after the pandemic.
- Haan, J., Garrow, L., Marzouli, A., Roy, S., and Bierlaire, M. (2020). Are Commuter Air Taxis Coming to Your City? A Ranking of 40 Cities in the United States. The Center for Urban and Regional Air Mobility. Online: <http://garrowlab.ce.gatech.edu/sites/default/files/20201201%20TR-C%20city%20index%20Manuscript%20and%20Tables%20FINAL.pdf>
- Haddad, C., Chaniotakis, E., Straubinger, A., Plötner, K., Antoniou, C. Factors affecting the adoption and use of urban air mobility, Transportation Research Part A: Policy and Practice, Volume 132, 2020, pp. 696-712, ISSN 0965-8564, <https://doi.org/10.1016/j.tra.2019.12.020>.
- Hall, P. (1988). On symmetric bootstrap confidence intervals. *Journal of the Royal Statistical Society: Series B (Methodological)*, 50(1), 35-45.
- Hasan, S. (2019). Urban Air Mobility (UAM) Market Study. NASA. Online: <https://ntrs.nasa.gov/citations/20190002046>
- Head, E. (2021a). Joby touts a 10,000 flight cycle eVTOL battery. Can it deliver? Online: <https://evtol.com/features/joby-10000-flight-cycle-evtol-battery/>
- Head, E. (2021b, Apr. 13). Blade orders up to 20 eVTOL aircraft from Beta Technologies. <https://evtol.com/news/blade-orders-20-evtol-aircraft-from-beta-technologies/>.
- Head, E. (2021c, Aug. 24). Archer and REEF team up to transform parking garages into eVTOL vertiports. <https://evtol.com/news/archer-reef-parking-garages-evtol-vertiports/>.
- Hedges & Company. (2022). *US Vehicle Registration Statistics*. Online: <https://hedgescompany.com/automotive-market-research-statistics/auto-mailing-lists-and-marketing/>
- Henderson, D. A., & Denison, D. R. (1989). Stepwise regression in social and psychological research. *Psychological Reports*, 64(1), 251-257.

- Herniczek, M., Garbo, A., Lau, M., German, B. and Garrow, L. (2019). Exploration of Near-Term Urban Air Mobility Operations with Retrofitted Electric General Aviation Aircraft. *AIAA Aviation Forum. 17-21 June 2019. Dallas, Texas.* <https://doi.org/10.2514/6.2019-2872>
- Hill, B., DeCarme, D., Metcalfe, M., Griffin, C., Wiggins, S., Metts, C., Bastedo, B., Patterson, M., & Mendonca, N. (2020). UAM Vision Concept of Operations. 0–94. <https://ntrs.nasa.gov/citations/20205011091>
- Howell, C. and Shelton, K. The Nasa Urban Air Mobility Testbed Flight Research Aircraft. AUVSI Xponential Conference. 2019.
- Huber, M. (2019, June 26). *Boeing Partners with Kitty Hawk for Urban Air Mobility* . Retrieved from AIN Online: <https://www.ainonline.com/aviation-news/general-aviation/2019-06-26/boeing-partners-kitty-hawk-uam>
- Hunjra, A. I., Chani, M. I., Javed, S., Naeem, S., and Ijaz, M. S. (2014). Impact of Micro Economic Variables on Firms Performance. *International Journal of Economics and Empirical Research*, 2(2), 65-73.
- Huss, W. R. (1988). A move toward scenario analysis. *International Journal of Forecasting*, 4(3), 377-388.
- Hussain, A. and Silver D. (2021). Advanced Air Mobility: Can the United States Afford to Lose the Race? Deloitte Insights. Online: <https://www2.deloitte.com/us/en/insights/industry/aerospace-defense/advanced-air-mobility.html>
- International Air Transport Association (IATA). (2017). Air Cargo Data Sheet. <http://www.iata.org/whatwedo/cargo/sustainability/Documents/air-cargo-brochure.pdf>
- International Air Transport Association (IATA). (2020). Passenger Market Analysis. <https://www.iata.org/en/iata-repository/publications/economic-reports/airlines----dec-2019/>
- International Air Transport Association (IATA). (2021a). Air Cargo Market Analysis Strong air cargo growth continues. June, 2019–2022.
- International Air Transport Association (IATA). (2021b). IATA Economics’ Chart of the Week - 09 October 2020.
- International Air Transport Association (IATA). (2021c). Industry Statistics - April 2021. 1–2. <https://www.iata.org/en/iata-repository/pressroom/fact-sheets/industry-statistics/>
- International Air Transport Association (IATA). (2021d). Key to Air Cargo Resilience Post Pandemic: Cooperation, Safety, Sustainability, Modernization. Online: <https://www.iata.org/en/pressroom/2021-releases/2021-10-12-01/>
- International Air Transport Association (IATA). (2021e). World Air Transportation Statistics. Online: <https://www.iata.org/contentassets/a686ff624550453e8bf0c9b3f7f0ab26/wats-2021-mediakit.pdf>

- International Air Transport Association (IATA).(2022). Strong December Performance Contributes to Stellar Year for Air Cargo in 2021, Year-on-year Demand up 18.7% Online: <https://www.iata.org/en/pressroom/2022-releases/2022-25-01-01/>
- Ilmakunnas P. and Topi., J. (1999). Microeconomic and Macroeconomic Influences on Entry and Exit of Firms. *Review of Industrial Organization* 15: 283–301.
- Imanberdiyev, N., Monica, J., and Kayacan, E. (2019). A Multi-Task Velocity-Based Redundancy Resolution Strategy for Unmanned Aerial Manipulators. *18th European Control Conference (ECC), Naples, Italy, 2019, pp. 1130-1135, doi: 10.23919/ECC.2019.8796272.*
- Ji., B., Zenggang, L., Chen, S., and Zhu, Q. (2020) Aerodynamic Analysis of a Flapping Wing Aircraft for Short Landing. *Applied Sciences*. DOI: 10.3390/app10103404
- Jia, Z. and Lee, S. Aeroacoustic Analysis of a Side-by-Side Hybrid VTOL Aircraft. *Vertical Flight Society 76th Annual Forum & Technology Display, Virginia Beach, Virginia, October 6-8, 2020.*
- Jia, Z. and Lee, S. Acoustic Analysis of Urban Air Mobility Quadrotor Aircraft. *Advanced Vertical Flight Technical Meeting, San Jose, California, Jan. 21–23, 2020.*
- Joby (2021). Analyst Day Presentation. Online: [https://d1io3yog0oux5.cloudfront.net/\\_6e9f9701a0a46f43e4345e6632376fc6/jobyaviation/db/1086/9729/pdf/Joby+Aviation\\_Analyst+Day+Presentation.pdf](https://d1io3yog0oux5.cloudfront.net/_6e9f9701a0a46f43e4345e6632376fc6/jobyaviation/db/1086/9729/pdf/Joby+Aviation_Analyst+Day+Presentation.pdf)
- Joby (2022). Press Releases. Online: <https://ir.jobyaviation.com/news-events/press-releases>
- Joby (2022b, May 26). Joby Receives Part 135 Certificate From the FAA. Retrieved November 10, 2022, from <https://www.jobyaviation.com/news/joby-receives-part-135-air-carrier-certificate/>
- Johnson, W. (2020). A Quiet Helicopter for Air Taxi Operations. *NASA Ames Research Center.*
- Johnson, W. and Silva, C. (2018) Observations from Exploration of VTOL Urban Air Mobility Designs. *NASA.*
- Kadam, S., Bandyopadhyay, P. K., & Patil, Y. (2016). Mapping the field through bibliometric analysis of passenger centric railway transportation. *International Journal of Automation and Logistics*, 2(4), 349-368.
- Kang, D., & Park, Y. (2019). Analysing diffusion pattern of mobile application services in Korea using the competitive Bass model and Herfindahl index. *Applied Economics Letters*, 26(3), 222-230.
- Kauffman, R. J., McAndrews, J., & Wang, Y. (2000). Opening the “Black box” of network externalities in network adoption. *Information Systems Research*, 11(1), 61-82.
- KBV Research. (2021, May 26). *Global Air Ambulance Services market by type, by model, by Regional Outlook, industry analysis report and forecast, 2021 - 2027*. GlobeNewswire News Room. Retrieved April 4, 2022, from <https://www.kbvresearch.com/air-ambulance-services-market/>.

- Keeler, J., Verma, S., and Edwards, T. Investigation of Communications Involved in Near-term UAM Operations. *IEEE/AIAA 38th Digital Avionics Systems Conference (DASC)*, San Diego, CA, USA, 2019, pp. 1-10, doi: 10.1109/DASC43569.2019.9081682.
- Kim, S. Receding Horizon Scheduling of On-Demand Urban Air Mobility With Heterogeneous Fleet. *IEEE Transactions on Aerospace and Electronic Systems*, vol. 56, no. 4, pp. 2751-2761, Aug. 2020, doi: 10.1109/TAES.2019.2953417.
- Kleinbekman, I., Mitici, M., & Wei, P. eVTOL Arrival Sequencing and Scheduling for On-Demand Urban Air Mobility. (2018). *IEEE/AIAA 37th Digital Avionics Systems Conference (DASC)*, London, UK, 2018, pp. 1-7, doi: 10.1109/DASC.2018.8569645.
- Kloss, B., & Riedel, R. (2021, Jun. 1). Up in the air: How do consumers view advanced air mobility? <https://www.mckinsey.com/industries/aerospace-and-defense/our-insights/up-in-the-air-how-do-consumers-view-advanced-air-mobility>.
- Kohlman, L., Patterson, M., and Raabe, B. (2019). Urban Air Mobility Network and Vehicle Type—Modeling and Assessment. *NASA/TM—2019–220072*.
- Kotabe, M. M., & Helsen, K. (2020). *Global marketing management (8<sup>th</sup> edition)*. John Wiley & Sons.
- Kulisch, E. (2021). Why is air cargo suddenly affordable relative to ocean shipping? Online: <https://www.freightwaves.com/news/why-is-air-cargo-suddenly-more-affordable-compared-to-ocean-shipping>
- Kumar, D., & Klefsjö, B. (1994). Proportional hazards model: A review. *Reliability Engineering & System Safety*, 44(2), 177-188.
- Kumar, Y. (2020) Blade to Go Public Via SPAC at \$825. *Helicopter Investor*. Online: <https://www.helicopterinvestor.com/articles/blade-to-go-public-via-spac-at-825m-111/>
- Kunchulia, A., Edwards, T., Hasan, S. and Price, G. Urban Air Mobility Minimum Viable Product. *AIAA Aviation Forum 17-21 June 2019, Dallas, Texas*. <https://doi.org/10.2514/6.2019-2874>
- Kyurkchiev, N., & Iliev, A. (2018). *Extension of Gompertz-type Equation in Modern Science: 240 Anniversary of the birth of B. Gompertz*. Deutschland: LAP Lambert Academic Publishing.
- Larson, J. T., Dietrich, A. M., Abdessalam, S. F., & Werman, H. A. (2004). Effective use of the air ambulance for pediatric trauma. *Journal of Trauma and Acute Care Surgery*, 56(1), 89-93.
- Lascara, B., Spencer, T., DeGarmo, M., Lacher, A., Maroney, D., & Guterres, M. (2018). Urban Air Mobility Landscape Report: Initial Examination of a New Air Transportation System. <https://www.mitre.org/publications/technical-papers/urban-air-mobility-landscape-report>
- Leung, A., Burke, M., Cui, J., & Perl, A. (2019). Fuel price changes and their impacts on urban transport—a literature review using bibliometric and content analysis techniques, 1972–2017. *Transport Reviews*, 39(4), 463-484.



- Liebeck, R.H.; Andrastek, D.A.; Chau, J.; Girvin, R.; Lyon, R.; Rawdon, B. K.; Scott, P.W.; Wright, R.A. Advanced Subsonic Airplane Design and Economic Studies NASA CR-195443; McDonnell Douglas Aerospace: Long Beach, CA, USA, 1995.
- Lies, W., Narula, L., Iannucci, P., and Humphreys, T. Low SWaP-C Radar for Urban Air Mobility. (2020). *IEEE/ION Position, Location and Navigation Symposium (PLANS), Portland, OR, USA, 2020*, pp. 74-80, doi: 10.1109/PLANS46316.2020.9110148.
- Lin, S. et al. (2019). Development of an Autonomous Unmanned Aerial Manipulator Based on a Real-Time Oriented-Object Detection Method. *Sensors*. 2019, 19, 2396; doi:10.3390/s19102396
- Littell, J. H., Corcoran, J., & Pillai, V. (2008). *Systematic reviews and meta-analysis*. Oxford University Press.
- Litman, T. Autonomous Vehicle Implementation Predictions—Implications for Transport Planning; Victoria Transport Policy Institute: Victoria, BC, Canada, 2020.
- Locascio, et al. (2016). Evaluation of Concepts of Operations for sUAS Package Delivery. 16th *AIAA Aviation Technology, Integration, and Operations Conference 13-17 June 2016, Washington, D.C.* <https://doi.org/10.2514/6.2016-4371>
- Lombaerts T. et al. (2020). Control Concepts for Simplified Vehicle Operations of a Quadrotor eVTOL Vehicle. *AIAA Aviation Conference, 15–19 June 2020*.
- Lombaerts, T., et al. (2020) Dynamic Inversion based Full Envelope Flight Control for an eVTOL Vehicle using a Unified Framework. *AIAA SciTech Forum, Orlando, FL, 6–10 January 2020*.
- Loucks D.P., van Beek E. (2017). System Sensitivity and Uncertainty Analysis. In: *Water Resource Systems Planning and Management*. Springer, Cham. [https://doi.org/10.1007/978-3-319-44234-1\\_8](https://doi.org/10.1007/978-3-319-44234-1_8)
- MacInnis, D. J., & Jaworski, B. J. (1989). Information processing from advertisements: Toward an integrative framework. *Journal of Marketing*, 53(4), 1-23.
- Mahajan, V., Muller, E., & Bass, F. M. (1990). New product diffusion models in marketing: A review and directions for research. *Journal of Marketing*, 54(1), 1-26.
- Mahajan, V., Sharma, S., & Buzzell, R. D. (1993). Assessing the impact of competitive entry on market expansion and incumbent sales. *Journal of Marketing*, 57(3), 39-52.
- Malpica, C. and Withrow-Maser, S. Handling Qualities Analysis of Blade Pitch and Rotor Speed Controlled eVTOL Quadrotor Concepts for Urban Air Mobility. *VFS International Powered Lift Conference, San Jose, CA, January 21–23, 2020*.
- Manfred Hader. (2019). *MAPPING AUTONOMOUS URBAN AIR Mobility's Progress*. Hamburg: Roland Berger.
- Mathur, A. Panesar, K., Kim, J. Atkins, E. and Sarter, N. (2019). Paths to Autonomous Vehicle Operations for Urban Air Mobility. *AIAA Aviation 2019 Forum 17-21 June 2019, Dallas, Texas*, <https://doi.org/10.2514/6.2019-3255>

- Mayakonda, M., Justin, C. Y., Anand, A., Weit, C. J., Wen, J., Zaidi, T., & Mavris, D. (2020). A Top-Down Methodology for Global Urban Air Mobility Demand Estimation. In *AIAA AVIATION 2020 FORUM* (p. 3255).
- Mayor, T. and Anderson, J. (2020). Getting Mobility Off the Ground. *KPGMG*.  
<https://assets.kpmg/content/dam/kpmg/ie/pdf/2019/10/ie-urban-air-mobility.pdf>
- Moore, K. G. (2012). *High-Speed Mobility through On-Demand Aviation*. Langley: American Institute of Aeronautics and Astronautics.
- Mordor Intelligence (2021). Urban Air Mobility Market: Growth, Trends, COVID-19 Impact and Forecasts (2021-2035). Online: <https://www.mordorintelligence.com/industry-reports/urban-air-mobility-uam-market>
- McKinsey & Company. (2021). The coronavirus effect on global economic sentiment. October 2021. Online: <https://www.mckinsey.com/business-functions/strategy-and-corporate-finance/our-insights/the-coronavirus-effect-on-global-economic-sentiment>
- McKinsey & Company. (2021). How COVID-19 is Reshaping Supply Chains. Online: <https://www.mckinsey.com/business-functions/operations/our-insights/how-covid-19-is-reshaping-supply-chains>
- McKinsey & Company (2021, May 26). *Up in the air: How do consumers view advanced air mobility?* <https://www.mckinsey.com/industries/aerospace-and-defense/our-insights/up-in-the-air-how-do-consumers-view-advanced-air-mobility>.
- Military Factory (2021, Feb. 16). Airbus Helicopters H160 (X4).  
[https://www.militaryfactory.com/aircraft/detail.php?aircraft\\_id=1342](https://www.militaryfactory.com/aircraft/detail.php?aircraft_id=1342).
- Minaya, E. (2020). CFOs Plan To Permanently Shift Significant Numbers Of Employees To Work Remotely — Survey.  
<https://www.forbes.com/sites/ezequielminaya/2020/04/03/cfos-plan-to-permanently-shift-significant-numbers-of-employees-to-work-remotely---survey/?sh=15f917f7575b>
- Modak, N. M., Merigó, J. M., Weber, R., Manzor, F., & de Dios Ortúzar, J. (2019). Fifty years of Transportation Research journals: A bibliometric overview. *Transportation Research Part A: Policy and Practice*, 120, 188-223.
- Morgan Stanley. (2018). *Flying Cars: Investment Implications of Autonomous Urban Air Mobility*. Alphawise.
- Mongeon, P., & Paul-Hus, A. (2016). The journal coverage of Web of Science and Scopus: a comparative analysis. *Scientometrics*, 106(1), 213-228.
- Nanalyze. (2002, Mar. 10). *Blade Air Mobility Stock and Urban Air Mobility*.  
<https://www.nanalyze.com/2022/03/blade-air-mobility-stock/>.
- NASA. (2012). NASA Advanced Air Mobility (AAM) Project Vertiport Terminology Discussion. *RTT* (p. 12). Langley: NASA.
- NASA (2018). *Urban Air Mobility (UAM) Market Study*. Crown Consulting, Acension Global, GeorgiaTech Aerospace Systems Design Lab, McKinsey & Company. Langley: NASA.
- NASA (2021a). Community Annex Teams. For Internal Use Only.

- NASA. (2021b, Apr. 20). Regional Air Mobility: Leveraging Our National Investments to Energize the American Travel Experience. <https://sacd.larc.nasa.gov/sacd/wp-content/uploads/sites/102/2021/04/2021-04-20-RAM.pdf>
- NASA (2021c, May 27). *High-Density Automated Vertiport Concept of Operations*. <https://ntrs.nasa.gov/citations/20210016168>.
- NEXA, LLC. (2012). *Air Traffic Infrastructure Global Markets 2012*. Washington : NEXA, LLC.
- NEXA, LLC. (2019). *Urban Air Mobility Economics and Global Markets*. McLean: NEXA, LLC.
- Nicholl, J. P., Beeby, N. R., & Brazier, J. E. (1994). A comparison of the costs and performance of an emergency helicopter and land ambulances in a rural area. *Injury*, 25(3), 145-153.
- Niklafs, M., et al. (2020). A Collaborative Approach for an Integrated Modeling of Urban Air Transportation Systems. *Aerospace*.
- O'Connor et al. (2018). Development of a simulation platform to evaluate integration of UAM traffic into the NAS. AIAA AVIATION Forum, June 25-29, 2018, Atlanta, Georgia.
- Parker, M. (2021, Oct. 1). *Lilium, current and potential mayors answer questions on air taxis*. <https://stpetecatalyst.com/lilium-current-and-potential-mayors-answer-questions-on-air-taxis/>.
- Patterson, M.D. et al. (2021). An Initial Concept for Intermediate-State, Passenger-Carrying Urban Air Mobility Operations. *AIAA Scitech 2021 Forum 11–15 & 19–21 January 2021*. <https://doi.org/10.2514/6.2021-1626>.
- Patterson, M.D.; Antcliff, K.R.; Kohlman, L.W. A Proposed Approach to Studying Urban Air Mobility Missions Including an Initial Exploration of Mission Requirements. In Proceedings of the 75th Annual Forum and Technology Display, Phoenix, AZ, USA, 14–17 May 2018.
- Ploetner, K.O.; Al Haddad, C.; Antoniou, C.; Frank, F.; Fu, M.; Kabel, S.; Llorca, C.; Moeckel, R.; Moreno, A.T.; Pukhova, A.; et al. Long-term application potential of urban air mobility complementing public transport: An upper Bavaria example. In Proceedings of the Deutscher Luft- und Raumfahrtkongress, Darmstadt, Germany, 30 September–2 October 2019.
- Pongsakornsathien, N., et al. (2020). A Performance-Based Airspace Model for Unmanned Aircraft Systems Traffic Management. *Aerospace*.
- Postma, T. J., & Liebl, F. (2005). How to improve scenario analysis as a strategic management tool?. *Technological Forecasting and Social Change*, 72(2), 161-173.
- Postorino, M. and Sarne, G. Reinventing Mobility Paradigms: Flying Car Scenarios and Challenges for Urban Mobility. *Sustainability* 2020, 12, 3581; [doi:10.3390/su12093581](https://doi.org/10.3390/su12093581)
- Porsche Consulting. (n.d.). *The Future of Vertical Mobility Sizing the Market for Passenger, Inspection, and Goods and Services Until 2035*. Porsche Consulting
- Pradeep, P. and Wei, P. (2019) Energy Efficient Arrival with RTA Constraint for Urban eVTOL Operations. *Aerospace Research Central*. <https://doi.org/10.2514/1.I010710>.

- Pradeep, P. and Wei, P. Energy Optimal Speed Profile for Arrival of Tandem Tilt-Wing eVTOL Aircraft with RTA Constraint. *IEEE CSAA Guidance, Navigation and Control Conference (CGNCC), Xiamen, China, 2018*, pp. 1-6, doi: 10.1109/GNCC42960.2018.9018748.
- Pradeep, P. and Wei, P. Heuristic Approach for Arrival Sequencing and Scheduling for eVTOL Aircraft in On-Demand Urban Air Mobility. *IEEE/AIAA 37th Digital Avionics Systems Conference (DASC), London, UK, 2018*, pp. 1-7, doi: 10.1109/DASC.2018.8569225.
- Precedence Research. (2022, Feb 4). *Ambulance Services Market (By Transport Vehicle: Ground Ambulance, Air Ambulance, Water Ambulance; By Services: Emergency Services and Non-emergency Services; By Equipment: Advance Life Support Ambulance Services (ALS) and Basic Life Support Ambulance Services (BLS)) - Global Industry Analysis, Size, Share, Growth, Trends, Regional Outlook, and Forecast 2021 – 2030*. <https://www.precedenceresearch.com/ambulance-services-market>.
- Price, G. and Helton, D. Urban Air Mobility Operational Concept (OpsCon) Passenger-Carrying Operations. *Crown Consulting. NASA/CR—2020–5001587*
- Punj, G., & Stewart, D. W. (1983). Cluster analysis in marketing research: Review and suggestions for application. *Journal of Marketing Research*, 20(2), 134-148.
- Purcell, E. M. (1985). The Back of the Envelope. *American Journal of Physics*, 53(7), 615-615.
- Pyo, J. and Yu, S. Development of Radial Layout Underwater Acoustic Marker Using Forward Scan Sonar for AUV. *IEEE Underwater Technology (UT), Kaohsiung, Taiwan, 2019*, pp. 1-6, doi: 10.1109/UT.2019.8734324.
- Radojičić, V. D., & Marković, G. Z. (2009, October). New technology forecasting using the bass model. In *2009 9th International Conference on Telecommunication in Modern Satellite, Cable, and Broadcasting Services* (pp. 277-280). IEEE.
- Rajendran, S. Recommendations for emerging air taxi network operations based on online review analysis of helicopter services. *Heliyon. Volume 6, Issue 12, December 2020*, e05581
- Ramos, E., Dien, S., Gonzales, A., Chavez, M., & Hazen, B. (2020). Supply chain cost research: a bibliometric mapping perspective. *Benchmarking: An International Journal*, In Press.
- Ratcliff, R., & Doshi, K. (2016). Using the Bass Model to Analyze the Diffusion of Innovations at the Base of the Pyramid. *Business & Society*, 55(2), 271-298.
- Reiche, C., Goyal, R., Cohen, A., Serrao, J., Kimmel, S., Fernando, C., & Shaheen, S. (2018). Urban air mobility market study. Booz Allen Hamilton. <https://escholarship.org/content/qt0fz0x1s2/qt0fz0x1s2.pdf>.
- Reiche C., McGillen, C., Siegel J., and F. Brody. Are We Ready to Weather Urban Air Mobility (UAM)? (2019). *Integrated Communications, Navigation and Surveillance Conference (ICNS), Herndon, VA, USA, 2019*, pp. 1-7, doi: 10.1109/ICNSURV.2019.8735297.

- Reichmann, K. (2021). *What role could air taxis play in emergency response?* October/November 2021 - What Role Could Air Taxis Play in Emergency Response? | Avionics Digital Edition. Retrieved April 4, 2022, from <http://interactive.aviationtoday.com/avionicsmagazine/october-november-2021/what-role-could-air-taxis-play-in-emergency-response/>.
- Research and Markets. (2021a, October 27). *United States Urban Air Mobility (UAM) markets to 2035 - increasing demand for air ambulance vehicles & growing need for an alternate mode of transportation in urban mobility. United States Urban Air Mobility (UAM) Markets to 2035 - Increasing Demand for Air Ambulance Vehicles & Growing Need for an Alternate Mode of Transportation in Urban Mobility.* <https://www.prnewswire.com/news-releases/united-states-urban-air-mobility-uam-markets-to-2035---increasing-demand-for-air-ambulance-vehicles--growing-need-for-an-alternate-mode-of-transportation-in-urban-mobility-301409739.html>.
- Research and Markets. (2021b, December 22). *Worldwide Urban Air Mobility Market (2021 to 2025) - north america and Europe to be at the forefront of the UAM Revolution.* GlobeNewswire News Room. <https://www.globenewswire.com/news-release/2021/12/22/2356700/28124/en/Worldwide-Urban-Air-Mobility-Market-2021-to-2025-North-America-and-Europe-to-be-at-the-Forefront-of-the-UAM-Revolution.html>
- Rhinehart, Z. J., Guyette, F. X., Sperry, J. L., Forsythe, R. M., Murdock, A., Alarcon, L. H., ... & Rosengart, M. R. (2013). The association between air ambulance distribution and trauma mortality. *Annals of Surgery*, 257(6), 1147-1153.
- Rimjha, M. L. (2018). On Demand Mobility Cargo Demand Estimation. *Virginia Polytechnic Institute and State University*.
- Rimjha, M. L. (2020). *Demand Forecast Model Development And Scenarios Generation For Urban Air Mobility Concepts*. Langley: Virginia Tech Air Transportation Systems Laboratory.
- Rimjha, M., Hotle, S., Trani, A., & Hinze, N. (2021). Commuter demand estimation and feasibility assessment for Urban Air Mobility in Northern California. *Transportation Research Part A: Policy and Practice*, 148, 506-524.
- Rimjha, M., Tarafdar, S., Hinze, N., Trani, A. A., Swingle, H., Smith, J. C., ... & Dollyhigh, S. (2020, September). On-Demand Mobility Cargo Demand Estimation in Northern California Region. In *2020 Integrated Communications Navigation and Surveillance Conference (ICNS)* (pp. 6A2-1). IEEE. <https://doi.org/10.1016/j.tra.2021.03.020>.
- Rimjha, M., & Trani, A. (2021, April). Urban Air Mobility: Factors Affecting Vertiport Capacity. In *2021 Integrated Communications Navigation and Surveillance Conference (ICNS)* (pp. 1-14). IEEE.
- Robinson, J., Sokellek, M., Justin, C., and Mavris, D. (2018). Development of a Methodology for Parametric Analysis of STOL Airpark Geo-Density. *Georgia Institute of Technology*. DOI: 10.2514/6.2018-3054
- Roland Berger . (n.d.). *Focus Urban Air Mobility* . Roland Berger.
- Roland Berger. (2018). *Urban Air Mobility The rise of a new mode of transportation*. Roland Berger.

- Rothfield, R. et al. (2018). Agent-based Simulation of Urban Air Mobility. *Modeling and Simulation Technologies Conference. June 25-29, 2018. Atlanta, Georgia*  
<https://doi.org/10.2514/6.2018-3891>
- Rothfeld, R., Balac, M., Ploetner K., and Antoniou C. Initial Analysis of Urban Air Mobility's Transport Performance in Sioux Falls. *Aviation Technology, Integration, and Operations Conference. June 25-29, 2018 Atlanta, Georgia* <https://doi.org/10.2514/6.2018-2886>
- Rothfeld, R., Straubinger, A., Fu, M., Al Haddad, C., & Antoniou, C. (2020). Urban air mobility. In *Demand for Emerging Transportation Systems* (pp. 267–284). Elsevier.  
<https://doi.org/10.1016/B978-0-12-815018-4.00013-9>
- Roy, S., HERNICZEK, M. T., & GERMAN, B. J. (2020). *User Base Estimation Methodology for an eVTOL Business Airport Shuttle Air Taxi Service*. Atlanta : Georgia Institute of Technology .
- Roy, S., HERNICZEK, M. T., LEONARD, C., JHA, A., WANG, N. J., GERMAN, B. J., & GARROW, L. A. (2020). *A Multi-Commodity Network Flow Approach for Optimal Flight Scheduling of an Airport Shuttle Air Taxi Service*. Atlanta : Georgia Institute of Technology.
- Roy, S., Maheshwari, A., Crossley, W. A., & DeLaurentis, D. A. (2018). *A Study on the Impact of Aircraft Technology on the Future of Regional Transportation Using Small Aircraft*. West Lafayette : Purdue University.
- Roy, S., Maheshwari, A., Crossley, W. A., & DeLaurentis, D. A. (2019). *A study to investigate total mobility using both CTOL and VTOL-capable aircraft*. West Lafayette: Purdue University.
- Rozenberg, R. et al. (2021). Information Model for Evaluation and Selection of Instructor Pilots for Smart City Urban Air Mobility.
- Salas, E. (2020). *Number of public and private airports in the United States as of February 2020, by type of facility*. <https://www.statista.com/statistics/676860/number-of-airports-in-the-united-states-by-type-of-facility/#:~:text=As%20of%20February%202020%2C%20there,a%20landing%20place%20for%20helicopters.>
- Salmerón, R., García, C. B., & García, J. (2018). Variance inflation factor and condition number in multiple linear regression. *Journal of Statistical Computation and Simulation*, 88(12), 2365-2384.
- Santha, N. (2020). The impact of COVID-19 on the eVTOL industry. *Australian Aviation*.  
[https://www.lek.com/sites/default/files/published\\_articles/LEK-AA\\_EVTOL.pdf](https://www.lek.com/sites/default/files/published_articles/LEK-AA_EVTOL.pdf)
- Satadru Roy, A. M. (2019). *A study to investigate total mobility using both CTOL and VTOL-capable aircraft*. Dallas: AIAA Aviation Forum.
- Satoh, D. (2001). A discrete Bass model and its parameter estimation. *Journal of the Operations Research Society of Japan*, 44(1), 1-18.
- Schaer, O., & Kourentzes, N. (2018, Jan. 5). *diffusion: Forecast the Diffusion of New Products*.  
<https://cran.r-project.org/web/packages/diffusion/index.html>.

- Seol, H., Park, G., Lee, H., & Yoon, B. (2012). Demand forecasting for new media services with consideration of competitive relationships using the competitive Bass model and the theory of the niche. *Technological Forecasting and Social Change*, 79(7), 1217-1228.
- Shao, Q., Shao, M., & Lu, Y. (2021). Terminal area control rules and eVTOL adaptive scheduling model for multi-vertiport system in urban air Mobility. *Transportation Research Part C: Emerging Technologies*, 132, 103385.
- Shihab, S. and Wei, P. Optimal eVTOL Fleet Dispatch for Urban Air Mobility and Power Grid Services. *AIAA Aviation Forum. June 15-19, 2020* <https://doi.org/10.2514/6.2020-2906>
- Siewert, S. et. al. (2020). Comparison of RADAR, Passive Optical with Acoustic, and Fused Multi-Modal Active and Passive Sensing for UAS Traffic Management Compliance and Urban Air Mobility Safety. *Embry Riddle Aeronautical University*.
- Siewert, S., Sampigethaya, K., Buchholz J., and Rizor, S. Fail-Safe, Fail-Secure Experiments for Small UAS and UAM Traffic in Urban Airspace. *IEEE/AIAA 38th Digital Avionics Systems Conference (DASC), San Diego, CA, USA, 2019, pp. 1-7, doi: 10.1109/DASC43569.2019.9081710*.
- Sison, B. (2017). *Man recovers from heart attack, receives \$39,000 helicopter bill: 'We worry about bankruptcy'*. <https://www.wtvr.com/2019/12/17/man-recovers-from-heart-attack-receives-39000-helicopter-bill-we-worry-about-bankruptcy>.
- Somers, L., Justin, C. and Mavris, D. Wind and Obstacles Impact on Airpark Placement for STOL-based Sub-Urban Air Mobility. *AIAA Aviation Forum. 17-21 June 2019. Dallas, Texas* <https://doi.org/10.2514/6.2019-3121>
- Skuhersky, M. A First-Principle Power and Energy Model for eVTOL Vehicles. *Florida Institute of Technology*. 2019.
- SMG Consulting. (2021). "AAM Reality Index: The Much Awaited December Chart." Online: <https://www.urbanairmobilitynews.com/air-taxis/smg-consulting-aam-reality-index-the-much-awaited-december-chart/>
- SMG Consulting. (2022). AAM Reality Index. <https://aamrealityindex.com/>
- Smith, W. R. (1956). Product differentiation and market segmentation as alternative marketing strategies. *Journal of Marketing*, 21(1), 3-8.
- Song, K., Yeo, H., & Moon, J. H. (2021). Approach Control Concepts and Optimal Vertiport Airspace Design for Urban Air Mobility (UAM) Operation. *International Journal of Aeronautical and Space Sciences*, 22(4), 982-994.
- Sood, A., James, G. M., Tellis, G. J., & Zhu, J. (2012). Predicting the path of technological innovation: SAW vs. Moore, Bass, Gompertz, and Kryder. *Marketing Science*, 31(6), 964-979.
- Sporrer, Alyssa. (2021). Ocean delays turn desperate retailers to the skies, increasing emissions. Online: <https://www.freightwaves.com/news/ocean-delays-turn-desperate-retailers-to-the-skies-increasing-emissions#:~:text=Shippers%20are%20shifting%20cargo%20from,than%20moving%20it%20via%20aircraft.>

- Starry, C., & Bernstein, G. W. (2008). The economics of private business jet travel. *Business Economics*, 43(4), 36-44.
- Stith, P. et al. (n.d.) Powered for Takeoff. *Black & Veatch. NIA-NASA Urban Air Mobility Electric Infrastructure Study*.
- Stith, P., & Khangura, J. (2020). *Preparing for Take-Off: Urban Air Mobility Infrastructure National Institute of Aerospace (NIA) National Aeronautics and Space Administration (NASA) Stud Results*. Portland : 33rd Electric Vehicle Symposium .
- Stoll, A. and Mikic, G. (2016). Design Studies of Thin-Haul Commuter Aircraft with Distributed Electric Propulsion. *16th AIAA Aviation Technology, Integration, and Operations Conference 13-17 June 2016 Washington, D.C. <https://doi.org/10.2514/6.2016-3765>*
- Stouffer, V., et al. (2020). Reliable, Secure, and Scalable Communications, Navigation, and Surveillance (CNS) Options for Urban Air Mobility (UAM). Science Applications International Corporation.
- Straubinger, A., Rothfeld, R., Shamiyeh, M., Büchter, K.-D., Kaiser, J., & Plotner, K. O. (2020). *An overview of current research and developments in urban air mobility Setting the scene for UAM introduction*. Journal of Air Transport Management.
- Syed, et al. (2017). On Demand Mobility Commuter Aircraft Demand Estimation. *Virginia Polytechnic Institute and State University*.
- Katz, S. et al. (2019). Learning an Urban Air Mobility Encounter Model from Expert Preferences. *Cornell University*.
- Tarafdar, S., Rimjha, M., Hinze, N., Hotle, S. and Trani., A. Urban air Mobility Regional Landing Site Feasibility and Fare Model Analysis in the Greater Northern California Region. *Integrated Communications, Navigation and Surveillance Conference (ICNS), Herndon, VA, USA, 2019, pp. 1-11, doi: 10.1109/ICNSURV.2019.8735267*.
- Taylor, M. J. H. T. (Ed.). (1999). *Brassey's World Aircraft & Systems Directory, 1999/2000*. Brassey's.
- Taylor, M., Flenniken, L., Nembhard J., and Barreal, A. Design of a Rapid, Reliable Urban Mobility System for the DC Region, *Integrated Communications Navigation and Surveillance Conference (ICNS), Herndon, VA, USA, 2020, pp. 2A1-1-2A1-11, doi: 10.1109/ICNS50378.2020.9222887*.
- Taylor, M., Saldanli, A., and Park, A. Design of a Vertiport Design Tool. *Proceedings of the 2020 Annual General Donald R. Keith Memorial Capstone Conference*. West Point, New York, USA
- Thal, A., Roget, B., Sitaramann, J., and Grace, S. Multirotor Trim using Loose Aerodynamic Coupling. *VFS Aeromechanics for Advanced Vertical Flight Technical Meeting. San Jose, CA, January 2020*.
- The Community Air Mobility Initiative. (2020). *Community Benefits of Urban Air Mobility* . The Community Air Mobility Initiative.
- The Community Air Mobility Initiative. (2020). *Components of Public Acceptance for AAM & UAM*. The Community Air Mobility Initiative.



- The Community Air Mobility Initiative. (2020). *eVTOL Aircraft, What They Are And Why They Matter*. The Community Air Mobility Initiative.
- The Community Air Mobility Initiative. (2020). *Legal Considerations for Urban Air Mobility Part I: Aviation Law*. The Community Air Mobility Initiative.
- The Community Air Mobility Initiative. (2020). *Supporting the responsible integration of the third dimension at the state and local level*. The Community Air Mobility Initiative.
- The Community Air Mobility Initiative. (2020). *Urban Air Mobility Overview*. The Community Air Mobility Initiative.
- The Community Air Mobility Initiative. (2020). *What is Urban Air Mobility*. The Community Air Mobility Initiative.
- The National Academies of Sciences Engineering Medicine. (2020). *Advancing Aerial Mobility: A National Blueprint*. Washington : The National Academies Press.
- Thippavong, D. P., Apaza, R., Barmore, B., Battiste, V., Burian, B., Dao, Q., Feary, M., Go, S., Goodrich, K. H., Homola, J., et al., (2018). Urban air mobility airspace integration concepts and considerations. *Aviation Technology, Integration, and Operations Conference*.
- Thorbeck, J. (2012). TU Berlin DOC Method as Proposed in Lecture Notes: Flugzeugentwurf. *Technical University of Berlin: Berlin, Germany*.
- Tian, X., Geng, Y., Zhong, S., Wilson, J., Gao, C., Chen, W., ... & Hao, H. (2018). A bibliometric analysis on trends and characters of carbon emissions from transport sector. *Transportation Research Part D: Transport and Environment*, 59, 1-10.
- Time. (2021). The Best Inventions of 2021. Online: <https://time.com/collection/best-inventions-2021/6115299/xwing-automated-flight-technology/>
- Tomaszewska, E. J., & Florea, A. (2018). Urban smart mobility in the scientific literature— bibliometric analysis. *Engineering Management in Production and Services*, 10(2), 41-56.
- Transport Up. (2021, 11 Apr.). Orca Aerospace is Developing an eVTOL Air Ambulance for the Netherlands. <https://transportup.com/headlines-breaking-news/vehicles-manufactures/orca-aerospace-is-developing-an-evtol-air-ambulance-for-the-netherlands/>.
- Tuchen, S. Multimodal Transportation Operational Scenario and Conceptual Data Model For Integration With Uam. *Integrated Communications Navigation and Surveillance Conference (ICNS), Herndon, VA, USA, 2020, pp. 2C1-1-2C1-15, doi: 10.1109/ICNS50378.2020.9223002*.
- Tuchen, S. Role of Aviation in Seamless End-to-End Mobility. *IEEE/AIAA 37th Digital Avionics Systems Conference (DASC), London, UK, 2018, pp. 1-8, doi: 10.1109/DASC.2018.8569516*.
- Turk, T., & Trkman, P. (2012). Bass model estimates for broadband diffusion in European countries. *Technological Forecasting and Social Change*, 79(1), 85-96.
- UAM Geomatics (2021a). Urban Air Mobility | Economics and Global Markets - Forecasts for 84 Metropolitan Areas: 2021-2045.



- Venkatesh, N., Payan, A. P., Justin, C. Y., Kee, E., & Mavris, D. (2020). Optimal Siting of Sub-Urban Air Mobility (sUAM) Ground Architectures using Network Flow Formulation. In *AIAA AVIATION 2020 FORUM* (p. 2921).
- Wang, S., Zhan, X. Zhai, Y., Chi, C., and Liu, X. Ensuring High Navigation Integrity for Urban Air Mobility Using Tightly Coupled GNSS/INS System. *Journal of Aeronautics, Astronautics and Aviation*, Vol. 52, No. 4, pp. 429 – 442 (2020) 429 DOI: 10.6125/JoAAA.202012\_52(4).07
- Wedel, M., & Kamakura, W. A. (2000). *Market segmentation: Conceptual and methodological foundations*. Springer Science & Business Media.
- Wei, L., Justin, C., Briceno, S., and Mavris, D. Door-to-Door Travel Time Comparative Assessment for Conventional Transportation Methods and Short Takeoff and Landing On Demand Mobility Concepts. *Aviation Technology, Integration, and Operations Conference*. June 25-29, 2018, Atlanta, Georgia. <https://doi.org/10.2514/6.2018-3055>
- West, J. and Sherry, L. (2020). Agent-Based Simulation of Metropolitan Area Evacuation by Unmanned Air Mobility. *Integrated Communications Navigation and Surveillance Conference (ICNS)*, Herndon, VA, USA, 2020, pp. 6B1-1-6B1-6, doi: 10.1109/ICNS50378.2020.9222890.
- Windle, S. (2019). *ProcurementIQ Procurement Report: 21118343 Unmanned Aerial Vehicles*. IBIS World.
- WINGX (2022a). *WINGX Business Aviation Bulletin and Dashboard*. Retrieved May 30, 2022, from <https://wingx-advance.com/>.
- WINGX (2022b, May 5). *April closes with another double-digit growth in bizjet activity*. <https://wingx-advance.com/april-closes-with-another-double-digit-growth-in-bizjet-activity/>.
- Withrow-Maser, S., Malpica, C., Nagami, K. Multirotor Configuration Trades Informed by Handling Qualities for Urban Air Mobility Application. Vertical Flight Society's 76th Annual Forum & Technology Display, Virginia Beach, Virginia, USA, Oct. 6-8, 2020.
- World Bank. (2009). *Air Freight: A Market Study with Implications for Landlocked Countries*. Online: <https://www.worldbank.org/en/topic/transport/publication/air-freight-study>
- Xwing. (2021). Tetron & Xwing Partner to Accelerate Autonomous Flights. Online: <https://futureflight.aero/news-article/2021-10-12/tetron-teams-xwing-bring-autonomous-flight-capability-its-aircraft>
- Yang, X., Deng, L., and Wei, P. Multi-Agent Autonomous Operations in Urban Air Mobility with Communication Constraints. *AIAA Scitech Forum*. 6-10 January 2020, Orlando, FL. <https://doi.org/10.2514/6.2020-1839>
- Yankelovich, D., & Meer, D. (2006). Rediscovering market segmentation. *Harvard Business Review*, 84(2), 122.
- Yedavalli, P. and Mooberry, J. (2019). An Assessment of Public Perception of Urban Air Mobility (UAM). Online: <https://www.airbusutm.com/uam-resources-community-perception>

- Yeyati, E. and Filippini, F. (2021). Social and economic impact of COVID-19. Brookings Institution. Online: <https://www.brookings.edu/wp-content/uploads/2021/06/Social-and-economic-impact-COVID.pdf>
- Young, L. (2020). Accessibility Design and Operational Considerations in the Development of Urban Aerial Mobility Vehicles and Networks. *NASA Ames Research Center*.
- Zapico, J. M., Crossley, W. A., & Sun, D. (2021). Assessing potential urban air mobility traffic density in a metropolitan area like Chicago. West Lafayette : Purdue University.
- Zart, N. (2019). Airbus Reveals UTM Blueprint and UAM Perceptions.
- Zhu, J., & Liu, W. (2020). A tale of two databases: The use of Web of Science and Scopus in academic papers. *Scientometrics*, 1-15.
- Zupic, I., & Čater, T. (2015). Bibliometric methods in management and organization. *Organizational Research Methods*, 18(3), 429-472.

## 2.5 Appendix A: UAM Passenger Market Supplemental Resources

### 2.5.1 Direct and Indirect Operational Cost Parameters and Assumptions

Goyal et al. (2021) conducted a comprehensive cost analysis on the direct and indirect operating costs that original equipment manufacturers need to consider when entering the AAM passenger market. Table 2.23, Table 2.24, and Table 2.25, contain the assumptions that Goyal et al. (2021) used for their analysis.

Table 2.23. Operational Parameters (Goyal et al., 2021).

Element	Details / Parameter Assumptions	Min Assumption	Max Assumption
Number of Aircraft Seats (passenger seats = aircraft seats – 1)	Assumption: operation requires pilot	1	5
Load Factor %	# of seats occupied by a revenue passenger divided by total # of available seats	50%	80%
Utilization (annual # of flight hours)	Assumption: 2+ seat aircraft	1000	2000
Utilization (annual # of flight hours)	Assumption: 2-seat aircraft	500	1600
Max Reserve (min)	Flight time for the time outside of the mission time at specified altitude	20	30
Dead-end Trips %	Ratio of non-revenue trips and total trips	25%	50%
Detour Factor %	Lateral track inefficiencies equal to the ratio of actual flight distance divided by great circle distance between 2 vertiports	5%	15%
Cruise Altitude (ft)	For UAM vehicles	500	5000
Embarkation time (mins)	Time spent during the process of loading UAM vehicle with passengers and preparing them for takeoff	3	5
Disembarkation time (mins)	Time required for passengers to disembark the UAM vehicle after the flight	2	3
Battery Depth of Discharge %	Degree to which a battery was discharged in relation to its total capacity	50%	80%

Table 2.24. Cost Components for AAM Passenger Market OEMs (Goyal et al. (2021)).

Element	Details / Parameter Assumptions	Min Assumption	Max Assumption
Capital and Insurance Cost	Vehicle flight (hours)	12k	15k
	Depreciation Rate (%)	5%	10%
	Finance Rate (%)	5%	10%
Energy and Battery Cost	Battery Specific Energy (Wh/kg)	300	400
	Battery Capacity Specific Cost (\$/kWh)	200	250
	Energy Conversion Efficiency (%)	90%	98%
Crew Cost	Pilot Salary per year (US \$)	50k	90k
	Ground Crew Salary per year (US \$)	20k	30k
Infrastructure Cost	Cost of one super charger (US \$)	200k	300k
	Cost of one regular charger (US \$)	10k	20k
Maintenance Cost	Mechanic Wrap Rate (\$/hr.)	\$60	\$100
	Maintenance man-hours per flight hour	25%	1

Table 2.25. Market Development Scenario Comparisons (Goyal et al. (2021)).

Elements	Assumption
Reduction in Li-ion battery costs annually until 2025 (USD)	\$10/kWh reduction
High Network Efficiency - Utilization (supercharging abilities assumed)	~4 hours/day to ~7 hours/day
High Network Efficiency - Load Factor (%)	~65% to ~80%
High Network Efficiency – Dead End Trips (%)	~37.5% to ~20%
Increased penetration rates for the public's willingness to adopt Autonomous Vehicles from 2025 to 2035 (%)	0.5% to 10%
Calculated increase in telecommuting annually (%)	~10% annual

### ***2.5.2 UAM Passenger Demand Validation – Cumulative Demand by Location***

Table 2.26 shows cumulative demand for uncrewed passenger flights from 2020 through 2045 within each selected US domestic market. For example, in New York City, it is estimated that more than 140 million uncrewed passenger flights will occur from the present day through 2045. Fine-tuning the demand projections from UAM Geomatics (2021), the research team developed interim estimates of demand from the present day through 2045, as shown in Table 2.27 and

Table 2.28. These estimates served as guideposts for the ASSURE A36 project team’s market penetration analysis, which used a bass diffusion modeling framework.<sup>11</sup>

Table 2.26. Estimated City Demand by Phase (UAM Geomatics, 2021).

City	City Demand by Phase (Cumulative Demand)				
	2020-2024	2025-2029	2030-2034	2035-2039	2040-2045
Los Angeles	267,720	3,250,000	10,690,000	28,970,000	59,560,000
New York	658,850	2,860,000	27,110,000	73,150,000	145,990,000
Dallas-Fort Worth-Arlington	352,560	3,610,000	12,460,000	35,960,000	77,120,000
Houston	131,170	1,780,000	5,460,000	14,330,000	29,380,000
Philadelphia	87,190	994,450	3,120,000	8,810,000	19,090,000
Chicago	267,870	3,620,000	11,530,000	30,120,000	59,850,000
Washington, DC	242,860	3,180,000	10,950,000	28,370,000	54,650,000
Detroit	63,220	914,100	2,570,000	6,670,000	14,330,000
Atlanta	107,020	1,730,000	5,290,000	12,880,000	24,680,000
Boston	82,690	1,190,000	3,120,000	8,160,000	18,800,000
Miami	74,490	1,150,000	3,420,000	8,550,000	16,920,000
New Orleans	40,110	290,250	1,040,000	3,500,000	8,490,000
Denver	110,510	1,620,000	4,850,000	12,390,000	24,980,000
Baltimore	62,670	1,000,000	2,960,000	7,280,000	14,470,000
Phoenix	95,720	1,280,000	3,880,000	10,260,000	21,480,000
Orlando	72,940	1,060,000	3,090,000	7,960,000	16,560,000
Hampton	34,990	158,130	783,730	3,110,000	7,980,000
Tampa	31,560	442,310	1,290,000	3,370,000	7,080,000
Columbus	62,800	472,670	1,790,000	5,790,000	13,290,000
Salt Lake City	28,370	426,700	1,260,000	3,180,000	6,440,000
Cincinnati	55,010	449,500	1,580,000	5,050,000	11,780,000
Seattle	133,570	1,730,000	5,860,000	15,350,000	29,930,000
Cleveland	55,230	583,410	1,860,000	5,440,000	11,980,000
Minneapolis-St. Paul	141,970	1,360,000	4,580,000	13,570,000	30,580,000
Portland	27,910	416,680	1,280,000	3,220,000	6,340,000
San Francisco	138,470	2,320,000	7,760,000	18,290,000	32,550,000
Akron	21,200	85,120	561,050	2,540,000	6,900,000
San Diego	50,770	672,440	2,130,000	5,610,000	11,400,000
Charlotte	50,770	672,440	2,130,000	5,610,000	11,400,000
Las Vegas	60,470	994,380	2,960,000	7,210,000	13,960,000
Dayton	22,270	95,180	467,550	1,970,000	5,320,000
Toledo	72,940	1,060,000	3,090,000	7,960,000	16,560,000
Reno	16,740	218,220	672,900	1,800,000	3,720,000
Raleigh-Durham-Chapel Hill	44,690	348,520	1,370,000	4,290,000	9,580,000
Syracuse	12,540	51,590	245,700	1,090,000	3,010,000
Wichita	10,720	47,080	209,660	865,850	2,330,000
Nashville	22,490	310,370	946,270	2,470,000	5,050,000
San Jose	35,030	508,590	1,790,000	4,420,000	8,060,000
Cumulative Demand	3,848,100	42,952,130	156,156,860	419,565,850	861,590,000

<sup>11</sup> UAM Geomatics (2021) demand estimates are for 38 U.S. cities, whereas the A36 market penetration analysis analyzed 30 viable MSAs coming online from 2024-2045. MSAs were determined from a site suitability analysis.



Table 2.27. AAM Passenger Mobility Flight Demand Over Time by Major and Midsize US Market.

MSA	Suitability Score	2024	2025	2026	2027	2028	2029	2030	2031	2032	2033	2034	2035
New York-Newark-Jersey City, NY-NJ-PA	74.13	70,510	191,080	397,260	749,820	1,350,000	1,590,000	1,660,000	1,840,000	3,070,000	3,400,000	3,790,000	4,240,000
Los Angeles-Long Beach-Anaheim, CA	66.23	28,650	77,650	161,430	304,960	549,670	675,380	697,960	757,720	1,190,000	1,310,000	1,470,000	1,640,000
Orlando-Kissimmee-Sanford, FL	33.92	7,970	21,610	44,920	84,780	152,950	260,980	283,400	294,320	384,600	413,190	446,220	486,010
Miami-Fort Lauderdale-Pompano Beach, FL	32.67	7,810	21,160	43,980	83,010	149,760	246,610	249,840	259,150	340,830	366,030	398,000	437,420
Dallas-Fort Worth-Arlington, TX	39.27					662,120	686,160	715,580	792,650	1,370,000	1,530,000	1,730,000	1,960,000
Boston-Cambridge-Newton, MA-NH	36.00					169,780	279,980	281,150	284,790	332,260	351,200	376,430	409,850
Columbus, OH	31.73					76,950	80,410	84,690	96,360	192,080	219,780	255,290	298,360
Minneapolis-St. Paul-Bloomington, MN-WI	31.15					248,140	255,290	264,180	288,560	491,800	551,230	627,680	720,720
San Jose-Sunnyvale-Santa Clara, CA	34.22							117,660	132,310	213,570	232,980	253,580	277,990
Detroit-Warren-Dearborn, MI	32.73							215,090	221,010	279,400	299,310	324,350	355,990
San Francisco-Oakland-Berkeley, CA	31.81							602,320	651,530	933,610	1,100,000	1,080,000	1,160,000
Chicago-Naperville-Elgin, IL-IN-WI	30.73							820,590	877,470	1,290,000	1,420,000	1,560,000	1,720,000
Bridgeport-Stamford-Norwalk, CT	28.41												
Washington-Arlington-Alexandria, DC-VA-MD-WV	28.29												
Houston-The Woodlands-Sugar Land, TX	27.83												
Riverside-San Bernardino-Ontario, CA	26.82												
Philadelphia-Camden-Wilmington, PA-NJ-DE-MD	25.16												
Indianapolis-Carmel-Anderson, IN	24.96												
Seattle-Tacoma-Bellevue, WA	24.82												
Allentown-Bethlehem-Easton, PA-NJ	24.45												
Atlanta-Sandy Springs-Alpharetta, GA	24.06												
Madison, WI	23.73												
Providence-Warwick, RI-MA	23.64												
Poughkeepsie-Newburgh-Middletown, NY	23.57												
Hartford-East Hartford-Middletown, CT	23.10												
Pittsburgh, PA	23.05												
Wichita, KS	22.81												
Portland-Vancouver-Hillsboro, OR-WA	22.73												
Cleveland-Elyria, OH	22.72												
Milwaukee-Waukesha, WI	22.43												
<b>Totals</b>		114,940	311,500	647,590	1,222,570	3,359,370	4,074,810	5,992,460	6,495,870	10,088,150	11,193,720	12,311,550	13,706,340

Table 2.28. AAM Passenger Mobility Flight Demand Over Time by Major and Midsize US Market (continued).

MSA	Suitability Score	2036	2037	2038	2039	2040	2041	2042	2043	2044	2045	Totals
New York-Newark-Jersey City, NY-NJ-PA	74.13	4,760,000	5,360,000	6,110,000	6,970,000	7,940,000	9,150,000	10,520,000	11,870,000	13,220,000	14,570,000	112,818,670
Los Angeles-Long Beach-Anaheim, CA	66.23	1,830,000	2,080,000	2,380,000	2,750,000	3,150,000	3,640,000	4,270,000	4,890,000	5,500,000	6,120,000	45,473,420
Orlando-Kissimmee-Sanford, FL	33.92	537,210	599,290	673,920	770,530	877,010	1,030,000	1,190,000	1,350,000	1,510,000	1,670,000	13,088,910
Miami-Fort Lauderdale-Pompano Beach, FL	32.67	487,600	549,550	625,520	717,900	838,840	973,620	1,160,000	1,350,000	1,530,000	1,720,000	12,556,630
Dallas-Fort Worth-Arlington, TX	39.27	2,260,000	2,580,000	2,990,000	3,480,000	4,090,000	4,730,000	5,630,000	6,500,000	7,360,000	8,230,000	57,296,510
Boston-Cambridge-Newton, MA-NH	36.00	457,280	515,830	598,070	705,810	858,750	1,040,000	1,320,000	1,590,000	1,860,000	2,130,000	13,561,180
Columbus, OH	31.73	350,270	412,320	485,720	579,600	690,690	833,590	1,000,000	1,170,000	1,330,000	1,500,000	9,656,110
Minneapolis-St. Paul-Bloomington, MN-WI	31.15	833,230	968,160	1,130,000	1,330,000	1,580,000	1,890,000	2,270,000	2,630,000	3,000,000	3,370,000	22,448,990
San Jose-Sunnyvale-Santa Clara, CA	34.22	305,320	335,750	369,370	409,300	453,000	501,740	559,110	615,100	671,930	728,350	6,177,060
Detroit-Warren-Dearborn, MI	32.73	398,330	447,850	513,760	595,540	705,360	828,970	1,010,000	1,180,000	1,360,000	1,530,000	10,264,960
San Francisco-Oakland-Berkeley, CA	31.81	1,260,000	1,370,000	1,500,000	1,650,000	1,810,000	1,990,000	2,210,000	2,420,000	2,640,000	2,850,000	25,227,460
Chicago-Naperville-Elgin, IL-IN-WI	30.73	1,920,000	2,160,000	2,450,000	2,800,000	3,190,000	3,710,000	4,280,000	4,830,000	5,390,000	5,950,000	44,368,060
Bridgeport-Stamford-Norwalk, CT	28.41			91,060	113,610	146,730	184,740	235,850	285,570	335,300	385,040	1,777,900
Washington-Arlington-Alexandria, DC-VA-MD-WV	28.29			2,450,000	2,800,000	3,190,000	3,710,000	4,280,000	4,830,000	5,390,000	5,950,000	32,600,000
Houston-The Woodlands-Sugar Land, TX	27.83			1,150,000	1,320,000	1,520,000	1,780,000	2,090,000	2,400,000	2,710,000	3,010,000	15,980,000
Riverside-San Bernardino-Ontario, CA	26.82			127,210	160,100	196,540	248,850	312,790	375,400	438,020	500,650	2,359,560
Philadelphia-Camden-Wilmington, PA-NJ-DE-MD	25.16			709,120	831,350	977,190	1,170,000	1,390,000	1,610,000	1,830,000	2,060,000	10,577,660
Indianapolis-Carmel-Anderson, IN	24.96			485,720	579,600	690,690	833,590	1,000,000	1,170,000	1,330,000	1,500,000	7,589,600
Seattle-Tacoma-Bellevue, WA	24.82			1,280,000	1,440,000	1,630,000	1,870,000	2,130,000	2,390,000	2,650,000	2,920,000	16,310,000
Allentown-Bethlehem-Easton, PA-NJ	24.45			219,380	272,430	342,590	427,800	541,020	651,210	761,460	871,710	4,087,600
Atlanta-Sandy Springs-Alpharetta, GA	24.06			1,020,000	1,150,000	1,300,000	1,490,000	1,710,000	1,930,000	2,140,000	2,360,000	13,100,000
Madison, WI	23.73			127,210	160,100	196,540	248,850	312,790	375,400	438,020	500,650	2,359,560
Providence-Warwick, RI-MA	23.64			219,380	272,430	342,590	427,800	541,020	651,210	761,460	871,710	4,087,600
Poughkeepsie-Newburgh-Middletown, NY	23.57			166,340	206,510	260,030	325,540	413,260	498,590	583,960	669,340	3,123,570
Hartford-East Hartford-Middletown, CT	23.10			166,340	206,510	260,030	325,540	413,260	498,590	583,960	669,340	3,123,570
Pittsburgh, PA	23.05							180,250	217,550	254,880	292,210	944,890
Wichita, KS	22.81							180,250	217,550	254,880	292,210	944,890
Portland-Vancouver-Hillsboro, OR-WA	22.73							445,490	504,980	564,490	623,990	2,138,950
Cleveland-Elyria, OH	22.72							881,580	1,020,000	1,170,000	1,310,000	4,381,580
Milwaukee-Waukesha, WI	22.43							713,430	827,770	942,170	1,060,000	3,543,370
<b>Totals</b>		15,399,240	17,378,750	28,038,120	32,271,320	37,236,580	43,360,630	53,190,100	60,848,920	68,510,530	76,215,200	501,968,260

As a validation exercise for the project team’s diffusion modeling efforts, market projections from the present through 2045 were estimated using guideposts from the literature. The research team aligned market projections from existing research to the MSAs identified in the site suitability analysis. After an extensive review of AAM passenger mobility market research, it was found that market projections from UAM Geomatics (2021) could be reworked and assigned to MSAs to make the site suitability analysis and bass diffusion demand estimation spatially compatible. Additionally, the timing for market transitions, when new markets came online, were estimated using the AAM market development progression framework and milestones developed by Hussain and Silver (2021) and shown in Figure 2.1.

The UAM Geomatics online dashboard provides estimates of AAM passenger mobility demand for 38 US cities from 2022 through 2045. Though the estimates are generally more optimistic than what is observed in the literature, as shown in Figure 2.26, their market forecasts offer a useful benchmark for demand estimation.

City estimates were fitted to the metropolitan statistical areas that were identified in the site suitability analysis. In most instances, the MSAs that contained UAM Geomatics market forecast cities were used. This was the case for 20 of the 30 MSAs. In some instances, UAM Geomatics did not have market projections for cities that were geographically associated with an MSA identified from the site suitability analysis. In those instances, cities with similar populations to the primary urban center of the MSA were used.<sup>12</sup>

After conducting the interim demand meta-analysis, the team estimated 76.2 million AAM passenger mobility flights in the US in the year 2045. This equates to a cumulative flight total of approximately 502 million flights from 2024 through 2045. The growth trajectory of AAM passenger mobility can be seen in Table 2.29 and Figure 2.26. It is anticipated that each flight carries an average of 1.49 passengers (derived from Goyal et al., 2021).

Table 2.29. Domestic AAM Passenger Mobility Demand: Number of Flights.

Study	2022	2025	2030	2035	2040	2045
UAM Geomatics (2019)	3,751,150	4,741,210	19,314,830	28,840,730	59,540,300	123,122,360
UAM Geomatics (2020)	1,493,330	4,500,010	16,856,840	30,589,520	63,186,110	119,663,920
UAM Geomatics (2021)	411,980	4,278,290	17,341,850	29,864,320	61,457,850	105,497,210
KPMG (2019)	--	--	2,500,000	--	22,600,000	--
Booz Allen Hamilton (2018)	--	--	20,075,000	--	--	--
<b>ASSURE (2022)</b>	--	<b>311,500</b>	<b>5,992,460</b>	<b>13,706,340</b>	<b>37,236,580</b>	<b>76,215,200</b>

Based on AAM market milestones and development criteria established by Hussain and Silver (2021) and the ASSURE A36 site suitability analysis results, it was assumed that 30 MSAs would launch AAM passenger mobility services from 2024 through 2045.

<sup>12</sup> Syracuse was used as a proxy for Bridgeport-Stamford-Norwalk, CT; Toledo as a proxy for Riverside-San Bernardino-Ontario, CA and Madison, WI; Columbus as a proxy for Indianapolis-Carmel-Anderson, IN; Akron as a proxy for Allentown-Bethlehem-Easton, PA-NJ and Providence-Warwick, RI-MA; Dayton as a proxy for Poughkeepsie-Newburgh-Middletown, NY and Hartford-East Hartford-Middletown, CT; Wichita as a proxy for Pittsburgh, PA; and Raleigh-Durham-Chapel Hill as a proxy for Milwaukee-Waukesha, WI.

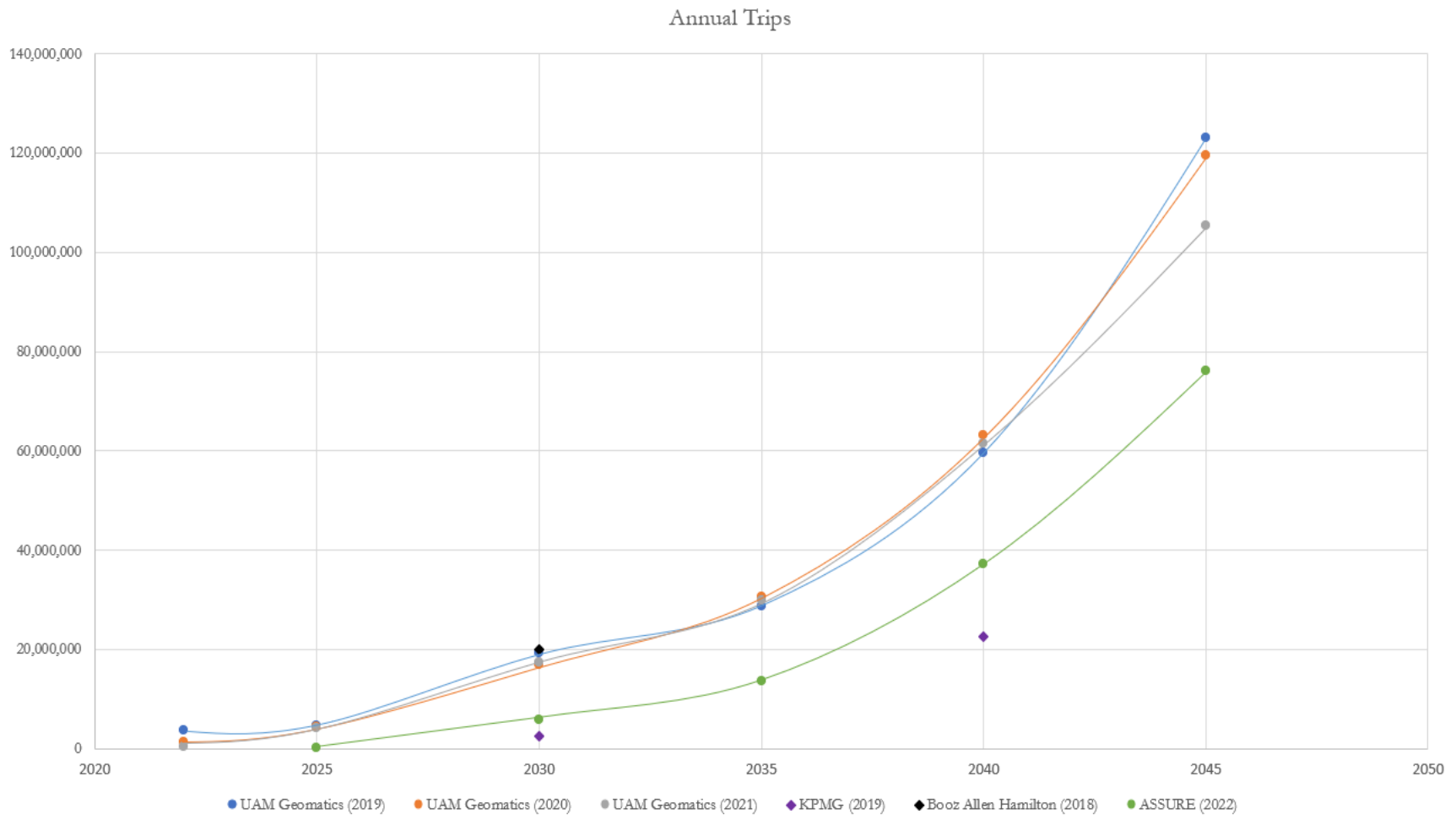

Figure 2.26. US AAM Passenger Flight Projections Over Time.

### 2.5.3 Other Guideposts Identified for Demand Validation

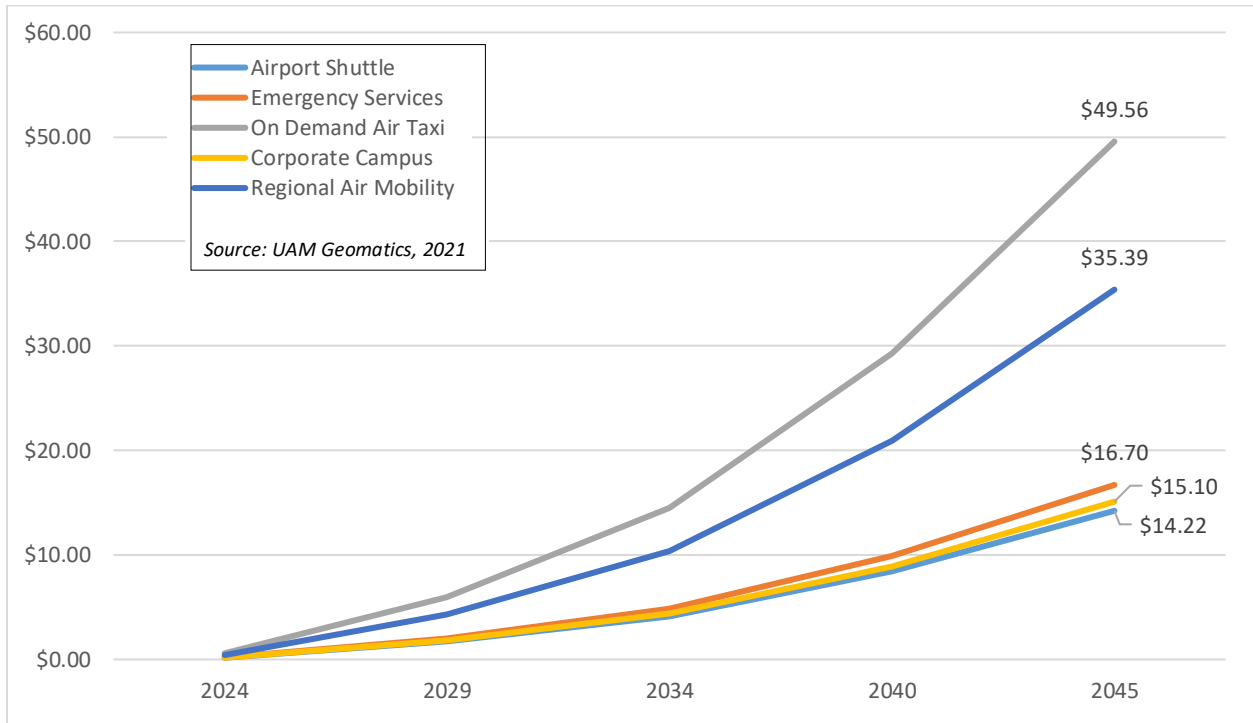

Figure 2.27. Cumulative Revenue by Use Case in US \$Billions (UAM Geomatics, 2021).

Table 2.30. US Market Share and Revenue by Use Case | UAM Geomatics, 2021.

Use Case	Share	2024	2029	2034	2040	2045
Airport Shuttle	10.9%	\$0.17	\$1.72	\$4.15	\$8.41	\$14.22
Emergency Services	12.8%	\$0.20	\$2.02	\$4.88	\$9.88	\$16.70
On Demand Air Taxi	37.8%	\$0.59	\$5.99	\$14.47	\$29.31	\$49.56
Corporate Campus	11.5%	\$0.18	\$1.83	\$4.41	\$8.93	\$15.10
Regional Air Mobility	27.0%	\$0.42	\$4.28	\$10.34	\$20.93	\$35.39
<b>Total</b>	<b>100.0%</b>	<b>\$1.57</b>	<b>\$15.84</b>	<b>\$38.25</b>	<b>\$77.47</b>	<b>\$130.98</b>

Source: UAM Geomatics, 2021

## 2.6 Appendix B: Site Suitability Analysis: Psychometric Validation and Site Segmentation

The SSA gathered a wide range of data on the different potential markets for AAM. The primary focus of this analysis was to rank metro areas for suitability for AAM development. However, the data generated for the SSA can also give more insight into the relative strengths and weaknesses of the different metros as markets for AAM and can be used to better understand the potential for different markets and the data can be used to help psychometrically validate the SSA index.

In this section, exploratory data analysis is used to examine the components of the SSA index and a principal components analysis is used to check the overall index agreement and relationships between the components and an overall “psychometric” index of market potential.

The components of the site suitability analysis are given in Table 2.31. The index is composed of constituent components in different sub-areas. These areas include urban structure, economic scale, congestion, readiness, and economic variables. These components are range-scaled between 0 and 1 and weighted in the overall index using the SMART method. The variable weights (adding up to 100) can be found in Table 5 in the site suitability analysis.

Table 2.31. Site Suitability Analysis Components.

Variable	Description
Urban Structure 1 (US1)	<i>Population Density</i> : Average population per square mile
Urban Structure 2 (US2)	<i>Polycentrism</i> : Number of employment subcenters
Economic Scale 1 (ES1)	<i>Fortune 1000 Presence</i> : Number of Fortune 1000 company headquarters
Economic Scale 2 (ES2)	<i>GDP per Capita</i> : Gross domestic product of MSA per capita
Congestion 1 (C1)	<i>Average Time to Work</i> : Average one-way commute time, minutes
Congestion 2 (C2)	<i>Travel Time Index</i> : Index of peak period to free-flow conditions
Congestion 3 (C3)	<i>Airport to CBD Drive Time</i> : Estimated driving time in free-flow conditions from commercial airports to central business district, weighted by number of commercial aircraft operations
Readiness 1 (R1)	<i>Heliports per Capita</i> : Number of heliports per capita
Readiness 2 (R2)	<i>Airports per Capita</i> : Number of airports per capita
Readiness 2 (R3)	<i>Class B Airspace</i> : Presence (or not) of Class B Airspace in MSA (0 present, 1 not present)
Readiness 3 (R4)	<i>Class G Airspace Congestion</i> : Average total hours per square mile in Class G airspace
Readiness 4 (R5)	<i>Public &amp; Private Investment</i> : UAM Launch City (1.0) or Headquarters City (0.5)
Economic Development (ED1)	<i>Airport Short-Haul OD &lt;150 Miles</i> : Count of flight origins and destinations within MSA for distances shorter than 150 miles

All variables are weighted positive in the SSA index, i.e., higher values of each variable are indicators of higher site suitability. However, this does not necessarily mean that all the indicators are strongly correlated with one another. For example, a large densely populated metro may have some advantages for UAM (e.g., high concentration of wealthy commuters, ground transportation congestion), but also have possible disadvantages (e.g., airspace congestion).

To examine the relationship between the variables and between the variables and the overall index, several analyses were carried out. First, inter-correlations were calculated between all of the variables in the SSA index, along with the overall population of each of the evaluated metro areas. The results are visualized in a correlation heatmap in Figure 2.28.

Here, positive correlations are shaded blue and negative correlations are shaded red. One can see that all the urban structure, economic scale, congestion, and economic development variables are strongly correlated with each other and with the overall metro population. This is due to the fact most of these variables are measures of economic power, which are quite strongly related to the size of the metro. For example, larger metro areas are likely to have more employment subcenters and thus higher polycentrism. They are also likely to have higher degrees of traffic congestion.

The only negatively correlated variables are the readiness variables, R1, R2, and R3. For R1 and R2 it may be that given a larger population, there is less population per heliport/airport, with smaller metros having a minimum number of low usage facilities, possibly subsidized by the Essential Air Service program (e.g., Grubestic & Wei, 2012; Hall et al., 2015). R3 is 1 if a metro does not have a Class B airspace (which will result in restrictions on UAM flights) and 0 if a metro does have a Class B airspace. As Class B airspaces tend to be found at airports in large metros, it is intuitive that smaller metros will on average have larger values of R3.

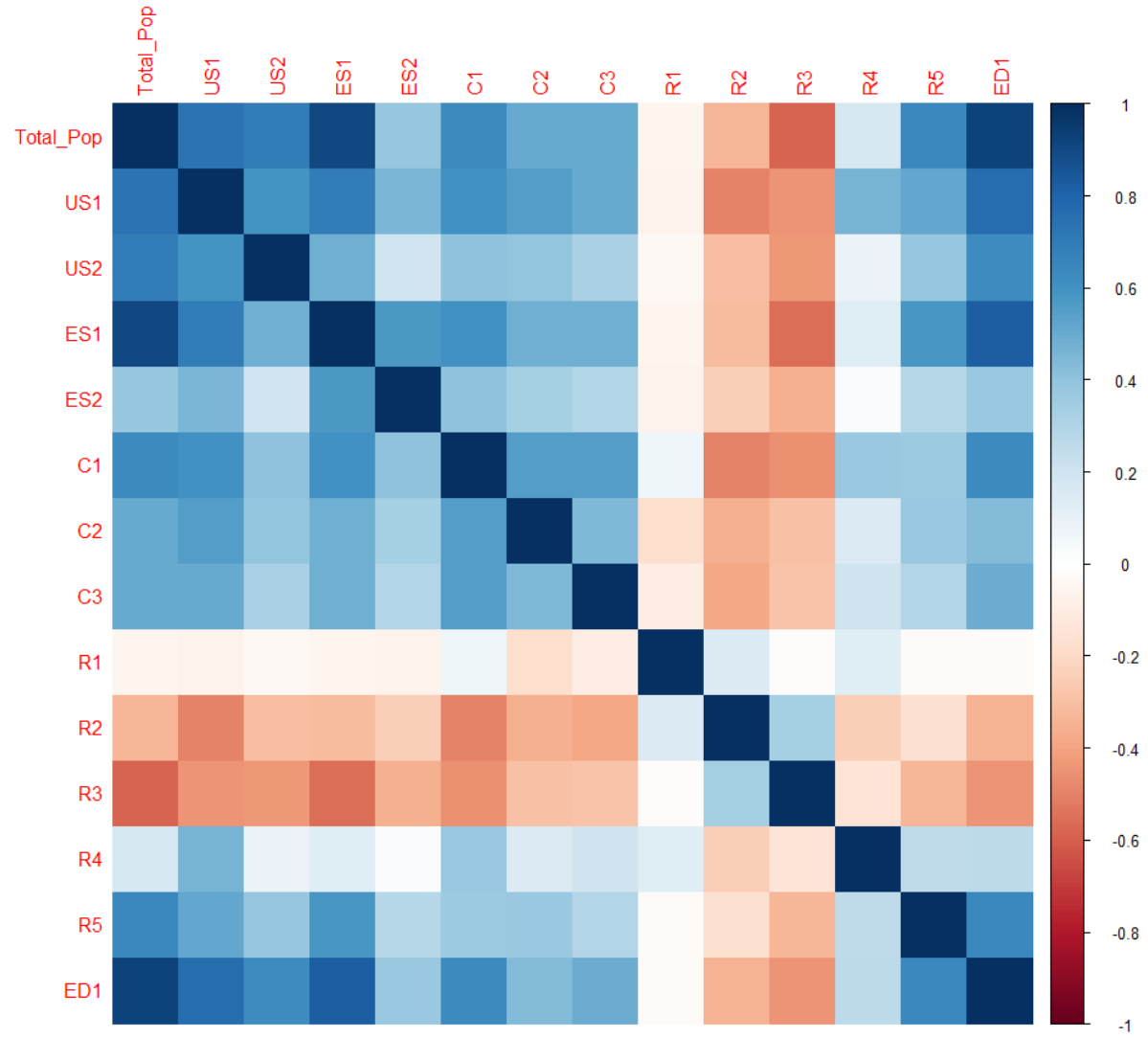

Figure 2.28. SSA Index Correlations.

To examine the patterns found in the correlation chart further, the values for each of the SSA index components were plotted using box plots for the metros that were selected as having the Top 10 values of the overall SSA index vs. the metros that had lower values of the SSA index. To give consistency between the variables, the variables were standardized by subtracting the mean and dividing by the standard deviation before plotting. The resulting comparisons, grouped by each

SSA index variable are given in Figure 2.29.<sup>13</sup> Similar results are achieved in the correlation analysis in that the total population and all SSA index constituent variables apart from R1, R2, and R3 have higher values for the Top 10 metros over the non-Top 10 metros. For R1 the Top 10 and non-Top 10 metro values have similar interquartile ranges, though there are several high outliers above 2 standard deviations for the non-Top 10 metros. As R3 is a binary variable, it is difficult to see a pattern, though it looks like apart from one outlier, all Top-10 values have the lowest value.

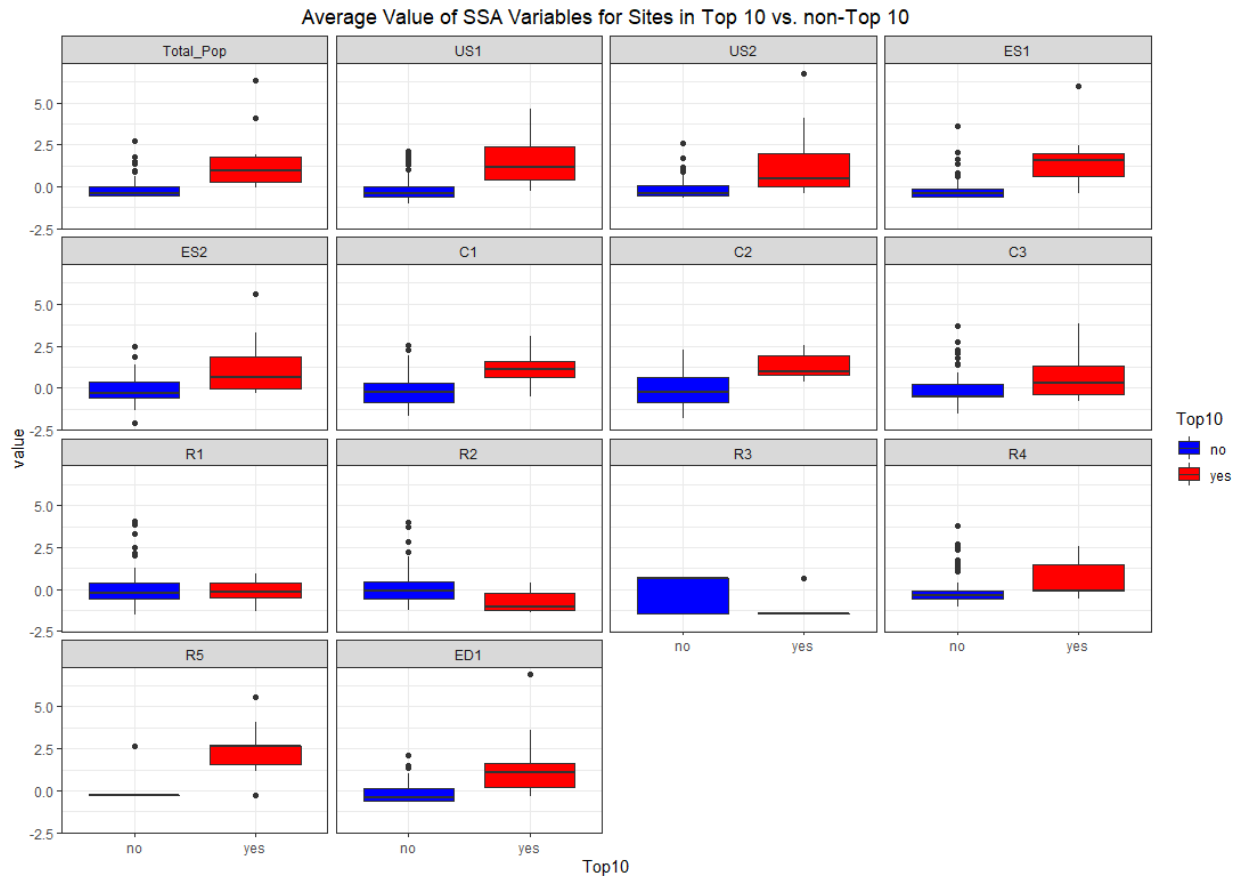

Figure 2.29. Average Value of SSA Variables for Sites in Top 10 vs. non-Top 10.

To further examine the properties of the SSA Index a Principal Components Analysis (PCA) was performed on the component constituents. PCA is a method commonly used for data reduction, de-noising data, and finding latent components in data (e.g., Dunteman, 1989; Shlens, 2014). In this analysis it is used for several purposes: i) To see if the site suitability variables load together into a single latent index, and ii) To see how the index components relate to the overall index. PCA works by extracting new mutually uncorrelated data variables from the original data, with each new data variable maximizing the amount of explained data variance.

A PCA was run for the site suitability data. The amount of variation included in each of the new dimensions is plotted in a “scree plot” in Figure 2.30. Scree plots can be used to choose the number of useful dimensions in the PCA solution (Jackson, 1993; Zhu & Ghodsi, 2006). One rule of

<sup>13</sup> The center of a box denotes the median, the bottom of the box the 25<sup>th</sup> percentile, the top of the box the 75<sup>th</sup> percentile, and the top/bottom lines the lowest/highest values excluding plotted outliers.



thumb is to select the number of dimensions before the “convex hull”, i.e., the elbow of the curve, where the angle of the graph changes from an obtuse to an acute angle. In the solution in Figure 2.30, the first dimension dominates all others with 44.0% of the data variance and is the only dimension before the elbow of the graph, which implies that a single dimension solution, in this case of market potential, may be appropriate.

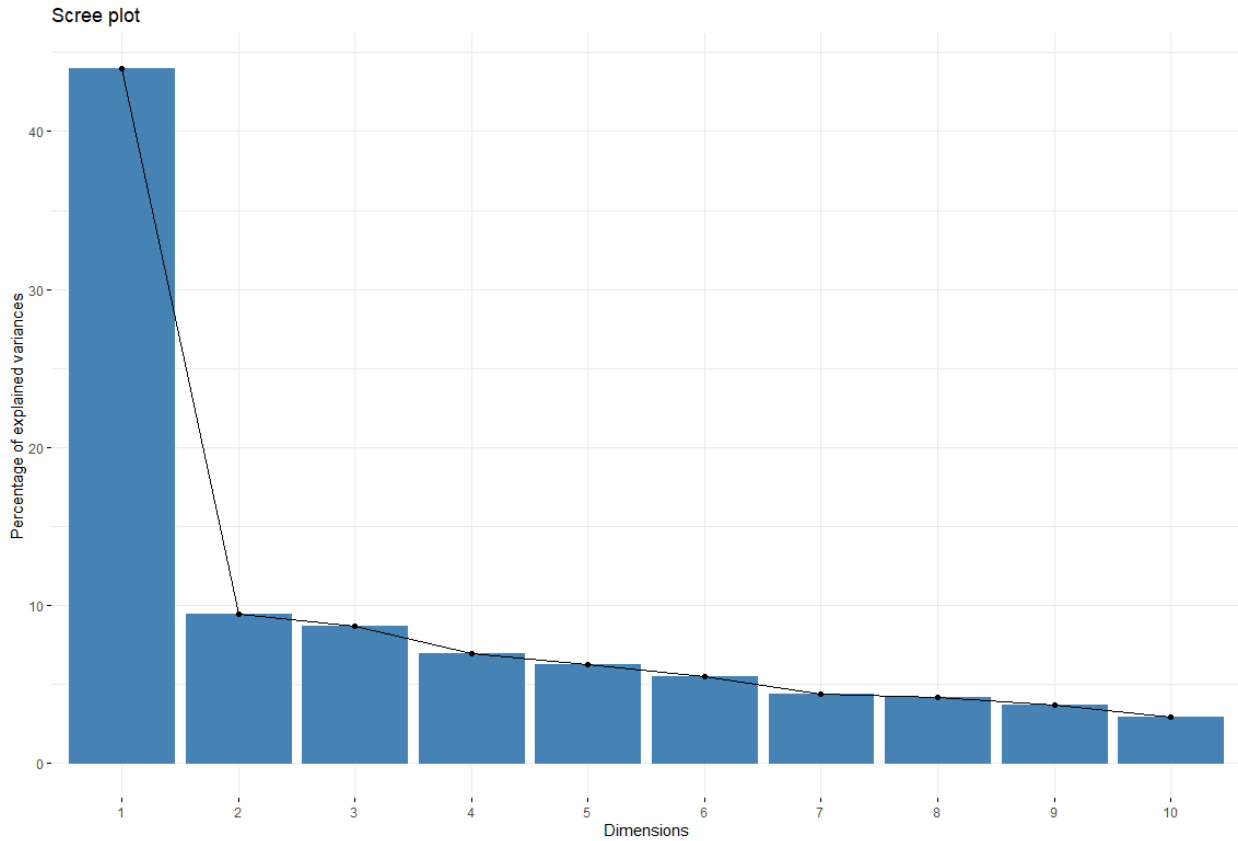

Figure 2.30. PCA Scree Plot.

In PCA, a biplot (Gabriel, 1971; Gower et al. 2011) can be used to show the relationship between the new dimensions of a derived solution and the original variables. To aid plotting, a second dimension was added, which accounted for an additional 9.5% of the data variance. The PCA biplot is given in Figure 2.31. Here, the numbered items, show the positions of the sites on the new dimensions and the blue arrow vectors show the relationships between the original variables and the new dimensions. The direction of a vector relates to how its variable contributes relatively to the new dimensions, and the length of the vector relates to the strength of this orientation. Here, both R1 and R4 show strong positive associations with the 2<sup>nd</sup> new dimension, and the remaining variables are mostly negatively associated with the 1<sup>st</sup> main dimension, with a few positively associated.

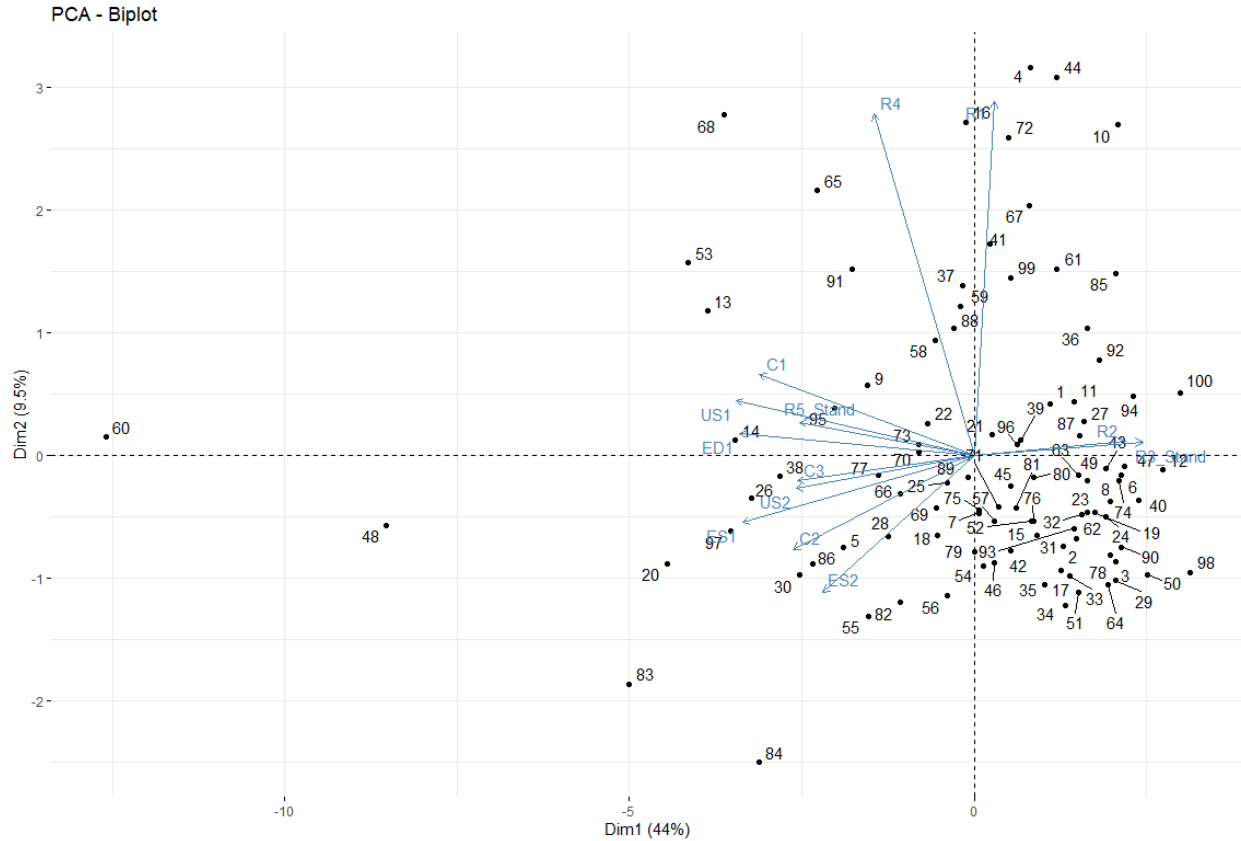

Figure 2.31. PCA Biplot.

In PCA, the signs of different dimensions are arbitrary and given that the 1<sup>st</sup> dimension is negatively related to most of the original variables, the sign of this dimension was swapped to make it a positive measure of market potential. In addition, in PCA, rotation of the solution is often performed to help simplify (i.e., make either close to 1 or 0) the correlations between the new variables and the original variables. The commonly used Varimax rotation (Kaiser, 1958), which preserves the orthogonality of the dimensions, was used to create the simplified structure. Varimax rotation is orthogonal (Jennrich, 1970), in that the resulting dimensions remain mutually uncorrelated. The final loadings (correlations between the dimensions and the original variables) for the first two new variables are given in Table 2.32. Loadings with an absolute value of greater than 0.5 are highlighted.

Table 2.32. Final PCA Loadings of Rotated Solution.

Variable	RPC1	RPC2
US1 - Population Density	<b>0.858</b>	0.207
US2 - Polycentrism	<b>0.659</b>	0.003
ES1 - Fortune 1000 Presence	<b>0.863</b>	-0.045
ES2 - GDP per Capita	<b>0.584</b>	-0.222
C1 - Average Time to Work	<b>0.768</b>	0.251
C2 - Travel Time Index	<b>0.683</b>	-0.122
C3 - Airport to CBD Drive Time	<b>0.652</b>	0.018
R1 - Heliports per Capita	-0.154	<b>0.720</b>
R2 - Airports per Capita	<b>-0.557</b>	-0.032
R3- Class B Airspace (0 present, 1 not present)	<b>-0.620</b>	-0.040
R4 - Class G Airspace Congestion	0.290	<b>0.742</b>
R5 - Public & Private Investment	<b>0.632</b>	0.138
ED1 - Airport Short-Haul OD <150 Miles	<b>0.853</b>	0.139

The first principal component is strongly positively loaded on all variables apart from R1-R4, in concordance with overall market size potential. However, R2 and R3 have negative loadings on this dimension. For R2, as previously noted in the correlation discussion, smaller metros may have more airports per capita than larger metros. For R3, class B airspace is more likely to be present in larger metros. Overall, the first dimension can be thought of as an aggregate measure of market potential based on market size. Thus, this dimension is named “Market Potential”. The second dimension (while less important in terms of variance explained) is positively loaded on R1 - heliports per capita and R4 - the level of class G airspace congestion. As class G airspace tends to be lower-level airspace, the overall dimension is named “Low Level Infrastructure Utilization”.

The sites from the site suitability analysis, plotted on the two new derived dimensions described above, are given in Figure 2.32 and with log-scaled dimensions in Figure 2.33.

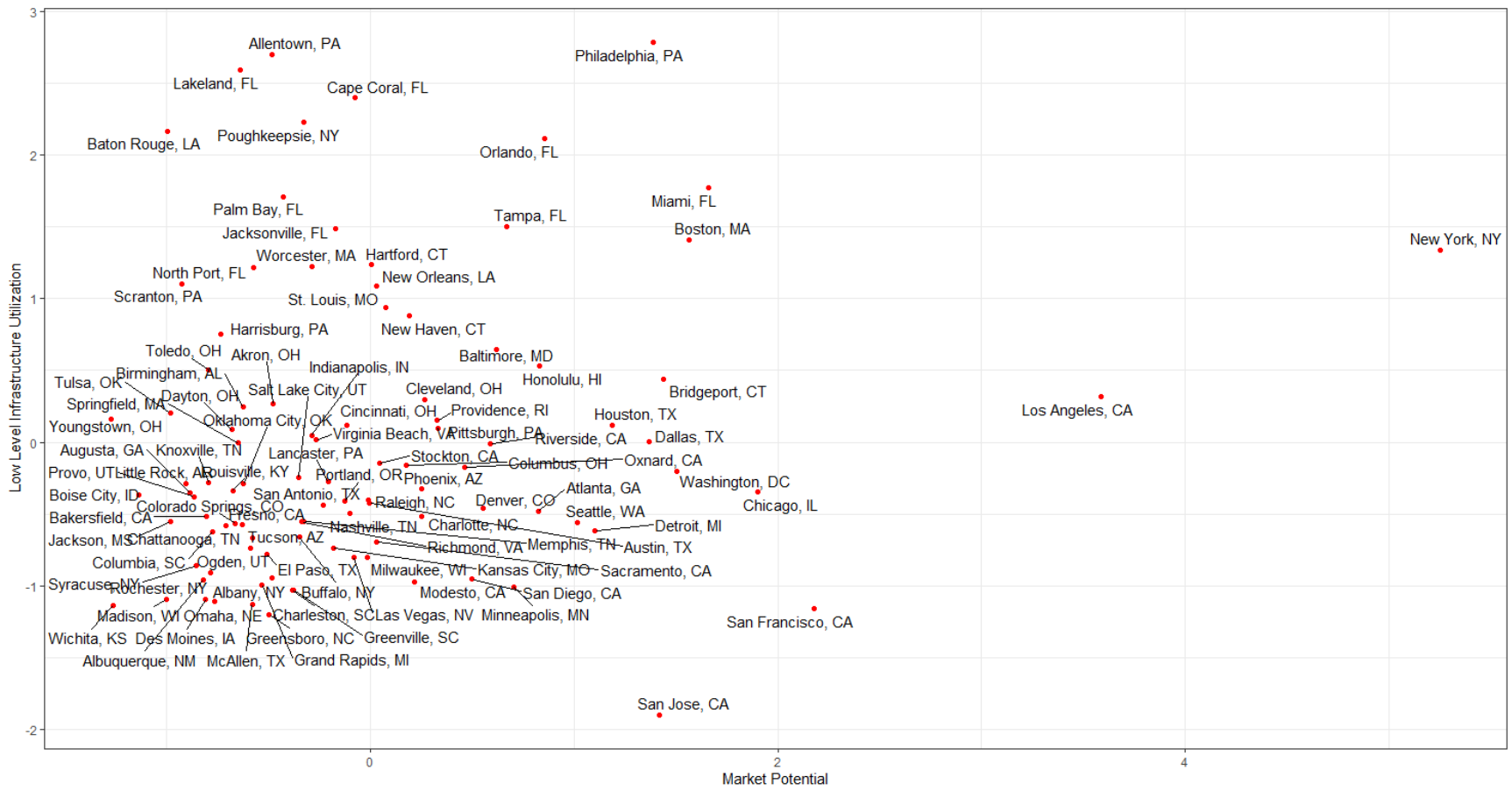

Figure 2.32. Site Suitability Analysis Derived Dimensions.

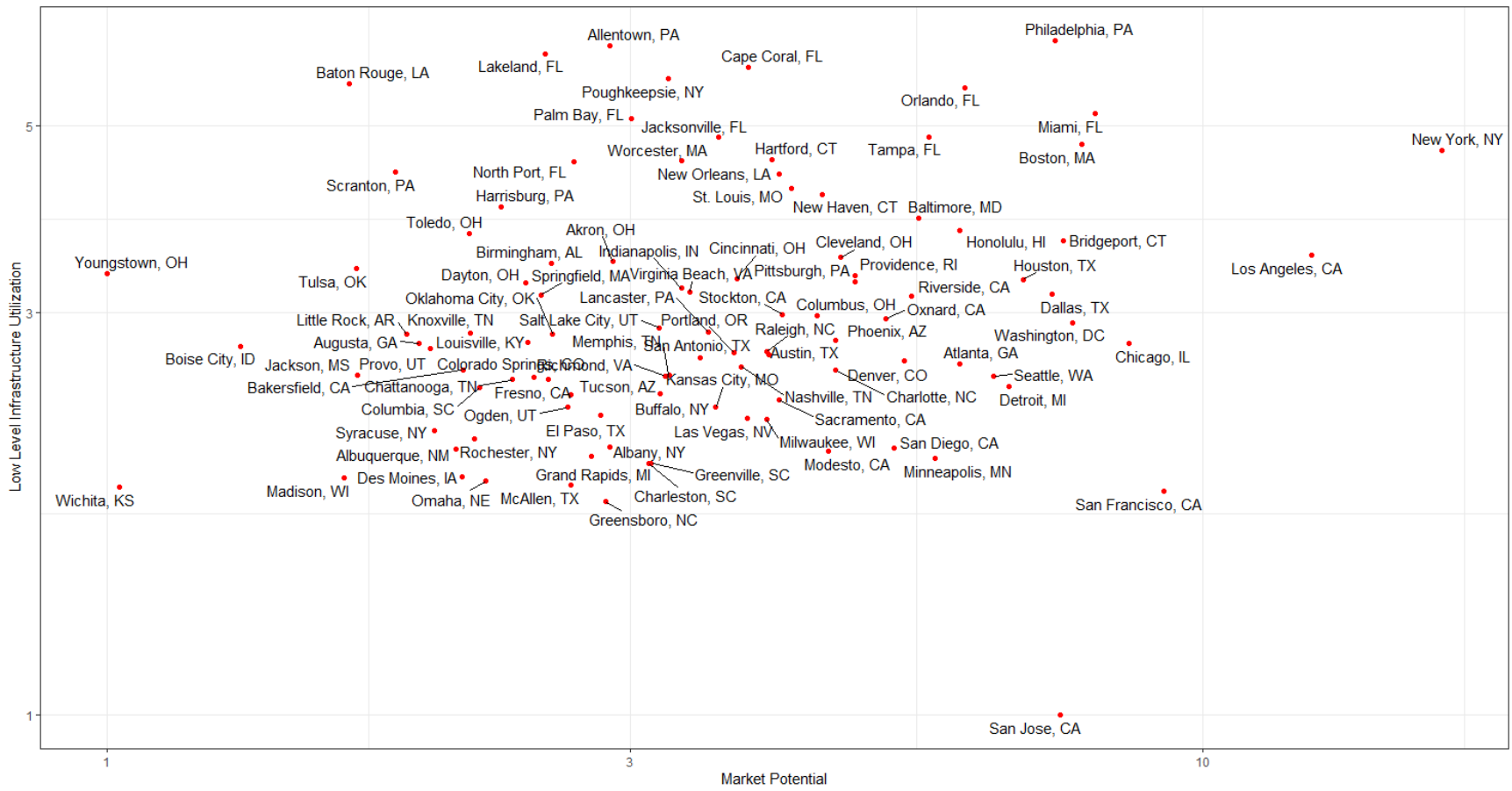

Figure 2.33. Site Suitability Analysis Derived Dimensions on Log Scale.

There are several uses for the scatterplots in Figure 2.32 and Figure 2.33. First, they can show the relative placement of the different markets, particularly on the market potential scale. For example, New York has by far the highest market potential on this scale. Second, in market segmentation applications, this sort of scatterplot visualization is used to identify similar markets to a current successful market for market entry (Kale & Sudharshan, 1987; Wind & Douglas, 1972). For example, in terms of characteristics, Huston, TX and Dallas, TX are similar, and less obviously from a geographical perspective, Boston, MA and Miami, FL are similar.

In fact, representations of “closeness” of metro areas can be calculated from the other data. To examine similarities between the Top 25 ranked metros for the site suitability analysis, the population value plus the values of the 13 SSA variables were standardized (subtracting mean and dividing by the standard deviation), and Euclidean distances were calculated on these data between each pair of cities. These distances were then clustered using agglomerative hierarchical clustering using Ward’s method (Murtagh & Legendre, 2014; Ward Jr, 1963), which mimizes the data variance within clusters. The resulting output, in the form of a dendrogram showing cluster structure, is plotted in Figure 2.34. Here, the similarity between markets can be expressed as how close the markets are on the tree and the depth of the tree at which they were joined. For example, the “first” join is between Washington, DC and Atlanta, GA. Both of these metro areas have similar population and congestion characteristics. The ‘second’ join is between Poughkeepsie, NY and Allentown, PA, both towns being midsized towns, just outside of the New York City metro areas and with similar characteristics. Interestingly New York, NY and Los Angeles, CA are joined together as the nearest metros to each other, but quite late in the process. This is probably because the two metros are not comparable to other metros in terms of sheer economic scale, but that there are still significant differences between the metros in terms of economic structure. To give discrete clusters or segments, a line can be drawn perpendicular to the x-axis of the graph at the point where the number of linkages is equal to the number of desired segments. For example, for a  $k = 5$  cluster solution, the clusters are as follows:

1. Indianapolis, IN; Madison, WI; Poughkeepsie, NY; Providence, RI
2. Atlanta, GA; Chicago, IL, Detroit, MI; Houston, TX; Riverside, CA; Seattle, WA;  
Washington, DC
3. Boston, MA; Columbus, OH; Dallas, TX; Miami, FL; Minneapolis, MN; Philadelphia,  
PA
4. Bridgeport, CT; San Francisco, CA; San Jose, CA
5. Los Angeles, CA; New York, NY

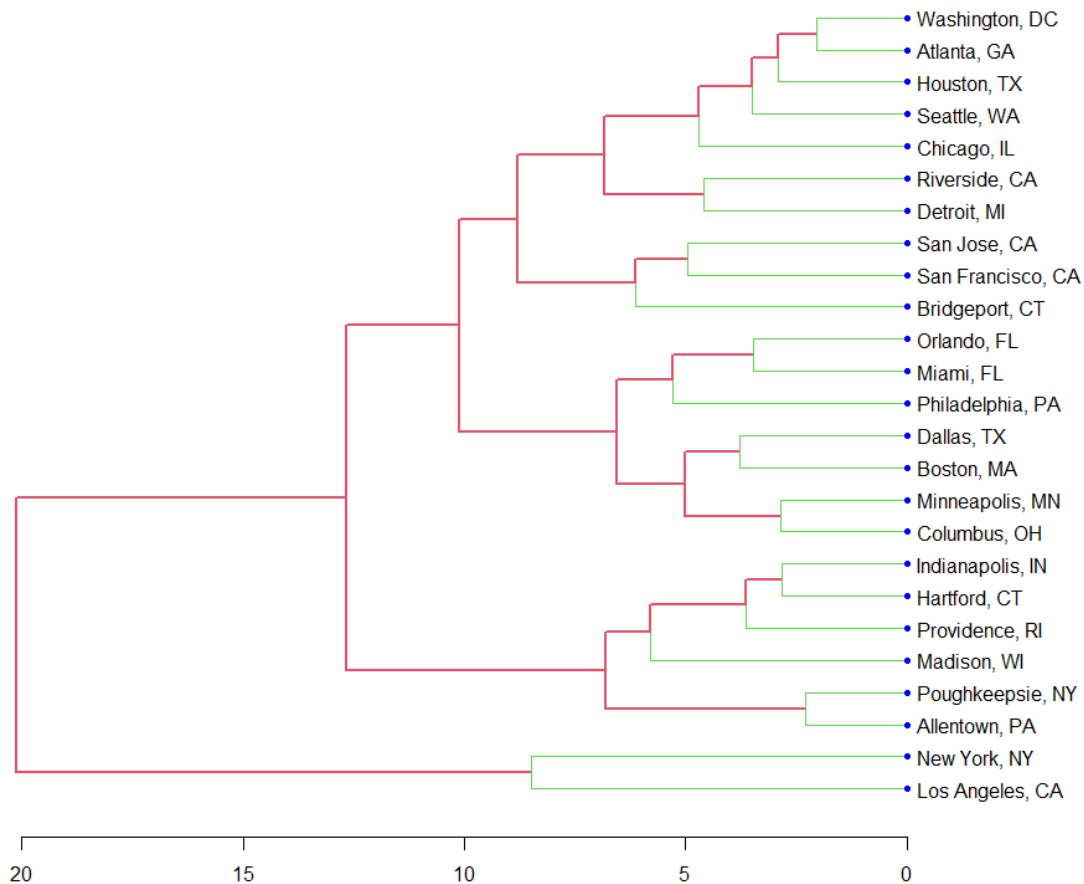

Figure 2.34. Cluster Analysis using Ward's Method of top 25 Metros.

To conclude the analysis, standardized values were calculated for the first “market potential” dimension by subtracting the mean value and dividing by the standard deviation. The values were color-coded and summarized in Figure 2.35. Taking the Top 10 items, the index agrees with the final SSA index on eight out of the ten metro areas, including Washington, DC and Chicago, IL, rather than Columbus, OH and Orlando, FL. This is probably because the first factor in the PCA solution is loaded on the market factors, but that some of the readiness metrics are negatively loaded as these tend to be higher in small markets. This indicates that some of the infrastructure/per capita metrics may be skewed towards smaller metro areas. In addition, there are some definite disadvantages of larger metro areas with respect to UAM, such as air congestion and Class B airspace. Thus, a more qualitatively generated weighting scheme incorporating these factors is appropriate.

Name	MP	Name	MP	Name	MP	Name	MP
New York, NY	5.221	Providence, RI	0.323	Indianapolis, IN	-0.293	Louisville, KY	-0.662
Los Angeles, CA	3.599	Charlotte, NC	0.283	Memphis, TN	-0.296	Chattanooga, TN	-0.680
San Francisco, CA	2.266	Modesto, CA	0.278	Richmond, VA	-0.306	Dayton, OH	-0.691
Chicago, IL	1.940	Phoenix, AZ	0.271	Buffalo, NY	-0.313	Omaha, NE	-0.703
Miami, FL	1.569	Cleveland, OH	0.254	Greenville, SC	-0.318	Rochester, NY	-0.738
San Jose, CA	1.545	Columbus, OH	0.185	Charleston, SC	-0.324	Columbia, SC	-0.745
Washington, DC	1.527	New Haven, CT	0.143	Salt Lake City, UT	-0.341	Des Moines, IA	-0.750
Boston, MA	1.494	Sacramento, CA	0.073	Worcester, MA	-0.363	Albuquerque, NM	-0.770
Bridgeport, CT	1.428	Stockton, CA	0.053	Greensboro, NC	-0.429	Bakersfield, CA	-0.781
Dallas, TX	1.378	Milwaukee, WI	0.034	Albany, NY	-0.432	Knoxville, TN	-0.783
Philadelphia, PA	1.238	St. Louis, MO	0.021	Poughkeepsie, NY	-0.463	Harrisburg, PA	-0.783
Houston, TX	1.191	Austin, TX	0.018	El Paso, TX	-0.466	Lakeland, FL	-0.796
Detroit, MI	1.150	Raleigh, NC	0.012	Grand Rapids, MI	-0.478	Syracuse, NY	-0.814
Seattle, WA	1.057	Las Vegas, NV	-0.033	Akron, OH	-0.498	Toledo, OH	-0.832
Atlanta, GA	0.863	New Orleans, LA	-0.034	McAllen, TX	-0.519	Provo, UT	-0.850
Honolulu, HI	0.805	Hartford, CT	-0.066	Palm Bay, FL	-0.535	Augusta, GA	-0.871
Minneapolis, MN	0.768	Nashville, TN	-0.071	Tucson, AZ	-0.545	Little Rock, AR	-0.896
Orlando, FL	0.737	Portland, OR	-0.103	Ogden, UT	-0.549	Madison, WI	-0.947
Riverside, CA	0.593	Cincinnati, OH	-0.124	Fresno, CA	-0.603	Jackson, MS	-0.959
Tampa, FL	0.588	Kansas City, MO	-0.141	Oklahoma City, OK	-0.610	Scranton, PA	-0.997
Baltimore, MD	0.587	Lancaster, PA	-0.193	Colorado Springs, CO	-0.635	Tulsa, OK	-1.004
Denver, CO	0.585	San Antonio, TX	-0.209	Birmingham, AL	-0.644	Boise City, ID	-1.126
San Diego, CA	0.561	Cape Coral, FL	-0.218	Allentown, PA	-0.648	Baton Rouge, LA	-1.132
Oxnard, CA	0.479	Jacksonville, FL	-0.263	North Port, FL	-0.649	Wichita, KS	-1.206
Pittsburgh, PA	0.328	Virginia Beach, VA	-0.268	Springfield, MA	-0.653	Youngstown, OH	-1.294

Figure 2.35. Summary of Factor 1 Market Potential Values.

Overall, the analyses in this section have generated a high degree of insight into the components of the SSA index. The correlation charts and box plots showed how the different values of the index relate to one another and co-vary with one another. Most of the factors are positively correlated with the overall population and economic power of the metropolitan area. However, several of the readiness factors are negatively correlated with the overall market power, indicating a trade-off between factors that make large metropolitan areas attractive, and factors that cause difficulties, such as the presence of Class B airspace.

The PCA built on the previous analyses and found a single factor incorporating most market power characteristics. After rotation, this index provides good face validity and agreement with the final SSA index. However, it does have negative loading on some of the infrastructure variables, as the airports per capita, heliports per capita, and Class B airspace are negatively loaded on this dimension. The Class B airspace factor is definitely a negative indicator for larger metros, though it may be that for larger metros the raw number of airports and heliports is as important as the “per capita” figures, as for large, diverse metros such as New York City and Los Angeles, having relatively fewer locations with higher passenger numbers may be advantageous for UAM development.

In a more general sense, the analyses in this section also showed how segmentation techniques can be used to group or cluster markets and how given a successful market providers can pick markets with similar characteristics using segmentation methods. This type of analysis was demonstrated using hierarchical clustering with Ward’s methods, but a range of clustering methods including



tree-generating hierarchical methods, partitioning methods that create segments directly, and fuzzy/overlapping methods could be employed.

### **2.6.1 Site Suitability Analysis: Psychometric Validation - Additional References**

- Dunteman, G. H. (1989). *Principal components analysis* (No. 69). Sage.
- Gabriel, K. R. (1971). The biplot graphic display of matrices with application to principal component analysis. *Biometrika*, 58(3), 453-467.
- Gower, J. C., Lubbe, S. G., & Le Roux, N. J. (2011). *Understanding biplots*. John Wiley & Sons.
- Grubestic, T. H., & Wei, F. (2012). Evaluating the efficiency of the Essential Air Service program in the United States. *Transportation Research Part A: Policy and Practice*, 46(10), 1562-1573.
- Hall, J., Ross, A., & Yench, C. (2015). The political economy of the Essential Air Service program. *Public Choice*, 165(1), 147-164.
- Jackson, D. A. (1993). Stopping rules in principal components analysis: A comparison of heuristical and statistical approaches. *Ecology*, 74(8), 2204-2214.
- Jennrich, R. I. (1970). Orthogonal rotation algorithms. *Psychometrika*, 35(2), 229-235.
- Kaiser, H. F. (1958). The varimax criterion for analytic rotation in factor analysis. *Psychometrika*, 23(3), 187-200.
- Kale, S. H., & Sudharshan, D. (1987). A strategic approach to international segmentation. *International Marketing Review*, 4(2), 60-70.
- Murtagh, F., & Legendre, P. (2014). Ward's hierarchical agglomerative clustering method: which algorithms implement Ward's criterion?. *Journal of Classification*, 31(3), 274-295.
- Shlens, J. (2014). A tutorial on principal component analysis. arXiv preprint arXiv:1404.1100.
- Ward Jr, J. H. (1963). Hierarchical grouping to optimize an objective function. *Journal of the American Statistical Association*, 58(301), 236-244.
- Wind, Y., & Douglas, S. P. (1972). International market segmentation. *European Journal of Marketing*, 6(1), 17-25.
- Zhu, M., & Ghodsi, A. (2006). Automatic dimensionality selection from the scree plot via the use of profile likelihood. *Computational Statistics & Data Analysis*, 51(2), 918-930.

### 2.6.2 Appendix: Suitability Scenario Results

In all scenarios except the Base Scenario, the five variable categories are assigned weights of 45 percent, 25 percent, 15 percent, 10 percent, and 5 percent, approximating the rank order centroid values for variable ranks one through five (45.7 percent, 25.7 percent, 15.7 percent, 9.0 percent, and 4.0 percent) (Goodwin & Wright, 2003). The rank one category reflects the general focus of the scenario. In all scenarios except one, the readiness scenario is given the second rank, as variables in this category tend to be negatively correlated with variables in other categories and therefore provides the primary constraint on the category of focus. Table 2.33 summarizes the variable and category weights for each scenario. The results of each Scenario are provided in Table 2.34.

Table 2.33. Suitability Variable Weighting for Additional Scenarios.

Category	Variable	Urban Structure		Economic Scale		Cong & Com Stress		Infr. Readiness		Exist. Short-Haul					
		Cat.	Var.	Cat.	Var.	Cat.	Var.	Cat.	Var.	Cat.	Var.				
<b>Urban Structure</b>	Population Density	45.0	22.5	10.0	5.0	15.0	7.5	15.0	7.5	10.0	5.0				
	Polycentrism		22.5									5.0	7.5	5.0	
<b>Economic Scale</b>	Fortune 1000 Presence	10.0	5.0	45.0	22.5	10.0	5.0	10.0	5.0	25.0	12.5				
	GDP per Capita		5.0									22.5	5.0	12.5	
<b>Congestion</b>	Average Time to Work	15.0	5.0	15.0	5.0	45.0	15.0	25.0	8.3	5.0	1.7				
	Travel Time Index		5.0									5.0	15.0	8.3	1.7
	Airport to CBD Drive Time		5.0									5.0	15.0	8.3	1.7
<b>Readiness</b>	Heliports per Capita	25.0	5.0	25.0	5.0	25.0	5.0	45.0	9.0	15.0	3.0				
	Airports per Capita		5.0									5.0	5.0	9.0	3.0
	Class B Airspace		5.0									5.0	5.0	9.0	3.0
	Class G Airspace Congestion		5.0									5.0	5.0	9.0	3.0
	Public & Private Investment		5.0									5.0	5.0	9.0	3.0
<b>Existing Demand</b>	Airport Short-Haul OD <150 Miles	5.0	5.0	5.0	5.0	5.0	5.0	5.0	5.0	45.0	45.0				

Table 2.34. Additional Suitability Scenario Results.

	Total Population	Urban Structure		Economic Scale		Congestion			Readiness					Existing Demand	
		US1: Population Density	US2: Polycentrism	ES1: Fortune 1000 Presence	ES2: GDP per Capita	C1: Average Time to Work	C2: Travel Time Index	C3: Airport to CBD Drive Time	R1: Heliports per Capita	R2: Airports per Capita	R3: Class B Airspace	R4: Class G Airspace Congestion	R5: Public & Private Investment	ED1: Airport Short Haul OD <150 Miles	
<i>Total Population</i>	1.00														
<b>Urban Structure</b>	US1: Population Density	0.73	1.00												
	US2: Polycentrism	0.69	0.60	1.00											
<b>Economic Scale</b>	ES1: Fortune 1000 Presence	0.90	0.69	0.48	1.00										
	ES2: GDP per Capita	0.38	0.45	0.20	0.58	1.00									
<b>Congestion</b>	C1: Average Time to Work	0.63	0.61	0.41	0.60	0.41	1.00								
	C2: Travel Time Index	0.51	0.56	0.39	0.49	0.33	0.56	1.00							
	C3: Airport to CBD Drive Time	0.50	0.51	0.33	0.49	0.30	0.55	0.45	1.00						
<b>Readiness</b>	R1: Heliports per Capita	-0.06	-0.07	-0.03	-0.06	-0.06	0.06	-0.17	-0.09	1.00					
	R2: Airports per Capita	-0.33	-0.49	-0.31	-0.31	-0.25	-0.49	-0.35	-0.39	0.16	1.00				
	R3: Class B Airspace	-0.58	-0.45	-0.43	-0.56	-0.35	-0.45	-0.30	-0.29	-0.02	0.34	1.00			
	R4: Class G Airspace Congestion	-0.18	-0.47	-0.08	-0.14	-0.02	-0.37	-0.16	-0.20	-0.14	0.25	0.14	1.00		
	R5: Public & Private Investment	0.64	0.51	0.38	0.59	0.28	0.36	0.37	0.30	-0.03	-0.17	-0.34	-0.25	1.00	
<b>Existing Demand</b>	ED1: Airport Short Haul OD <150 Miles	0.93	0.76	0.62	0.82	0.37	0.63	0.43	0.49	-0.03	-0.35	-0.44	-0.27	0.64	1.00

## 2.7 Appendix C: Code for Bass Modeling

This section contains code and a modeling spreadsheet description for the Bass Modeling spreadsheet. Links to the files are given below.

[BassModelEstimates.R](#) – This spreadsheet contains the code for creating the Bass model estimates. The code is also listed below.

[AllCities.csv](#) – A csv file containing the yearly demand data collated for the site suitability analysis, which is used for demand estimates and to get estimates of Bass parameters.

[SSAExportMatch.csv](#) – A csv file containing the suitability characteristics for the site suitability analysis and used in predictions/validation of Bass parameters.

[AllDiffusionCurvesV2.xlsm](#) – A spreadsheet and associated macro for combining different forecasts and delaying different forecasts.

The remainder of this section contains the following:

- The R code (along with detailed comments) for analyzing demand data using Bass modeling.
- An overview of the spreadsheet for merging and combining estimates
- VBA code for merging the estimates.

### 2.7.1 R Code for Bass Modeling

```
#BassModelEstimates.R
```

```
#This contains the R code for the diffusion modeling section of the A36 project
```

```
#Written by Stephen L. France 2022: sfrance@business.msstate.edu
```

```
#Create a series of demand estimates for overall demand data.
```

```
if (!require("forecast")) install.packages("forecast")
```

```
library(forecast)
```

```
if (!require("diffusion")) install.packages("diffusion")
```

```
library(diffusion)
```

```
if (!require("tidyverse")) install.packages("tidyverse")
```

```
library(tidyverse)
```

```
if (!require("viridis")) install.packages("viridis")
```

```
library(viridis)
```

```
if (!require("ggplot2")) install.packages("ggplot2")
```

```
library(ggplot2)
```

```
if (!require("gtable")) install.packages("gtable")
```

```
library(gtable)
```

```
if (!require("boot")) install.packages("boot")
```

```
library(boot)
```

```
if (!require("sjPlot")) install.packages("sjPlot")
```

```

library(sjPlot)

setwd("~/R/FAA") #Need to set to actual working directory
source("DemandEstimate.R")
source("DistFunctions.R")

#####
#Section A: Loading/Cleaning the data
#####

#First load in the data files for the major postal sources
setwd("~/R/FAAMovingVehicles")

#Find bass parameters for the estimates
AllCities<-read.csv("AllCities.csv",header=TRUE)

#Remove bad rows
AllCities<-AllCities[apply(is.na(AllCities),1,"sum")==0,]
n<-nrow(AllCities)
m<-ncol(AllCities)
#The input data included commas, which threw R. The code below corrects this issue.
NumericCols<-c(2,4:m)
AllCities[,NumericCols]
AllCities[,NumericCols]<-
lapply(AllCities[,NumericCols],function(x){as.numeric(gsub(","," ",x))})

#####
#Section B: Creating Bass Model estimates
#####

#Create bass estimates
Results<-matrix(0,nrow=n,ncol=6)

#Iterate through each of the cities
for (i in 1:nrow(AllCities))

```

```

{
  #Ensure that the data are numeric
  YrTrips<-as.numeric(AllCities[i,4:(m-1)])
  #The diffusion function takes increases
  YrTripsIncrease<-YrTrips-c(0,YrTrips[-length(YrTrips)])
  #We fit Bass + Gompertz, but ultimately only use Gompertz
  out.bass<-diffusion(x=YrTripsIncrease,type="bass")
  out.gompertz<-diffusion(x=YrTripsIncrease,type="gompertz")
  Results[i,1:3]<-out.bass$w
  Results[i,4:6]<-out.gompertz$w
}

#Create data frame of estimates
Resultsdf<-data.frame(AllCities[,3],Results)
colnames(Resultsdf)<-
c("City","BasspIn","BassqIm","Bassm","GomppDisp","GomppGro","Gompm")

#####
#Section C: Examine and Create Overall Distributions for Bass Model Parameters
#####

#Create a density plot for estimates
ggplot(Resultsdf, aes(x=BasspIn)) +
  geom_histogram(aes(y=..density..),      # Histogram with density instead of count on
y-axis
              binwidth=.5,
              colour="black", fill="white") +
  geom_density(alpha=.2, fill="#FF6666") # Overlay with transparent density plot

#Quirk of the bootstrap function, I need to create a wrapper for the mean function to
pass to boot!
mean.fun <- function(data, idx)
{
  df <- data[idx]

  # Find the spearman correlation between

```

```

# the 3rd and 4th columns of dataset
c(mean(df))
}

#Create Bootstrap samples for overall Bass parameters across cities.
#The idea here is that there is some damping effect and some noise in estimates
#It is likely that using individual city estimates will overfit, but using aggregate
sensistive enough
temp_boot<-boot(Resultsdf[,"BasspIn"],statistic=mean.fun,R=1000)
BasspInCI<-boot.ci(temp_boot,conf = 0.99, type = "perc")
temp_boot<-boot(Resultsdf[,"BassqIm"],statistic=mean.fun,R=1000)
BassqImCI<-boot.ci(temp_boot,conf = 0.99, type = "perc")
temp_boot<-boot(Resultsdf[,"GomppDisp"],statistic=mean.fun,R=1000)
GomppDispCI<-boot.ci(temp_boot,conf = 0.99, type = "perc")
temp_boot<-boot(Resultsdf[,"GompqGro"],statistic=mean.fun,R=1000)
GompqGroCI<-boot.ci(temp_boot,conf = 0.99, type = "perc")

#Now create different estimates
Resultsdf<-data.frame(AllCities[,3],Results)
colnames(Resultsdf)<-
c("City","BasspIn","BassqIm","Bassm","GomppDisp","GompqGro","Gompm")

SmoothedCurve<-AllCities
MedianCurve<-AllCities
LowpLowqCurve<-AllCities
LowpHighqCurve<-AllCities
HighpLowqCurve<-AllCities
HighpHighqCurve<-AllCities
Medianpq<-c(0.001326092,0.1770338)
LowpLowq<-c(0.0009456528,0.159998)
LowpHighq<-c(0.0009456528,0.1965008)
HighpLowq<-c(0.00175723,0.159998)
HighpHighq<-c(0.00175723,0.1965008)

#####
#Section C: Predictors of diffusion parameters using site suitability data

```

```
#####

#Load in the site suitability dataset. There are a few cities that are on the demand
dataset
#and not on the Site Suitability Analysis dataset and vice-versa, so we need to match.
SSAExportMatch<-read.csv("SSAExportMatch.csv",header=TRUE)

#Now match with the results
MatchedRes<-cbind(Resultsdf,SSAExportMatch)
MatchedRes<-MatchedRes[!is.na(MatchedRes$US1),]

#Get a dataset for predicting the Bass p parameter
BasspReg<-MatchedRes[,c(2,10,11,13,15,17,19,21,23,25,27,29,30,32,33)]
BasspReg$R3_Stand<-as.factor(BasspReg$R3_Stand)
#To give reasonable estimates (i.e., coefficients are not 0.000), multiply by 1000
BasspReg$BasspIn<-BasspReg$BasspIn*1000
#Create a base model (only predictor is the intercept) and
BaseModel<-lm(BasspIn~1,data=BasspReg)
FullModel<-lm(BasspIn~.,data=BasspReg)

#Create a stepwise regression model to optimize model with respect to number of
parameters.
StepModelp<-step(BaseModel, scope=list(lower=BaseModel, upper=FullModel),
direction="forward")
summary(StepModelp)
tab_model(StepModelp,file = "StepModelp.html")

#Test model for multicollinearity
if (!require("olsrr")) install.packages("olsrr")
library(olsrr)
ols_vif_tol(StepModelp)
par(mfrow=c(2,2)) #set screen up for 4 plots
plot(StepModelp)

#Get a dataset for predicting the Bass q parameter
BassqReg<-MatchedRes[,c(3,10,11,13,15,17,19,21,23,25,27,29,30,32,33)]
```



```

#Create model to predict Bass q parameters (as before)
BassqReg$BassqIm<-BassqReg$BassqIm*100
BassqReg$R3_Stand<-as.factor(BassqReg$R3_Stand)
BaseModel<-lm(BassqIm~1,data=BassqReg)
FullModel<-lm(BassqIm~.,data=BassqReg)
StepModelq<-step(BaseModel,          scope=list(lower=BaseModel,          upper=FullModel),
direction="forward")
summary(StepModelq)
tab_model(StepModelq,file = "StepModelq.html")

if (!require("olsrr")) install.packages("olsrr")
library(olsrr)
ols_vif_tol(StepModelq)
par(mfrow=c(2,2)) #set screen up for 4 plots
plot(StepModelp)

#Get a dataset for predicting the Bass m parameter
BassmReg<-MatchedRes[,c(4,10,11,13,15,17,19,21,23,25,27,29,30,32,33)]
#Create model to predict Bass m parameters (as before)
BassmReg$R3_Stand<-as.factor(BassmReg$R3_Stand)
BaseModel<-lm(BassqIm~1,data=BassmReg)
FullModel<-lm(BassqIm~.,data=BassmReg)
StepModelm<-step(BaseModel,          scope=list(lower=BaseModel,          upper=FullModel),
direction="forward")
summary(StepModelm)
tab_model(StepModelm,file = "StepModelm.html")

if (!require("olsrr")) install.packages("olsrr")
library(olsrr)
ols_vif_tol(StepModelm)
par(mfrow=c(2,2)) #set screen up for 4 plots
plot(StepModelm)

#####
#Section D: Create diffusion estimate for each city
#####

```

```

for (i in 1:nrow(AllCities))
{
  YrTrips<-as.numeric(AllCities[i,4:(m-1)])
  YrTripsIncrease<-YrTrips-c(0,YrTrips[-length(YrTrips)])
  NoPeriods<-length(YrTrips)
  out.bass<-diffusion(x=YrTripsIncrease,type="bass")
  Tempw<-out.bass$w
  #The actual data curve, but smoothed using the Bass parameters
  SmoothedCurve[i,4:(m-1)]<-difcurve(n=NoPeriods,curve=out.bass)[,1]
  #Using median p,q across all cities
  MedianCurve[i,4:(m-1)]<-difcurve(n=NoPeriods,type="bass",w=c(Medianpq,Tempw[3]))
  #Using the different extremes from the 95% confidence intervals
  LowpLowqCurve[i,4:(m-1)]<-
difcurve(n=NoPeriods,type="bass",w=c(LowpLowq,Tempw[3]))[,1]
  LowpHighqCurve[i,4:(m-1)]<-
difcurve(n=NoPeriods,type="bass",w=c(LowpHighq,Tempw[3]))[,1]
  HighpLowqCurve[i,4:(m-1)]<-
difcurve(n=NoPeriods,type="bass",w=c(HighpLowq,Tempw[3]))[,1]
  HighpHighqCurve[i,4:(m-1)]<-
difcurve(n=NoPeriods,type="bass",w=c(HighpHighq,Tempw[3]))[,1]
}

#Write to the current working directory
write.csv(SmoothedCurve,"SmoothedCurve.csv")
write.csv(MedianCurve,"MedianCurve.csv")
write.csv(LowpLowqCurve,"LowpLowqCurve.csv")
write.csv(LowpHighqCurve,"LowpHighqCurve.csv")
write.csv(HighpLowqCurve,"HighpLowqCurve.csv")
write.csv(HighpHighqCurve,"HighpHighqCurve.csv")

```

### 2.7.2 Overview of Data Merge Spreadsheet (*AllDiffusionCurvesV2.xlsm*)

The Spreadsheet for Merging the estimates has worksheets for each of the different source estimates. The Spreadsheet is “general”, but in the submitted spreadsheet the estimates are the ones created in the Bass Modeling R Code.

A description of each of the subsheets is given below:

- OriginalData – The original demand data from the site suitability analysis
- SmoothedCurve – The smoothed demand data, calculated by using Bass Model predictions using the individual city p, q, and m.
- MedianpqCurve – Forecasts for each city using the m for each city, but median p and q from the bootstrapping distribution confidence intervals (CIa).
- LowpLowqCurve – Forecasts for each city using the m for each city, but the lower bounds of the 95% CI bootstrapping distribution for the parameters.
- LowpHighqCurve – As above, but lower bound of the 95% CI for p and the upper bound of the 95% CI for q.
- HighpLowqCurve – As above, but upper bound of the 95% CI for p and the lower bound of the 95% CI for q.
- HighpHighqCurve – As above, but upper bound of the 95% CI for p and the upper bound of the 95% CI for q.
- LosAngelesCS, LosAngelesCS2 – Figures from the report case study for Los Angeles.
- Run – This sheet contains the macro for the combined estimates. This sheet is explained in more detail in the Figure below.

	A	B	C	D	E	F	G
1	<b>Control Panel</b>						
2	Proportion Delay	1					
3	Info Columns	4					
4							
5	<b>Curve Mixture</b>						
6	OriginalData						
7	SmoothedCurve	1					
8	MedianpqCurve						
9	LowpLowqCurve						
10	LowpHighqCurve						
11	HighpLowqCurve						
12	HighpHighqCurve						
13							

Figure 2.36: The Run Sheet Macro

The sheet has two sections. The first contains control parameters and the second contains the mixture proportions for the different sheets.

- Proportion Delay: This is due to the fact that raw demand estimates are from the current year, but implementation dates are later. A value of 1 moves back the first (in this case 2022) estimates to the estimated start year for the city (e.g., if a metro is estimated to start in 2028 the estimates are moved back six years). A value of 0 gives the estimate for that particular year (e.g., for a city starting in 2028 this will be the actual 2028 value). Any value between 0 and 1 gives a weighted sum of these values.
- Info Columns: This gives the number of information columns before the start of the estimates. The date should be in the **last info column** (here column 4). This should be followed by yearly demand estimates.
- Curve mixture: This allows a mix of different estimates. All of these estimates (in Figure 2.36 this is the cells B6:B12 should add up to 1).

- Run: Selecting the run button creates a new composite estimate from the other worksheets.

### 2.7.3 Data Merge Spreadsheet VBA Code (from Run Button)

'Standard VBA options for explicitly declaring variables, arrays with base 0, and making text comparisons of strings

Option Explicit

Option Base 0

Option Compare Text

Private mCurveDic As Dictionary

Private mwsOutput As Worksheet

Private mwsInput As Worksheet '

Private mPropDelay As Double 'The proportion of revenue 'delayed', i.e. from the first year estimated (which for the data in this project is 2022

Private mYearCol As Long 'The column in the data spreadsheets that correspond to the start year

Private Sub cmdRun\_Click()

Dim CurRow As Long

Dim SheetName As String, SheetProp As String, SheetPropVal As Double, CurValue As Double

Dim ColText As String

Dim wsCounter As Long, RowCounter As Long, ColCounter As Long

Dim StartYear As Long, FirstYear As Long, CurYear As Long

'Get the delay proportion and the year columns

mPropDelay = CDBl(Trim\$(Cells(2, 2).Text))

mYearCol = CLng(Trim\$(Cells(3, 2).Text))

'Create a dictionary to include the different proportion of demand to be created from each of the sheets.

Set mCurveDic = New Dictionary

CurRow = 6

SheetName = Trim\$(Cells(CurRow, 1).Text)

Do While SheetName <> ""

SheetProp = Trim\$(Cells(CurRow, 2).Text)

If IsNumeric(SheetProp) Then

```

        mCurveDic.Add Key:=SheetName, Item:=SheetProp
    End If
    CurRow = CurRow + 1
    SheetName = Trim$(Cells(CurRow, 1).Text)
Loop

'Create the output sheet
Set mwsOutput = ThisWorkbook.Worksheets.Add

'Now go through the process of adding each forecast value
For wsCounter = 0 To mCurveDic.Count - 1
    SheetName = mCurveDic.Keys(wsCounter)
    SheetPropVal = mCurveDic.Items(wsCounter)
    Set mwsInput = ThisWorkbook.Worksheets.Item(SheetName)
    'If the first workbook then copy over the columns
    If wsCounter = 0 Then
        ColText = Chr(65) + ":" + Chr(64 + mYearCol)
        mwsInput.Columns(ColText).Copy mwsOutput.Columns(ColText)
        mwsInput.Rows(1).Copy mwsOutput.Rows(1)
    End If

    RowCounter = 2
    'Go through each city in turn
    Do While Trim$(mwsInput.Cells(RowCounter, 1).Text) <> ""
        StartYear = CLng(Trim$(mwsInput.Cells(RowCounter, mYearCol).Text))
        ColCounter = mYearCol + 1
        FirstYear = CLng(Trim$(mwsInput.Cells(1, ColCounter).Text))
        'Go through each time period in turn
        Do While Trim$(mwsInput.Cells(1, ColCounter) <> "")
            DoEvents
            'If there is no estimate then set the contribution to be 0
            If Trim$(mwsOutput.Cells(RowCounter, ColCounter).Text) = "" Then

```

```

    mwsOutput.Cells(RowCounter, ColCounter).Value = 0
End If
CurYear = CLng(Trim$(mwsInput.Cells(1, ColCounter).Text))
'If we are after the estimated start year for the city then build estimates
If CurYear >= StartYear Then
    CurValue = CDb(Trim$(mwsOutput.Cells(RowCounter, ColCounter).Text))
    'Take the (1-proportion of delay value) for the current year
    CurValue = CurValue + SheetPropVal * (1 - mPropDelay) *
Cdbl(Trim$(mwsInput.Cells(RowCounter, ColCounter).Text))
    'Take the (proportion of delay value) for the year relative to the start of
the estimates
    CurValue = CurValue + SheetPropVal * mPropDelay *
Cdbl(Trim$(mwsInput.Cells(RowCounter, ColCounter - (StartYear - FirstYear)).Text))
    mwsOutput.Cells(RowCounter, ColCounter).Value = CurValue
End If
    ColCounter = ColCounter + 1
Loop
    RowCounter = RowCounter + 1
Loop
Next

MsgBox "Finished", vbExclamation

End Sub

```

### **3 AIRWORTHINESS REGULATIONS AND THEIR APPLICABILITY TO UAM AIRCRAFT CERTIFICATION**

Safety is a fundamental condition for UAM activities to be accepted by regulators, users, and the general public. The use of UAM aircraft to transport passengers will require a certification process that leverages additional or different technical requirements to what is covered with current 14 CFR Part 23 or 27 type certification requirements for fixed-wing or rotorcraft. These aircraft have non-conventional architectures, single or distributed electric propulsion, complex battery systems, autonomous flight, noise, etc.

To understand the potential certification differences between conventional and UAM aircraft, first, a detailed UAM classification was conducted. This classification provides information about the different UAM architectures considered and the specific design characteristics of each aircraft (see Section 3.1). This data is analyzed to understand trends and document the main differences between UAM architectures. Subsequently, the current established and proposed airworthiness standards and requirements are studied and evaluated. Due to the broad scope of work and the different disciplines involved in the certification of an aircraft, at the beginning of the program, the FAA identified three specific areas with higher priority; Crashworthiness (see Section 3.2.2), Battery Crashworthiness (see Section 3.2.3) and Noise ( see Section 3.2.4).

In addition, due to the novelty of UAM aircraft, one of the main gaps in knowledge involves the potential rigor, oversight, and costs to streamline the certification process. NIAR leveraged General Aviation (GA) industry organizations' past and current cost analysis for certification of similar aircraft attributes, implemented in UAM aircraft design and production processes. This research attempted to conduct a cost analysis for the certification of a UAM aircraft (Section 3.3).

The present section aims to answer the following research questions, to bridge the knowledge gaps about the novelty of the UAM market:

- a) Can we classify UAM by categories in terms of airworthiness? What will these categories look like?
- b) Are current regulatory frameworks for conventional aircraft vehicles applicable?
- c) What framework is needed to regulate the airworthiness of UAM vehicles?
- d) Can a reliable estimate for certification costs be projected for UAM vehicles?

#### **3.1 Task I – UAM Classification**

Before analyzing the data in this section, it is essential to clearly understand the definitions of UAM and UAM aircraft. According to the FAA, UAM is “a safe and efficient aviation transportation system that will use highly automated aircraft that will operate and transport passengers or cargo at lower altitudes within urban and suburban areas.” By this definition, any aircraft that flies at higher altitudes and is not highly automated is generally not considered a part of the UAM system.

From the FAA definition, it is not clear what constitutes a UAM vehicle besides the fact that it needs to be highly automated. Therefore, another more detailed and precise definition of a UAM vehicle is necessary to improve the quality of data analysis by identifying and filtering out the non-

UAM vehicle data. The following definition from the report by Rizzi et al. provides a better description of a UAM vehicle.

*“While not strict definitions, representative UAM vehicles attributes include electrical vertical takeoff and landing (eVTOL) vehicles that can accommodate up to 6 passengers (or equivalent cargo), are possible autonomous, perform missions of up to 100 nautical miles at altitudes up to 3000 ft above ground level, have flight speeds up to 200 knots, and payloads between 800 and 8000 lbs” (Rizzi et al., 2020).*

### **3.1.1 Overall Market**

A database of the entire UAM VTOL market was generated, where the main characteristics of 212 vehicles were documented. The vehicles included in this database were extracted from the eVTOL Aircraft Directory available at [evtol.news/aircraft](http://evtol.news/aircraft). The generated database excludes any aircraft that does not fit the Rizzi definition of a UAM vehicle (Rizzi et al., 2020), is defunct, does not have any technical information, or was added after June 2021, which was the most recent update of the database at the time of writing this report. The database documented the following parameters:

- Vehicle Architecture:
  - Vectored Thrust: an aircraft that uses any of its thrusters for lift and cruise
  - Lift + Cruise: an aircraft that has independent thrusters for lifting and cruising
  - Wingless Multicopter: an aircraft that is only equipped with lifting thrusters
  - Electric Rotorcraft: an aircraft that utilizes a single lifting rotor (electric helicopter or electric autogyro)
- Vehicle mission purpose
  - Air Taxi: short-range, passenger mobility operations
  - Cargo: large-scale package delivery operations
  - Regional: long-range passenger mobility operations
  - Emergency Medical Services (EMS)
  - Personal Air Vehicle (PAV)
- Take-off and landing configuration: whether the vehicle has vertical and/or conventional take-off and landing capabilities
- Maturity: the current level of development of the vehicle, which was classified as:
  - Preliminary Design
  - Prototype Build
  - Subscale Flight Test
  - Flight Test
  - Ongoing Certification
  - Certified
  - Commercial Operation
- Autonomy level
  - Piloted: the vehicle is designed to be operated by at least one pilot onboard
  - Remotely Piloted: the vehicle is designed to be operated by a pilot on the ground
  - Autonomous: the vehicle is designed to fly autonomously
- MTOW: Maximum Take-off Weight
- Number of pilots



- Number of passengers
- Estimated pilot and passenger weight: (number of pilots + number of passengers)\*170 lb
- Payload/cargo
- Estimated total payload: estimated pilot and passenger weight + payload/cargo
- General dimensions: wingspan, length, and height
- Type of Propulsion System:
  - Electric
  - Hybrid
  - Hydrogen
  - Internal Combustion
  - Jet
- Number of lifting propellers, including tilting rotors
- Number of coaxial propeller sets
- Ducted propellers (yes or no)
- Number of forward propellers, excluding tilting rotors
- Noise:
  - Noise quietness level compared to a helicopter
  - Noise level (dB)
- Type of landing gear:
  - Tricycle, retractable
  - Tricycle, fixed
  - 4-wheels, retractable
  - 4-wheels, fixed
  - 5-wheels, fixed
  - Skids/legs
- Airframe material:
  - Composite
  - Metallic
  - Composite + Metallic
- First flight year: achieved or expected year of the first flight
- Target operation year
- Certification agency
- Certification type
- Country of origin
- Safety features:
  - Distributed Electric Propulsion (DEP)
  - Parachute
  - Redundant flight controller
  - Other features
- Control system
- Sensor types

- Performance parameters:
  - Top speed: the maximum speed as specified by the OEM
  - Maximum range: the maximum range as specified by the OEM
  - Endurance
  - Cruise Speed
  - Maximum cruise altitude (mean sea-level)
  - Maximum cruise altitude (above ground level)
  - Maximum operating altitude (mean sea-level)
  - Maximum take-off altitude (mean sea-level)
  - Maximum rate of climb
  - Maximum climb rate
- Electric propulsion system:
  - Number of electric motors
  - Motor model and type
  - Motor weight
  - Motor output (kW)
  - Number of battery packs
  - Type of battery
  - Battery power (kW) and battery energy (kWh)
  - Battery recharge time
  - Battery weight
- Jet/Internal combustion propulsion system
  - Engine model
  - Fuel type
  - Fuel capacity
  - Fuel weight
  - Engine weight
- Vehicle cost: the listing price of the vehicle as specified by the OEM

### 3.1.1.1 Overall Market Database Breakdown

The results obtained from the database are presented next. The data for each tracked parameter is presented in two charts: (1) the number of vehicles for which the tracked parameter is available and (2) the results of the tracked parameter broken down by the number of vehicles and the corresponding percentage.

#### 3.1.1.1.1 Vehicle Architecture

Figure 3.1 shows the breakdown of UAM vehicles by architecture. Out of 212 vehicles, one vehicle data was unavailable for this tracked parameter. Vehicle architectures, in order of most to least common, are vectored thrust, wingless multicopter, lift + cruise, and electric rotorcraft. The vectored thrust dominates 42% of the market, surpassing the wingless multicopter share of 26% and nearly doubling the lift + cruise share of 23%. Electric rotorcraft is the least common, with only a 9% market share. While electric rotorcraft are more conventional vehicles and, therefore, possibly easier to be certified, most manufacturers prefer a multicopter vehicle's benefits. A depiction of the main characteristics of these vehicles is shown in Figure 3.2.

### Vehicle Architecture (Complete Database)

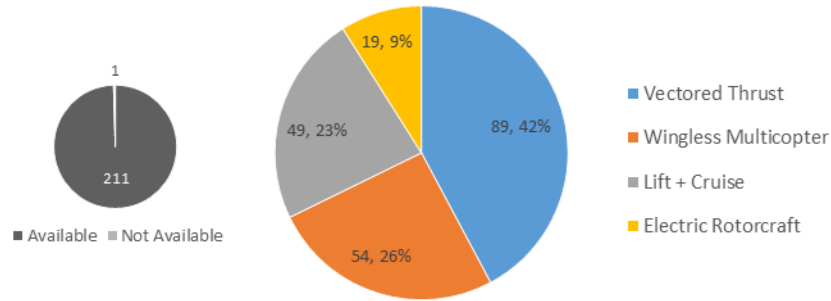

Figure 3.1. Vehicle breakdown by architecture.





Vectored Thrust	Lift + Cruise	Wingless Multicopter	Electric Rotorcraft
An aircraft that uses <b>any</b> of its thrusters for lift <b>and</b> cruise	An aircraft that has <b>independent</b> thrusters for lifting and cruising	An aircraft that is <b>only</b> equipped with <b>lifting thrusters</b>	An aircraft that utilizes a single lifting rotor (electric helicopter or electric autogyro)
			

Figure 3.2. Vehicle architecture characteristics.

#### 3.1.1.1.2 Type of Propulsion System

Figure 3.3 shows the breakdown of UAM vehicles by type of propulsion system. Out of 212 vehicles, two vehicle data were unavailable for this tracked parameter. Types of propulsion, in order from most to least common, are electric, hybrid, hydrogen, IC, and jet. The electric propulsion system dominates 57% of the market, which nearly doubles the hybrid system share of 32% and greatly surpasses the hydrogen system share of 10%. The combined market share of IC and jet systems is approximately 1%. While electric vehicles are affected in terms of range and payload compared to hybrid vehicles, there are high expectations that battery systems will keep improving. They also have some advantages over hybrids in terms of the noise produced by the vehicle. On the other hand, hybrid vehicles have a significant advantage over electric vehicles when comparing refueling and recharging times.

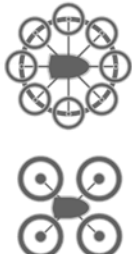
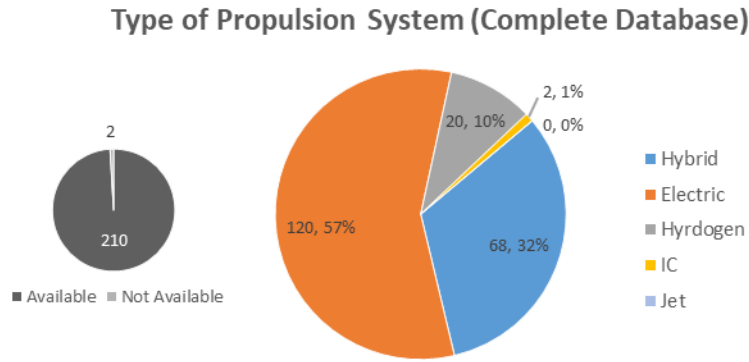

Figure 3.3. Vehicle breakdown by type of propulsion system.

### 3.1.1.1.3 Maturity Level

Figure 3.4 shows the breakdown of UAM vehicles by maturity level. Out of 212 vehicles, 83 vehicle data were unavailable for this tracked parameter. The current vehicle maturity levels, in order of most to least common, are flight test, subscale flight test, preliminary design, prototype build, ongoing certification, and certified. The first four (4) maturity levels, with the biggest difference of only 5%, occupy a combined market share of 94%. The two (2) remaining maturity levels together add up to 6%. Most vehicles in the complete database are still early in the design process. Still, about 1/3 of the vehicles have achieved the full-scale flight testing phase, and 5% of the vehicles are ongoing certification. The only vehicle that has been approved for flight is the LIFT Hexa, which has been approved under 14 CFR Part 103, conforming to the FAA's Powered Ultralight classification, for which FAA certification is not required or unavailable, as mentioned by LIFT Aircraft on its FAQ webpage (Lift Aircraft, 2021).

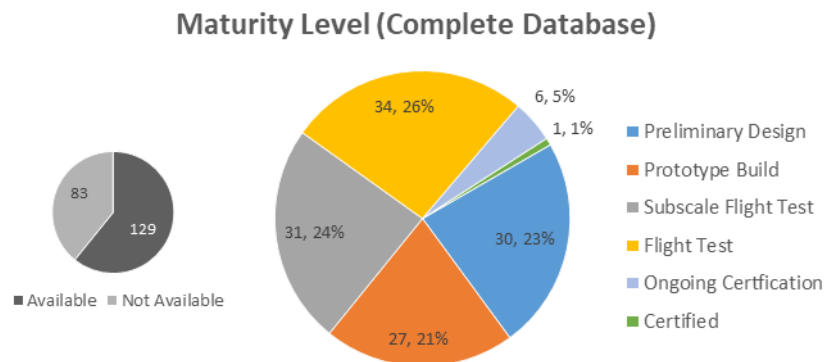

Figure 3.4. Vehicle breakdown by maturity level.

### 3.1.1.1.4 Certification Plans

Figure 3.5 shows the breakdown of UAM vehicles by the certification agency. Out of 212 vehicles, 159 vehicle data were not available for this tracked parameter. The fact that most of the vehicles do not specify which certification agency they will be working with highlights the early stage of most of these vehicles and the need for additional time before this can be defined. The planned

certification agency, in order of most to least common, are the FAA, EASA, Civil Aviation Administration of China (CAAC), and others. With a difference of only 2% between each other, FAA and EASA cover 88% of the market. On the other hand, CAAC takes 10% of the share, and other agencies make up about 2%.

Figure 3.6 provides deeper insight into the vehicles with planned or ongoing certifications under FAA (a) and EASA (b) guidelines. Out of 24 vehicles with the FAA regulatory framework, 14 vehicle data were not available for this tracked parameter. The most to the least common types for FAA certification are 14 CFR Part 23, Part 21, Part 27, Part 103, Part 29, and Light Sport Aircraft (LSA). Vehicles with planned 14 CFR Part 23 certification lead the market share with 30%, while 14 CFR Part 21, Part 27, and Part 103 have an equal distributed share of 20%. 14 CFR Part 29 takes the remaining 10% of the share, and LSA has a share of 0%. On the other hand, out of 23 vehicles with the EASA regulatory framework, 5 vehicle data were not available for this tracked parameter. The most to the least common types for EASA certification are SC-VTOL, CS-LSA, Ultralight, CS-UAS, and CS-23. Contrary to the vehicles with FAA regulatory framework, SC-VTOL has the highest market share of 67%, followed by CS-LSA at 17%. Distributed almost equally among each other, Ultralight, CS-UAS, and CS-23 claim the remaining share percentage of 16%.

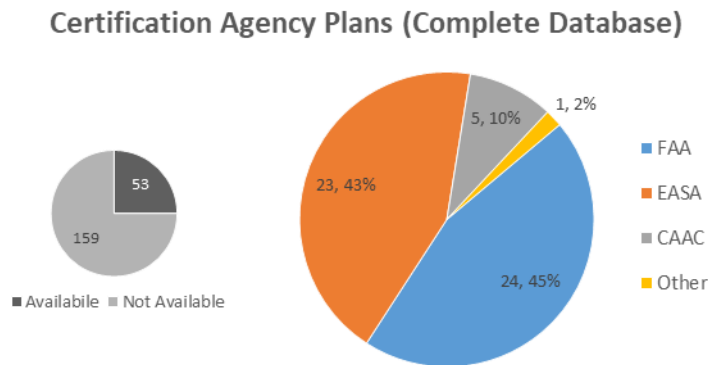

Figure 3.5. Vehicle breakdown by certification agency (planned by OEMs).

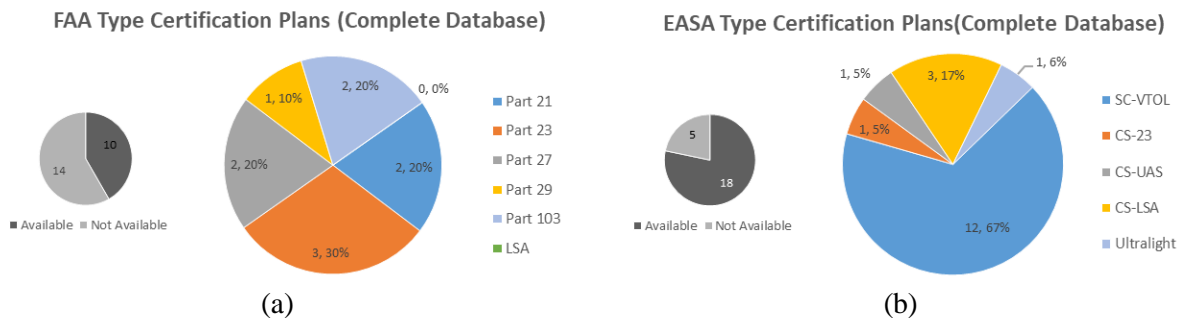

Figure 3.6. Intended section for Type Certificate by OEMs from (a) FAA and (b) EASA.

### 3.1.1.1.5 MTOW

Figure 3.7 shows the breakdown of UAM vehicles by the Maximum Takeoff Weight (MTOW). Of 212 vehicles, 84 vehicle data were unavailable for this tracked parameter. The most common maximum takeoff weight is under 2,000 lb. This frequency decreases as MTOW increases, with vehicles with an expected MTOW greater than 10,000 lb being the least common. The lowest MTOW vehicles make up 64% of the market, whereas the highest MTOW vehicles only make up 2%. In terms of noise certification, if only MTOW is considered, most vehicles would be classified as light helicopters and therefore fall under 14 CFR Part 36 Appendix J.

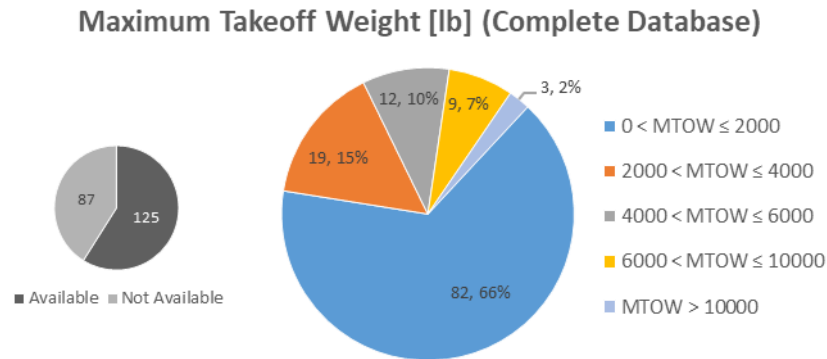
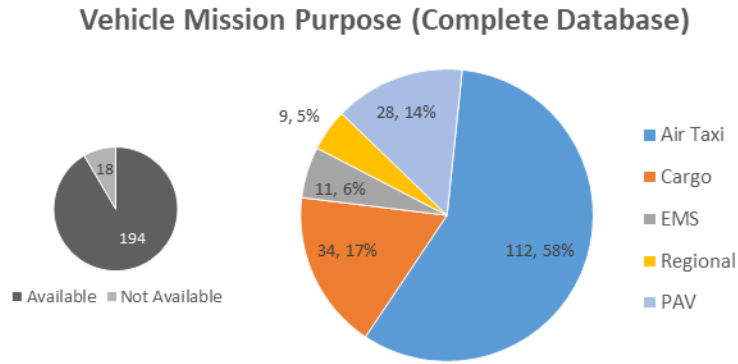

Figure 3.7. Vehicle breakdown by maximum takeoff weight (MTOW) [lb].

### 3.1.1.1.6 Mission Purpose

Figure 3.8 shows the breakdown of UAM vehicles by the primary (a) and secondary (b) missions. Out of 212 vehicles, for this tracked parameter, 18 vehicle data were unavailable for the primary mission, and 44 were unavailable for the secondary mission. In order of most to least common, the primary missions of vehicles in the database are the air taxi, cargo, PAV, EMS, and regional. On the other hand, the most to the least common secondary missions are cargo, EMS, PAV, regional, and air taxi. Based on the available information, about 25% of the vehicles studied will be multi-purpose, which means the aircraft can carry out more than one type of mission, as shown in Figure 3.8(b). Some manufacturers approach this multi-purpose by completely altering the interior of the main cabin such that there will be one fleet of vehicles for one mission type and another configuration for a different mission. Other manufacturers have designed the aircraft cabin to be modifiable by the user depending on the mission type. Another alternative proposed is a modular design; for example, a manufacturer may design the wings and rotors detachable from the main cabin and the landing gear, allowing the user to switch cabins depending on the mission. These considerations may affect the certification requirements of the aircraft.



(a)

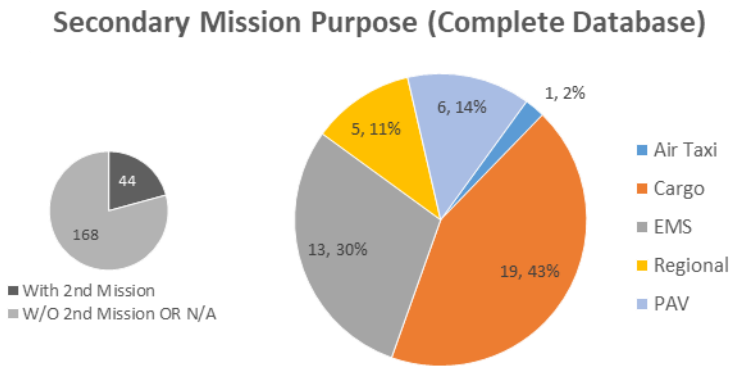

(b)

Figure 3.8. Vehicles per (a) primary and (b) secondary mission purpose.

### 3.1.1.1.7 *Autonomy Level*

Figure 3.9 shows the breakdown of UAM vehicles by the autonomy level. Out of 212 vehicles, 26 vehicle data were not available for this tracked parameter. The most to the least common autonomy levels are piloted, autonomous, and piloted remotely. The piloted vehicles dominate 54% of the market, while autonomous and piloted remotely vehicles take 41% and 5% of the market shares, respectively. While most manufacturers have chosen to design their aircraft for piloted missions, possibly due to the ease in certification, many others have planned on converting their vehicles to fully autonomous ones. That level of autonomy is highly desired amongst manufacturers since it would allow them to increase their passenger or cargo loads, increasing the potential revenue of each aircraft; however, this approach will need to be considered by regulatory agencies in the near future.

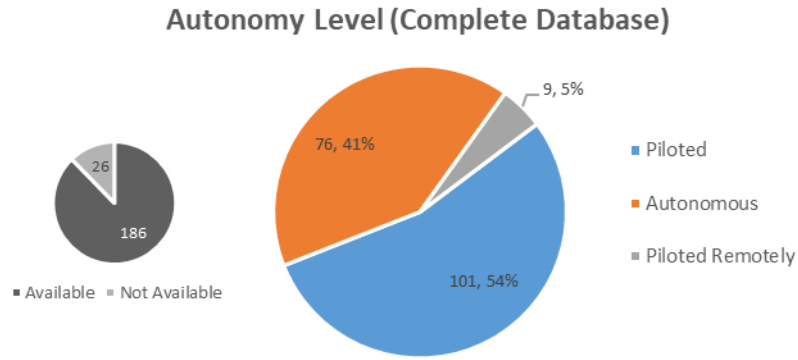

Figure 3.9. Vehicle breakdown by autonomy level.

#### 3.1.1.1.8 Estimated Total Payload

Figure 3.10 shows the breakdown of UAM vehicles by the estimated total payload. Out of 212 vehicles, 10 vehicle data were not available for this tracked parameter. The most to the least common estimated total payloads range from the order of the lightest to the heaviest. The analyzed trend shows that the lighter the payload, the more common the UAM vehicles. Vehicles with less than 500 lb payload dominate 53% of the market, followed by vehicles with less than 1000 lb payload, which take another 33%. Vehicles with payloads higher than 4000 lb see a market share of about 2%. From the vehicles with less than 500 lb payload, it is important to mention that 55% of those vehicles are either autonomous or piloted remotely, while 34% are piloted (no information available for the remaining 11%). In addition, 20% of those vehicles are reported to be used for cargo, 70% are intended for some sort of passenger transportation (air taxi, PAV, EMS, Regional), and no information was available for the remaining 10%.

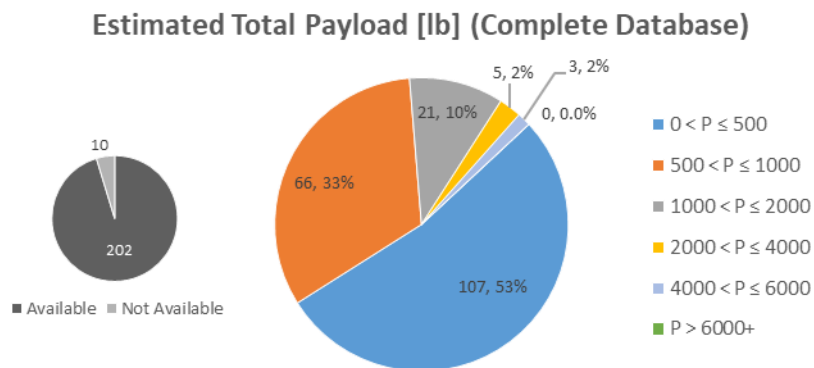

Figure 3.10. Vehicle breakdown by estimated total payload [lb].



### 3.1.1.1.9 Maximum Cruise Altitude AGL

Cruise altitude is specified in AGL since most UAM operations are expected to occur in metro areas surrounded by buildings and be relatively short in duration. Altitude in AGL makes the mission altitude somewhat independent of the sea level altitude for the operational area.

Figure 3.11 shows the breakdown of UAM vehicles by the maximum cruise altitude Above Ground Level (AGL). Out of 212 vehicles, 184 vehicle data were not available for this tracked parameter. The most to the least common maximum cruise altitude AGL are  $1,000 < h \leq 2,000$  ft,  $500 < h \leq 1,000$  ft,  $h \leq 500$  ft,  $2,000 < h \leq 4,000$  ft,  $6,000 < h \leq 7,000$  ft,  $4,000 < h \leq 6,000$  ft. Vehicles operating at or below 2,000 ft make up 65% of the market, while those operating between 2,000 and 7,000 ft take up the other 35%. No vehicles are expected to operate over 7,000 ft AGL. Again, the minimal information available regarding this specific parameter highlights the early stages of the design process for most of these UAM vehicles.

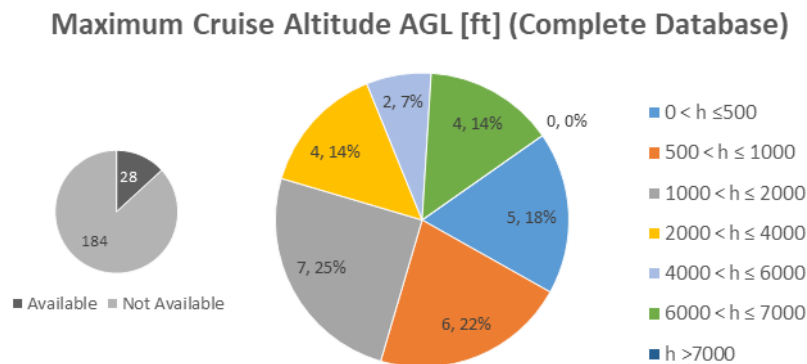

Figure 3.11. Vehicle breakdown by maximum cruise altitude above ground level (AGL) [ft].

### 3.1.1.1.10 Maximum Operating Altitude MSL

Different from the Maximum Cruise Altitude, Maximum Operational Altitude, on the other hand, is specified in terms of MSL. This is because aircraft performance depends on the absolute altitude of an operational area. The maximum mission altitude is limited by the aircraft altitude above sea level and is, therefore, not defined in terms of AGL.

Figure 3.12 shows the breakdown of UAM vehicles by maximum operating altitude Mean Sea Level (MSL). Of 212 vehicles, 175 vehicle data were unavailable for this tracked parameter. The most to the least common maximum operating altitudes MSL are  $10,000 < h \leq 20,000$  ft,  $0 < h \leq 10,000$  ft, and  $20,000 < h \leq 40,000$  ft. Vehicles operating between 10,000 and 20,000 ft altitude dominate the market with 62%, while those operating below 10,000 ft and above 20,000 ft take 30% and 8%, respectively.

Maximum Operating Altitude MSL [ft] (Complete Database)

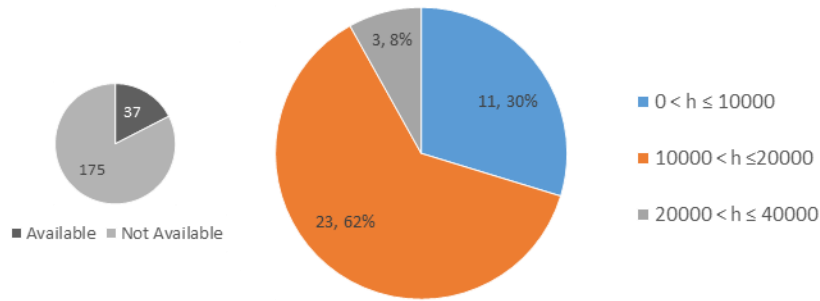

Figure 3.12. Vehicle breakdown by maximum operating altitude mean sea level (MSL) [ft].

3.1.1.1.11 Cruise Speed

Figure 3.13 shows the breakdown of UAM vehicles by cruise speed. Out of 212 vehicles, 81 vehicle data were not available for this tracked parameter. The database's most common cruise speed range for vehicles is between 120 and 180 mph, with 30% of the market share. The least common vehicles are those operating above 350 mph, with a 2% market share. Cruise speed ranges under 120 mph together makeup 46%, and the rest of the ranges between 180 and 350 mph take the remaining 22%.

Cruise Speed [mph] (Complete Database)

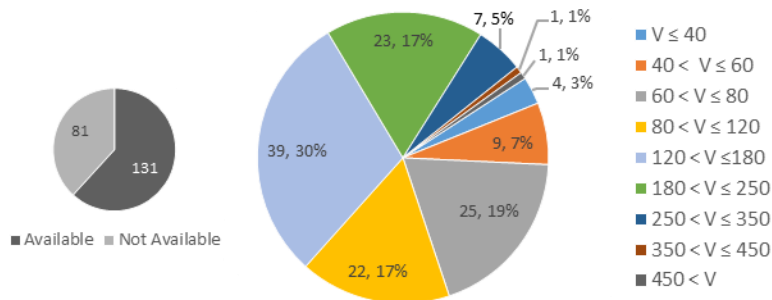

Figure 3.13. Vehicle breakdown by cruise speed [mph].

3.1.1.1.12 Endurance

Figure 3.14 shows the breakdown of UAM vehicles by endurance. Out of 212 vehicles, 81 vehicle data were not available for this tracked parameter. The most common ranges for vehicle endurance are 0.25 < E ≤ 0.5 hr, 0.5 < E ≤ 0.75 hr, 0.75 < E ≤ 1 hr, and 2 < E ≤ 4 hr. These ranges contain 72% of the market, followed closely by 1 < E ≤ 2 hr endurance with 16%. In sum, the vehicles with endurance under 4 hours make up 93%, and those with endurance above 4 hours make up the remaining 7%.

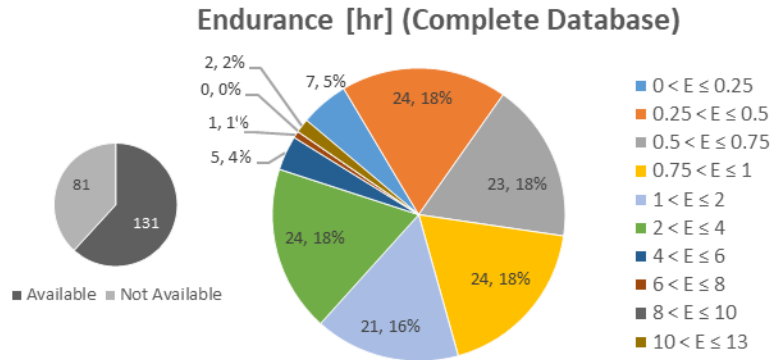

Figure 3.14. Vehicle breakdown by Endurance [hr].

### 3.1.1.1.13 Airframe Material

Figure 3.15 shows the breakdown of UAM vehicles by airframe material. Out of 212 vehicles, 127 vehicle data were not available for this tracked parameter. The composite airframe vehicles overwhelmingly dominate the market with 87% while the composite + metallic and metallic vehicles take 9% and 4%, respectively. Even though this information is limited to only about 40% of the vehicles studied, it highlights the predisposition for using advanced materials.

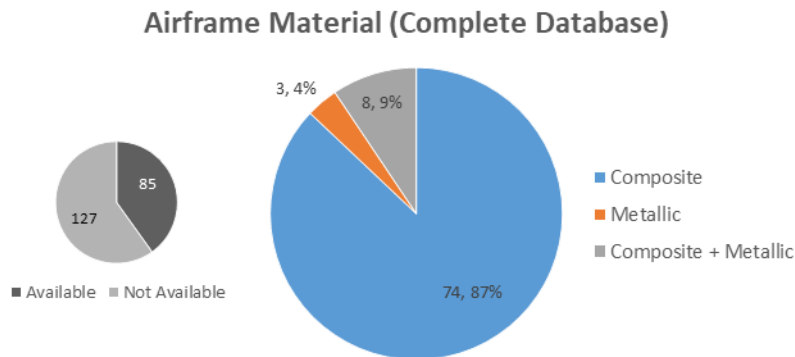

Figure 3.15. Vehicle breakdown by airframe material.

### 3.1.1.1.14 Number of Lifting Propellers

Figure 3.16 shows the breakdown of UAM vehicles by the number of lifting propellers. Of 212 vehicles, 3 vehicle data were unavailable for this tracked parameter. The vehicles with 8 lifting propellers are the most common with 34% of the market, followed by 4 propellers vehicles with 17% and 6 propellers vehicles with 9%. The remainder of the database is varied, with propeller count ranging up to 52 lifting propellers. Each of these propeller counts makes up about 5% or less of the market.

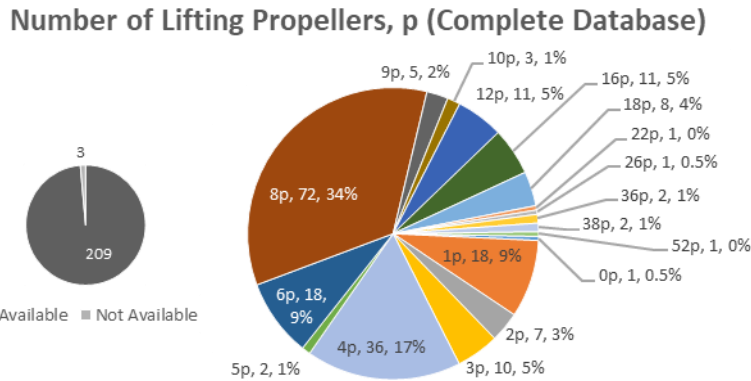

Figure 3.16. Vehicle breakdown by the number of lifting propellers, *p*.

*3.1.1.1.15 Number of Forward Propellers*

Figure 3.17 shows the breakdown of UAM vehicles by the number of forward propellers. Out of 212 vehicles, 31 vehicle data were not available for this tracked parameter. The analyzed trend shows that the lower the number of forward propellers, the more common the UAM vehicles. The vehicles with no forward propellers make up 66% of the market, followed by 1 propeller vehicles with 24% and 2 propeller vehicles with 5%. For the rest of the vehicles with 3 to 10 propellers, each vehicle type takes less than 1% of the market. Typically, vectored thrust vehicles were classified as not having forward propellers.

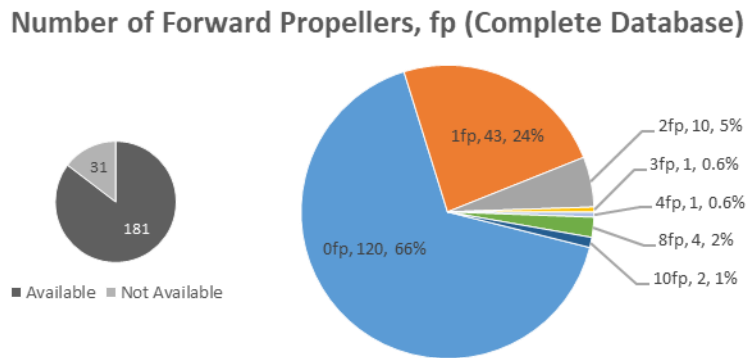

Figure 3.17. Vehicle breakdown by the number of forward propellers, *fp*.

*3.1.1.1.16 Number of Coaxial Propeller Sets*

Figure 3.18 shows the breakdown of UAM vehicles by the number of Coaxial Propeller (*cp*) sets. Of 212 vehicles, 5 vehicle data were unavailable for this tracked parameter. The vehicles with no coaxial propeller sets dominate 71% of the market, followed by 4cp vehicles with 20% and 8cp vehicles with 4%. For the rest of the vehicles with coaxial propeller sets from 1 to 6, each vehicle type makes up 2% or less of the market.

**Number of Coaxial Propeller Sets, cp (Complete Database)**

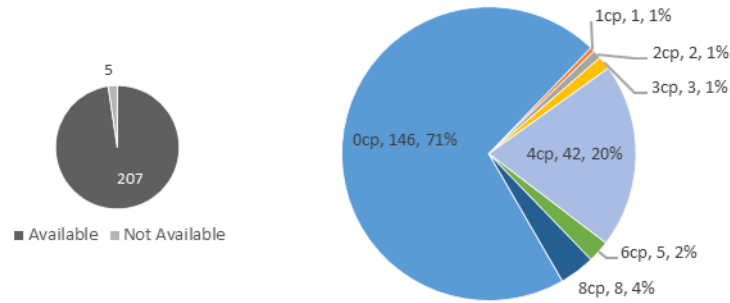

Figure 3.18. Vehicle breakdown by the number of coaxial propeller sets, cp.

*3.1.1.1.17 Target Operation Year*

Figure 3.19 shows the UAM vehicle operation readiness by the target year. Out of 212 vehicles, 167 vehicle data were not available for this tracked parameter. Manufacturers are targeting that 38% of the 45 vehicles with available projections will be fully operational by 2023. All 45 vehicles are expected to be in full service by 2030.

**Target Operation Year (Complete Database)**

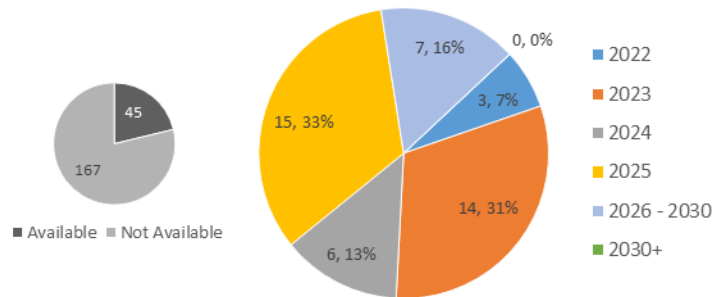

Figure 3.19. Vehicle operation readiness by the target year.

*3.1.1.1.18 Type of Landing Gear*

Figure 3.20 shows the breakdown of UAM vehicles by the type of landing gear. Out of 212 vehicles, 16 vehicle data were not available for this tracked parameter. The most common types of landing gear are skids/legs, followed by retractable tricycle gear and fixed tricycle gear. Vehicles with skids/legs landing gears account for 52% of the market, while retractable and fixed tricycle represent 24% and 20%, respectively. The vehicles with the remaining types of landing gear make up the other 4% of the market.

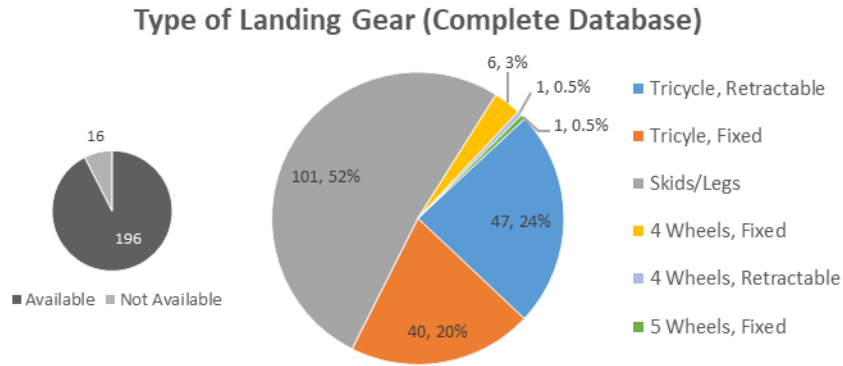

Figure 3.20. Vehicle breakdown by type of landing gear.

#### 3.1.1.1.19 Number of Passengers

Figure 3.21 shows the breakdown of UAM vehicles by the number of passengers (for clarification, the pilot is not counted as a passenger). Out of 212 vehicles, 12 vehicle data were not available for this tracked parameter. Vehicles that carry one passenger are the most common, with 24% of the market, followed closely by zero-passenger vehicles with 22%, four-passenger vehicles with 20%, and two-passenger vehicles with 18%. Although the data is somewhat scattered, a subtle trend suggests that the more passengers the vehicles can carry, the less common it is. Each vehicle type makes up 3% or less of the market for vehicles carrying at least four or more passengers.

From the 0 PAX category, 9% of these 45 vehicles do not provide enough information, 24% represent PAV mission vehicles that will be piloted by the user (not autonomous or remotely piloted), and 67% are related to cargo missions. Within the cargo mission vehicles, 90% claim to be either autonomous or remotely piloted, and only 7% are piloted; the remaining 3% do not provide enough information.

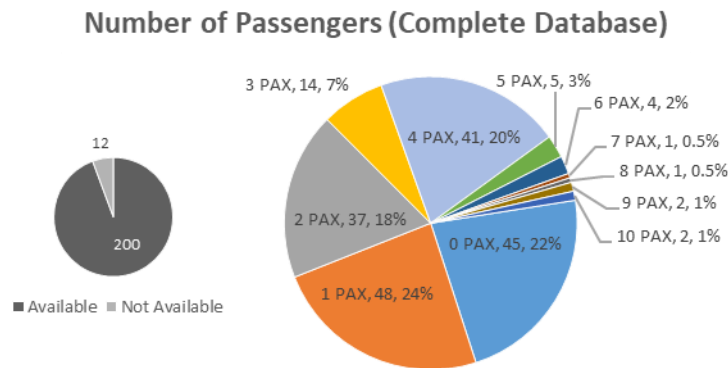

Figure 3.21. Vehicle breakdown by the number of passengers.

### 3.1.1.1.20 Type of Battery

Figure 3.22 shows the breakdown of UAM vehicle popularity by the type of battery (only for electric vehicles). Out of 120 electric vehicles, data for 75 vehicles were not available for this tracked parameter. The most common type of battery is Li-ion, followed by Li-Po and other non-specified Lithium-based. Li-ion vehicles make up 53% of the market, while Li-Po and Lithium-based batteries make 25% and 22%, respectively.

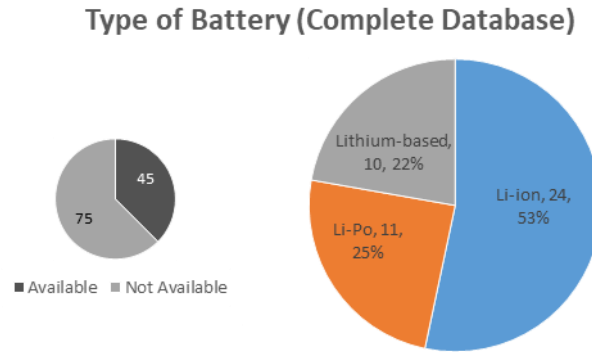

Figure 3.22. Electric vehicle breakdown by type of battery.

### 3.1.1.2 UAM Aircraft Main Characteristics Comparative Analysis for the Complete Database

The following sections present comparisons between vehicle range and various parameters such as payload, cruise speeds, endurance, and the number of passengers for 212 vehicles in the complete database. However, it is noteworthy that some of these vehicles do not have the available data for all the parameters; thus, the comparisons only include the vehicles with the details for the studied parameters.

#### 3.1.1.2.1 Range vs. Payload

Figure 3.23 shows the variation of total payload with respect to the range for different architecture vehicles. Most wingless multicopter vehicles have a short range of about 200 miles and a payload capacity of fewer than 1,000 lb, which are among the lowest values compared to other architectures. On the other hand, the lift + cruise vehicles have ranges of close to 1,600 miles and payloads of up to 6,000 lb. While electric rotorcraft seem to have a viable range and payload for short and light-haul missions, lift + cruise vehicles are the most practical for longer-range and heavier missions. Between the extremes of the spectrum, the vectored thrust vehicles with a range of more than 1,200 miles and payload up to 5,500 lb are most suitable for moderate range and payload operations.

To better illustrate the key takeaways from Figure 3.23, Table 3.1 shows the range and payload information of several UAM vehicles with different architectures from the database. Ehang 216 and Volocopter Volocity, two wingless multicopter vehicles, have the shortest range of 22 miles and a payload of only 485 lb, whereas Pegasus Vertical BJ, a lift + cruise vehicle, has the longest range of 1,320 miles and payload of 5,860 lb. The other vehicles with the vectored thrust configuration have a range between 60 to 190 miles and a payload capacity up to 992 lb.

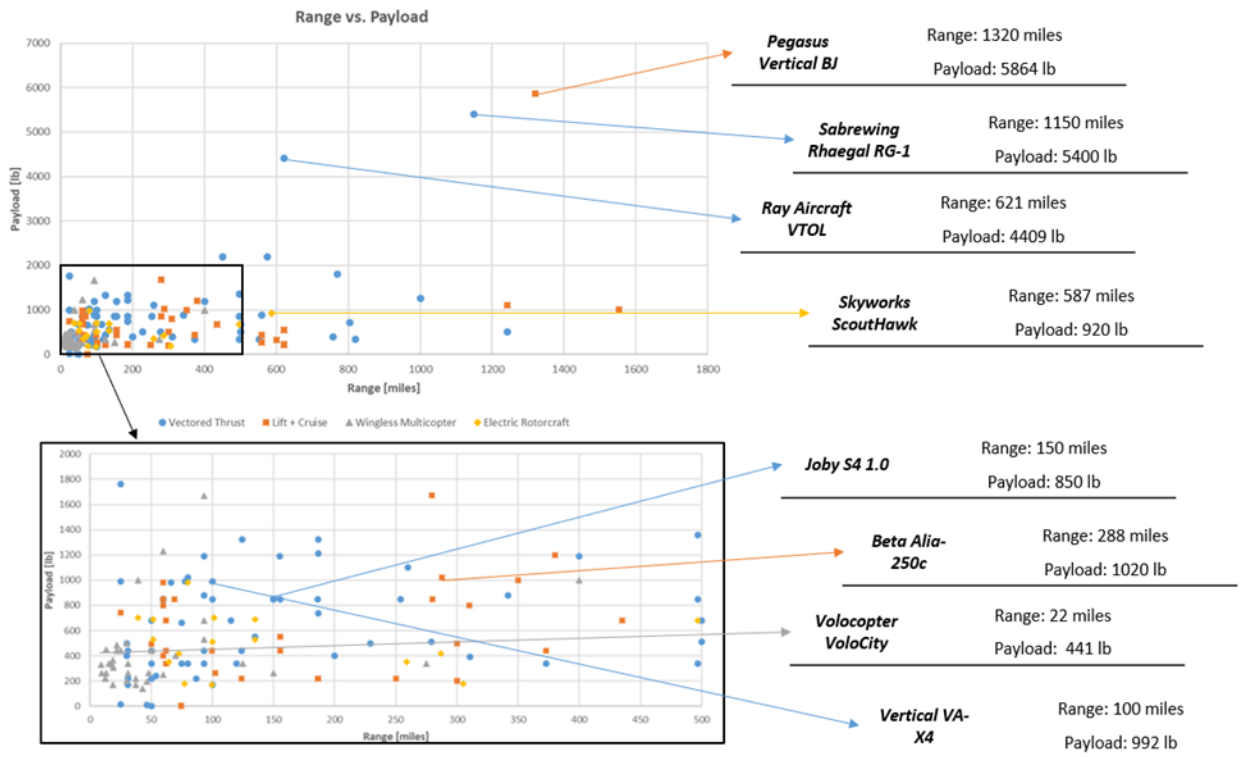

Figure 3.23. Range [miles] vs. Estimated total payload [lb.].

Table 3.1. Range and payload information of several UAM vehicles.

Vehicle	Vehicle Architecture	Range [miles]	Estimated Total Payload [lb]
Ehang 216	Wingless Multicopter	22	485
Beta Alia-250c	Lift + Cruise	288	1020
Lilium Jet 4PAX	Vectored Thrust	190	850
Archer Marker 2 PAX	Vectored Thrust	60	850
Pegasus Vertical BJ	Lift + Cruise	1,320	5,860
Joby S4 1.0	Vectored Thrust	150	850
Volocopter VoloCity	Wingless Multicopter	22	441
Vertical VA-X4	Vectored Thrust	100	992
Hyundai S-A1	Vectored Thrust	60	850
Pipistrel Nuuva V300	Lift + Cruise	1550	1014

### 3.1.1.2.2 Range vs. Number of Passengers

Figure 3.24 shows the number of passengers for each vehicle and the expected range for different vehicle architectures. Most wingless multicopter vehicles have a short range of about 200 miles and a transport capacity of two passengers, which are among the lowest values compared to other architectures. Lift + cruise vehicles, on the other hand, have ranges up to 1,600 miles and a transport capacity of up to six passengers. While electric rotorcraft seem to have a viable range and transport capacity for short and light-haul missions, lift + cruise vehicles are the most practical for longer-range and heavier missions. In between the extremes of the spectrum, the vectored thrust



vehicles with a maximum range of about 1,200 miles and transport capacity of up to nine people are most suitable for moderate range and a large number of passenger transport operations.

To better illustrate the key takeaways from Figure 3.24, Table 3.2 shows the range and number of passengers of several UAM vehicles with different architectures from the database. Ehang 216, a wingless multicopter vehicle, has the shortest range of 22 miles and a transport capacity of only two passengers, whereas Beta Alia-250c, a lift + cruise vehicle, has the longest range of 290 miles and a transport capacity of 5 passengers. The other vehicles with the vectored thrust configuration have a range between 150 to 190 miles and a transport capacity of four passengers.

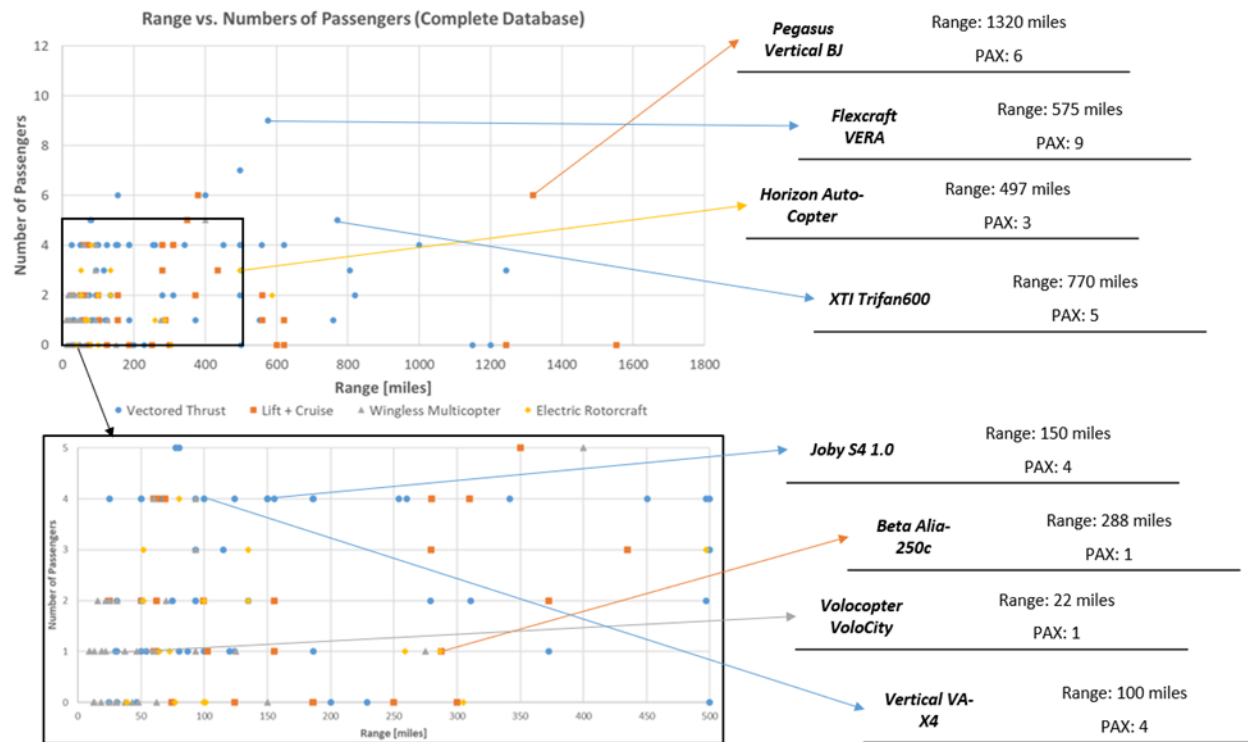

Figure 3.24. Range [miles] vs. Number of Passengers.

Table 3.2. Range and number of passengers of several UAM vehicles.

Vehicle	Vehicle Architecture	Range [miles]	Number of Passengers
<b>Ehang 216</b>	Wingless Multicopter	22	2
<b>Beta Alia-250c</b>	Lift + Cruise	290	5
<b>Lilium Jet 4PAX</b>	Vectored Thrust	190	4
<b>Wisk Cora</b>	Lift + Cruise	25	2
<b>Joby S4 1.0</b>	Vectored Thrust	150	4
<b>Volocopter VoloCity</b>	Wingless Multicopter	22	1
<b>Vertical VA-X4</b>	Vectored Thrust	100	4
<b>Hyundai S-A1</b>	Vectored Thrust	60	4
<b>Pipistrel Nuuva V300</b>	Lift + Cruise	1550	0
<b>Volocopter Voloconnect</b>	Lift + Cruise	62	4

### 3.1.1.2.3 Range vs. Cruise Speed:

Figure 3.25 presents the cruise speed and range for different architecture vehicles. Most wingless multicopter vehicles have a short range of fewer than 200 miles and a cruise speed of about 100 mph, which are among the lowest values compared to other architectures. Lift + cruise vehicles, on the other hand, have ranges of up to 1,600 miles and cruise speeds up to nearly 500 mph. While electric rotorcraft seem to have a viable range and transport capacity for short and light-haul missions, lift + cruise vehicles are the most practical for longer-range and faster missions. In between the spectrum extremes, vectored thrust vehicles have a wide variety of estimated ranges. Some of these vehicles have estimated ranges of nearly 400 miles cruise speeds comparable to lift + cruise architectures. These vehicles are most suitable for moderate range and cruise speed operations.

To better illustrate the key takeaways from Figure 3.25, Table 3.3 shows the range and cruise speed of several UAM vehicles with different architectures from the database. Ehang 216, a wingless multicopter vehicle, has the shortest range of 22 miles and a cruise speed of only 62 mph, whereas Pipistrel Nuuva300, a lift + cruise vehicle, has the longest range of 1,550 miles and a cruise speed of 100 mph. The other vehicles with the vectored thrust configuration have a range between 50 to 100 miles and cruise speeds between 75 to 175 mph.

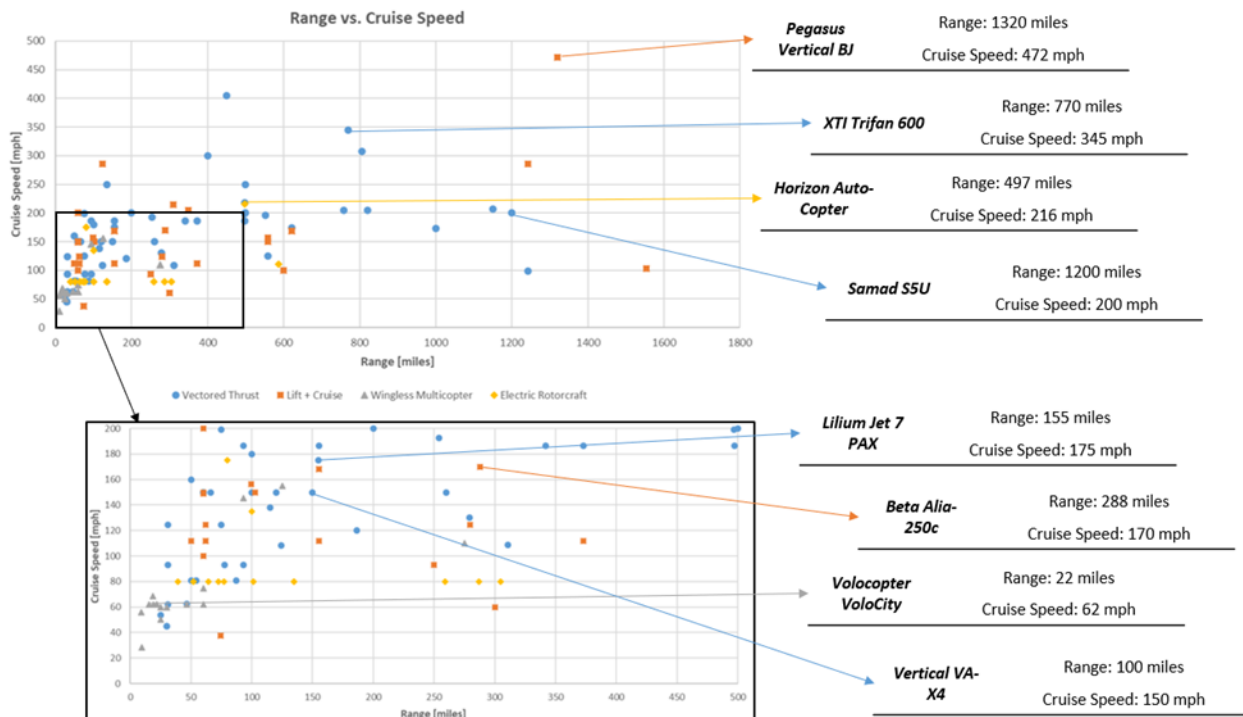

Figure 3.25. Range [miles] vs. Cruise speed [mph].

Table 3.3. Range and cruise speed of several UAM vehicles.

Vehicle	Vehicle Architecture	Range [miles]	Cruise Speed [mph]
<b>Ehang 216</b>	Wingless Multicopter	22	62
<b>Vertical Aerospace VA-X4</b>	Vectored Thrust	100	150
<b>Pipistrel Nuuva V300</b>	Lift + Cruise	1,550	100
<b>Archer Marker 2 PAX</b>	Vectored Thrust	60	150
<b>Lilium Jet 7 PAX</b>	Vectored Thrust	155	175
<b>Beta Alia-250c</b>	Lift + Cruise	288	170
<b>Volocopter Volocity</b>	Wingless Multicopter	22	62
<b>Hyundai S-A1</b>	Vectored Thrust	60	180
<b>CityAirbus NextGen</b>	Vectored Thrust	50	75

#### 3.1.1.2.4 Range vs. Endurance

Figure 3.26 shows the scatter plot of range against endurance for different architecture vehicles. Most wingless multicopter vehicles have a short range of about 200 miles and endurance of about 1 hour, which are among the lowest values compared to other architectures. Lift + cruise vehicles, on the other hand, have ranges of up to 1,600 miles and endurance of up to 12 hours. While electric rotorcraft seem to have a viable range and transport capacity for short and light-haul missions, lift + cruise vehicles are the most practical for longer-range and endurance missions. In between the extremes of the spectrum, the vectored thrust vehicles with a range of about 1,200 miles and endurance of up to 13 hours are most suitable for moderate range and high endurance operations.

To better illustrate the key takeaways from Figure 3.26, Table 3.4 shows the range and endurance of several UAM vehicles with different architectures from the database. Ehang 216 and Volocopter Volodrone, the wingless multicopter vehicles, have the shortest range between 22 to 25 miles and endurance of 0.4 and 0.5 hours, respectively, whereas Pipistrel Nuuva300, a lift + cruise vehicle, has the longest range of 1,550 miles and an endurance of 12 hours based on a cruised velocity of 100 mph and a maximum speed of 137 mph. The other vehicles, Lilium Jet 4PAX and Lilium Jet 7PAX, with the vectored thrust configuration, have a range between 155 and 186 miles and an endurance of 1 hour.

Table 3.4. Range and endurance of several UAM vehicles.

Vehicle	Vehicle Architecture	Range [miles]	Endurance [hr]
<b>Ehang 216</b>	Wingless Multicopter	22	0.4
<b>Lilium Jet 4PAX</b>	Vectored Thrust	186	1
<b>Lilium Jet 7PAX</b>	Vectored Thrust	155	1
<b>Wisk Cora</b>	Lift + Cruise	60	0.5
<b>Pipistrel Nuuva V300</b>	Lift + Cruise	1,550	12
<b>Volocopter Volodrone</b>	Wingless Multicopter	25	0.5

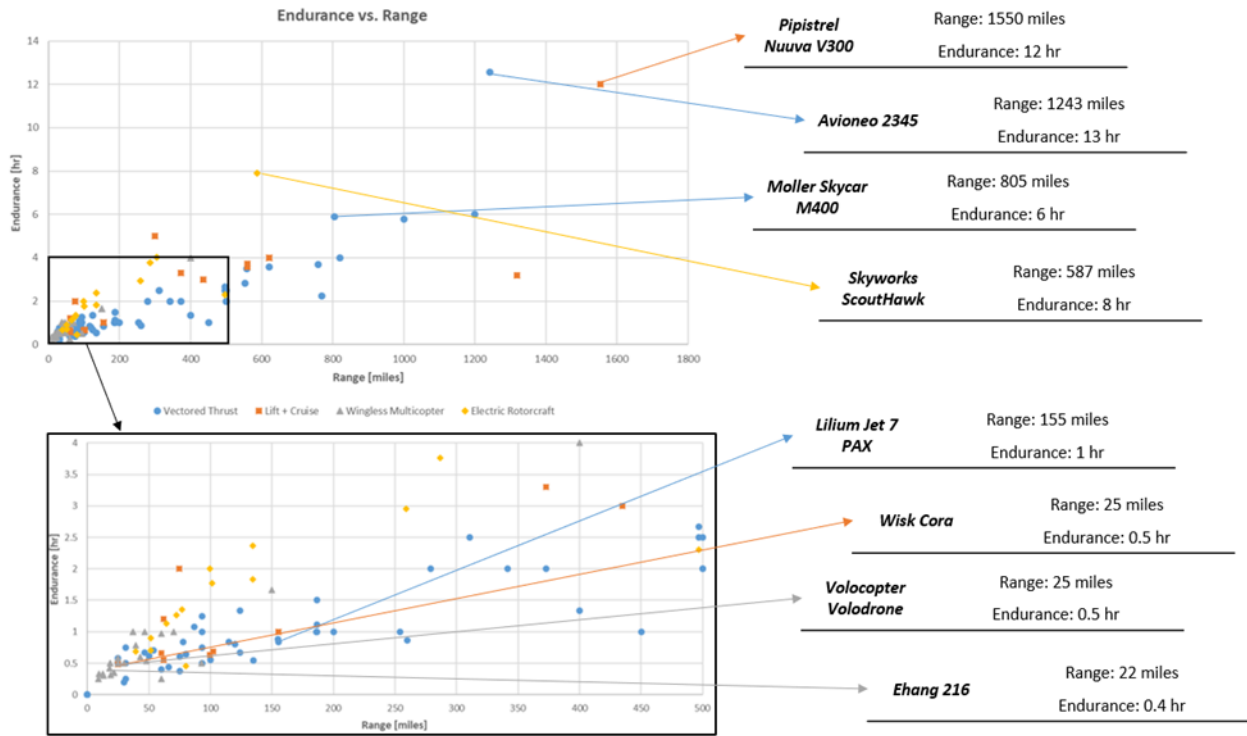

Figure 3.26. Range [miles] vs. Endurance [hr].

### 3.1.1.2.5 Manufacturers per Country:

Figure 3.27 shows the total number of manufacturers per country from the complete database until June 2021. The top countries with the highest number of manufacturers are the USA, Germany, France, Russia, and the UK. The US leads the global market with 54 manufacturers, followed by Germany and France with 14 and 9 manufacturers, respectively. As the UAM market becomes more popular, the number of manufacturers is expected to increase accordingly.

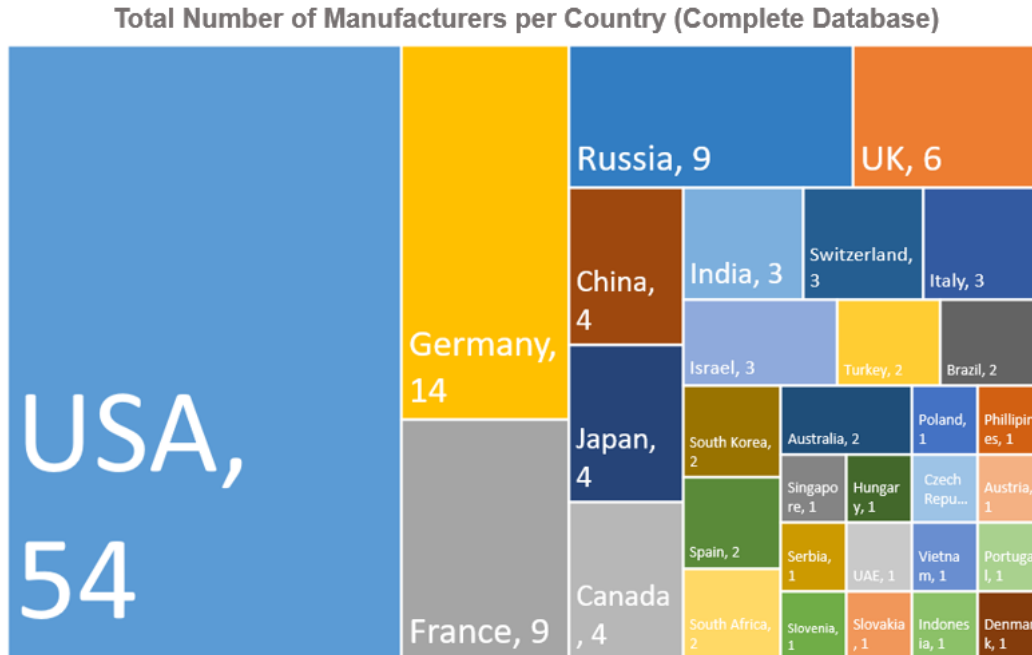

Figure 3.27. Total number of UAM vehicle manufacturers per country.

### 3.1.2 Top 10+ Vehicles Subset

It is reasonable to expect that only a few vehicles from the complete database will successfully take their designs to the operation phase. With this in mind, the entire database was reduced to the vehicles with the highest likelihood of succeeding from the Top 12 OEMs based on the AAM Reality Index (ARI). Table 3.5, updated on February 21, 2022, shows the Top 12 OEMs of the database and a total of 18 vehicles.

The ARI is a rating tool that is described as follows by their developers SMG Consulting: “based on a proprietary formula that uses publicly available information as well as expert knowledge. It helps assess the industry entrants' progress toward the delivery of a certified product at mass-scale production. While at launch, 14 OEMs were rated, the tool is periodically updated to include new entrants as well as any new information on existing entrants. We plan to expand the tool to other areas of the AAM ecosystem. The tool is unbiased and data-based. It is not meant as an endorsement or a critique of any specific company, but as a simple, easy-to-use guide to the complexities of the AAM industry” (SMG Consulting LLC, 2022).

The ARI is based on five elements:

1. The funding received by the company
2. The leading team
3. The technology readiness
4. The certification progress
5. The production readiness toward full-scale manufacturing

Table 3.5. Top 12 OEMs and their 18 VTOL vehicles studied. Data from (SMG Consulting LLC, 2022).

Rank	OEM	ARI	Funding [\$M]	Vehicles	Country
1	Joby Aviation	8.4	\$1,844.6	S4	USA
2	Beta Technologies	7.8	\$511.0	Alia S250c	USA
3	Lilium	7.8	\$938.0	Jet 4 PAX Jet 7 PAX	Germany
4	Wisk	7.5	Corporate backed	Cora	USA
5	Ehang	7.4	\$132.0	EH 216 EH 216L EH 116	China
6	Volocopter	7.3	\$376.6	VoloCity Volcanic VoloDrone	Germany
7	Pipistrel	7.2	Corporate backed	Nuuva V300	Slovenia
8	Archer	7.2	\$856.3	Maker 2 PAX Maker 5 PAX	USA
9	Airbus	7.0	Corporate backed	CityAirbus NextGen	France
10	Hyundai	6.7	Corporate backed	S-A1	South Korea
11	Astro Aerospace	N/A	N/A	Elroy	USA
12	Vertical Aerospace	N/A	\$294.0	VA-X4	UK

### 3.1.2.1 Top 10+ Subset Database Breakdown

This section presents similar analyses done in Section 3.1.1 but with a focus on the top 18 vehicles subset database rather than the complete database with 212 vehicles. This more focused analysis aims to provide a deeper insight into the market conditions since these top vehicles have the best chances to succeed in the operation phase.

### 3.1.2.1.1 Vehicle Architecture

Figure 3.28 shows the breakdown of top UAM vehicles by architecture. Data were available for all 18 vehicles. Vehicle architectures, in order of most to least common, are vectored thrust, wingless multicopter, and lift + cruise. The vectored thrust dominates 45% of the market, followed by the wingless multicopter share of 33%, and lift + cruise share of 22%. No electric rotorcraft are in this subset. Electric rotorcraft is the closest configuration to conventional rotorcraft and, therefore, is the configuration where the industry has more knowledge and experience; however, none of the companies included in the Top 10+ database subset chose this configuration.

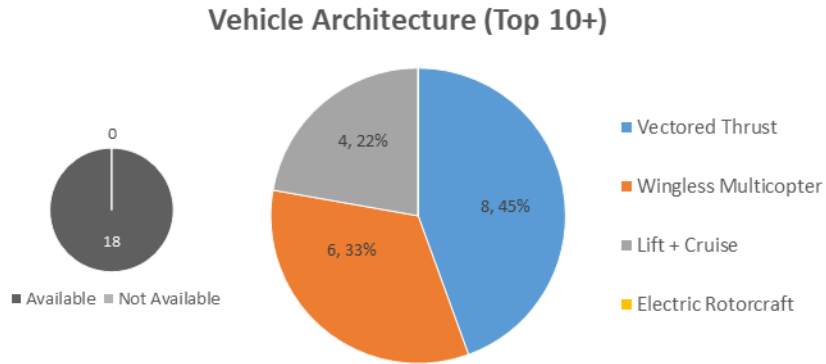

Figure 3.28. Top vehicles – Architecture.

### 3.1.2.1.2 Type of Propulsion System

Figure 3.29 shows the breakdown of top UAM vehicles by type of propulsion system. Data were available for all 18 vehicles. Ninety-four percent of the designs utilize electric propulsion, while a single design uses a hybrid system.

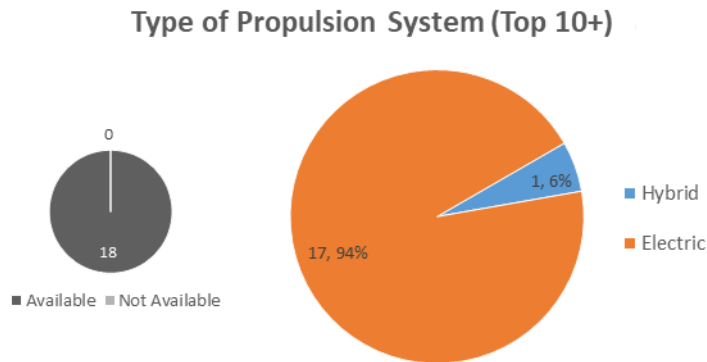

Figure 3.29. Top vehicles – Type of propulsion system.

### 3.1.2.1.3 Maturity Level

Six vehicles from the Top 10+ database have claimed they are working with authorities to certify their aircraft for flight. Table 3.6 summarizes those vehicles along with the agencies and the Parts under which they are planning to be certified. Figure 3.30 illustrates the maturity level for the top

10+ vehicles set studied. Out of 18 top vehicles, 4 vehicle data were not available for this tracked parameter. The most common maturity level is ongoing certification, followed by prototype build, subscale flight test, and full-scale flight test. The ongoing certification vehicles comprise 43% of the market, nearly doubling the prototype build vehicles of 22% and subscale flight test vehicles of 21%. The remaining 2% belongs to full-scale flight test vehicles.

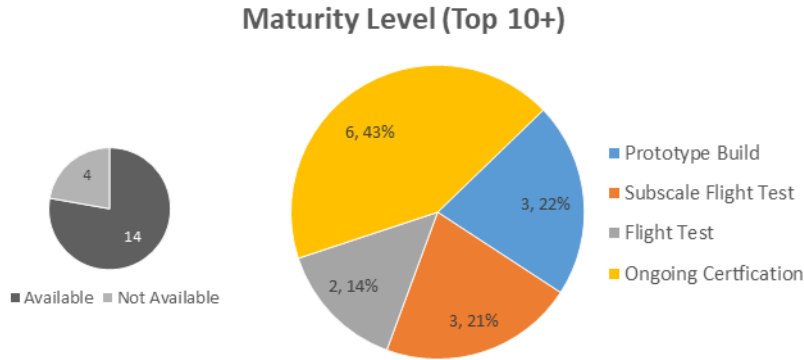

Figure 3.30. Top vehicles – Maturity level.

Table 3.6. Top vehicles and their Type Certificate approach.

OEM	Vehicle	Agency	Part
<b>Joby</b>	<i>S4 1.0</i>	FAA	Part 23
<b>Lilium</b>	<i>Jet 4 PAX</i>	EASA	SC-VTOL
<b>Ehang</b>	<i>216</i>	CAAC	N/A
<b>Wisk</b>	<i>Cora</i>	FAA	N/A
<b>Volocopter</b>	<i>VoloCity</i>	EASA	SC-VTOL
<b>Astro Aerospace</b>	<i>Elroy</i>	FAA	N/A

#### 3.1.2.1.4 Certification Plans

Figure 3.31 shows the breakdown of top UAM vehicles by the certification agency. Out of 18 vehicles, data were not available for four vehicles. The most to least common certification agencies are EASA, FAA, and CAAC. With a difference of 7% between each other, FAA and EASA together comprise 79% of the market.

Figure 3.32 provides more insight into the top vehicles with ongoing certification under FAA (a) and EASA (b) guidelines. Only one of the five vehicles with ongoing FAA certification had available data. The Joby S4 1.0 vehicle is ongoing certification under Part 23. All six vehicle data with the ongoing EASA certification were available for this tracked parameter. Under the EASA guidelines, the common types of certification are SC-VTOL and CS-UAS. SC-VTOL has the highest market share of overwhelmingly 83%, while CS-UAS takes the remaining share of 17%.



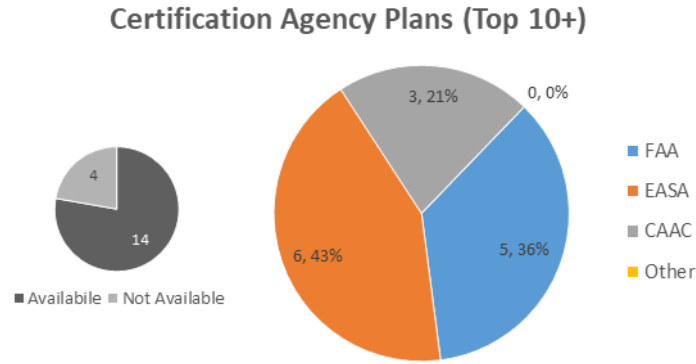

Figure 3.31. Top vehicles – Certification agency.

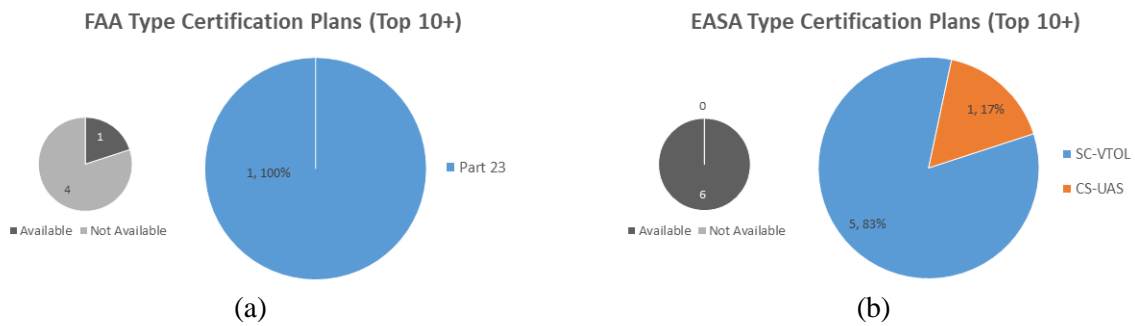

Figure 3.32. Top vehicles – (a) FAA certification and (b) EASA certification.

#### 3.1.2.1.5 MTOW

Figure 3.33 shows the breakdown of top UAM vehicles by MTOW. Out of 18 vehicles, data were not available for five of the vehicles. The most common MTOW range for a vehicle is under 2,000 lb, followed by ranges between 6,000 lb and 10,000 lb and 2,000 to 4,000 lb. The trend analyzed from this data suggests that the lower the MTOW, the more popular the UAM vehicles. The MTOW vehicles with less than 6,000 lbs make up 69% of the market. The remaining 31% belongs to vehicles with MTOW between 6,000 and 10,000 lbs. No vehicles in this subset have MTOW exceeding 10,000 lb.

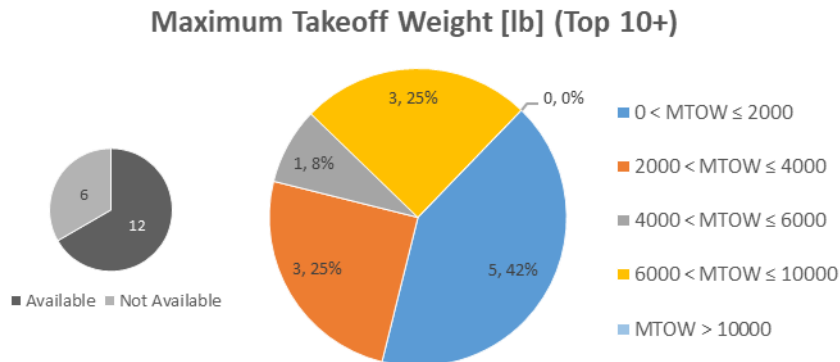

Figure 3.33. Top vehicles – Maximum takeoff weight (MTOW) [lb].

### 3.1.2.1.6 Mission Purpose

Figure 3.34 shows the breakdown of top UAM vehicles by the primary (a) and secondary (b) missions. Data were available for the primary mission of all 18 vehicles. Secondary mission data was not available for 12 of the 18 vehicles. Air taxi is the most common primary mission, followed by cargo, regional, and PAV. On the other hand, the most to least common secondary missions are cargo, PAV, and air taxi. Most vehicles are being designed and constructed to operate as air taxis, but as with those in the complete database, some vehicles have a secondary mission. Some manufacturers approach these multi-purpose missions by modifying the vehicle as required. Some modifications include removing or adding the passenger seats to switch between air taxi to cargo and vice-versa, like BETA ALIA-250c.

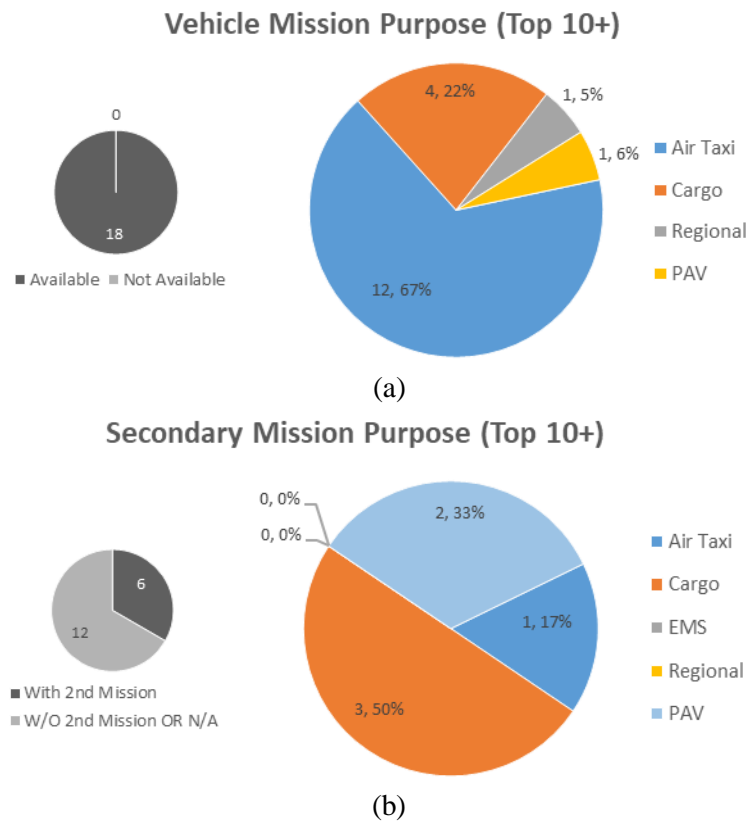

Figure 3.34. Top Vehicles – Mission Purpose (a) primary and (b) secondary.

### 3.1.2.1.7 Autonomy Level

Figure 3.35 shows the breakdown of top UAM vehicles by the autonomy level. Data were available for all 18 vehicles. The piloted vehicles comprise 61% of the market, while autonomous and piloted remotely vehicles make 28% and 11% of the market shares, respectively. Even though the certification progress and the technology readiness play a role in the ARI score, a few vehicles in the Top 10+ subset are designed to operate autonomously. Table 3.7 presents the autonomous vehicles found in this subset.

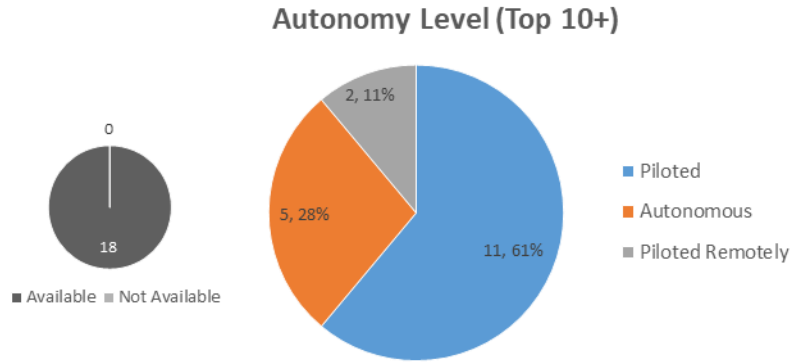

Figure 3.35. Top vehicles – Autonomy level.

Table 3.7. Top 10+ Subset Autonomous Vehicles

OEM	Vehicle	Vehicle Type	Maturity	PAX	Target Operation Year
<b>Wisk</b>	<i>Cora</i>	Lift+Cruise	Ongoing Certification	2	2024
<b>Ehang</b>	<i>216</i>	Wingless Multicopter	Ongoing Certification	2	2025
<b>Ehang</b>	<i>116</i>	Wingless Multicopter	N/A	1	N/A
<b>Pipistrel</b>	<i>Nuova V300</i>	Lift+Cruise	N/A	0	2023
<b>Astro Aerospace</b>	<i>Elroy</i>	Wingless Multicopter	Ongoing Certification	1	N/A

3.1.2.1.8 *Estimated Total Payload*

Figure 3.36 shows the breakdown of top UAM vehicles by the estimated total payload. Data were available for all 18 vehicles. Vehicles with payloads between 500 and 1,000 lb compose 50% of the market, followed by vehicles with payloads less than 500 lb, which make up another 33%. Vehicles with payloads higher than 1000 lb see a market share of about 17%.

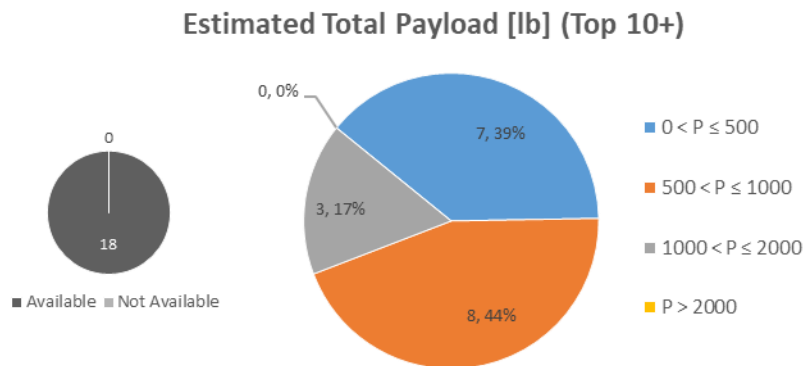

Figure 3.36. Top vehicles – Estimated total payload [lbs].

3.1.2.1.9 *Maximum Cruise Altitude AGL*

Figure 3.37 shows the breakdown of top UAM vehicles by maximum cruise altitude (AGL). Out of 18 vehicles, data were not available for 15. Two vehicles are intended to operate between 1,000 and 2,000 ft AGL, while the other with available data is slated to operate between 4,000 and 6,000 ft. This parameter again highlights that even for the most “developed” vehicles, some operational characteristics are still unavailable or not yet defined.

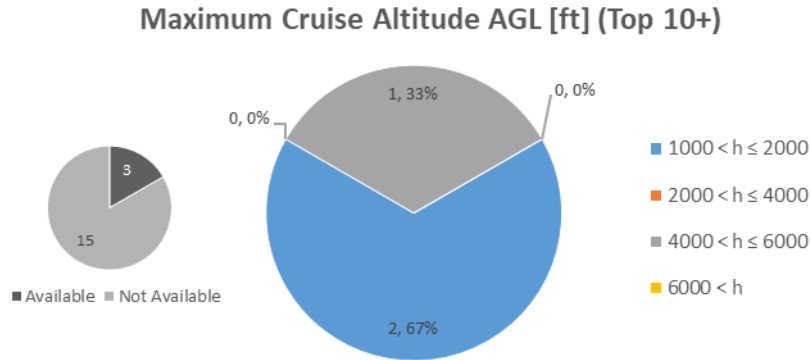

Figure 3.37. Top vehicles – Maximum cruise altitude above ground level (AGL) [ft].

3.1.2.1.10 *Maximum Operating Altitude MSL*

Figure 3.38 shows the breakdown of top UAM vehicles by maximum operating altitude MSL. As for the previous parameter, very limited information is available. Out of 18 vehicles, data were not available for 13 of them. Of the vehicles with available data, four intend to operate below 10,000 ft above MSL, and the remaining vehicle below 20,000 ft. No vehicles are intended to operate above 20,000 ft.

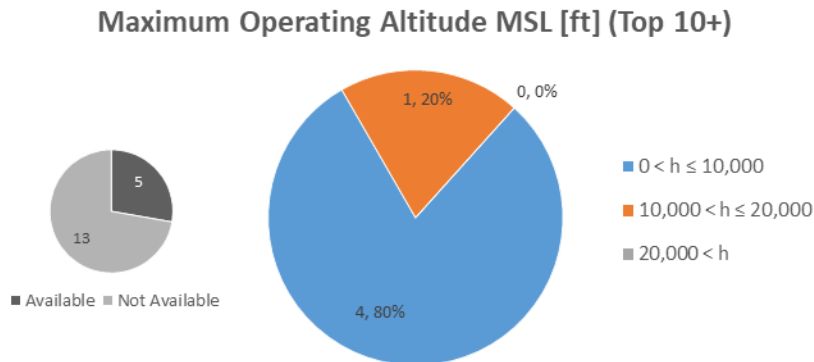

Figure 3.38. Top vehicles – Maximum operating altitude mean sea level (MSL) [ft].

3.1.2.1.11 *Cruise Speed*

Figure 3.39 shows the breakdown of top UAM vehicles by cruise speed. Out of 18 vehicles, data were not available for four (4) vehicles. The most common cruise speeds are between 120 and 180

mph, with 43% of vehicles with available data, and between 60 and 80 mph with 36%. No vehicles are expected to operate above 180 mph. The other cruise speeds make up the remaining 21%.

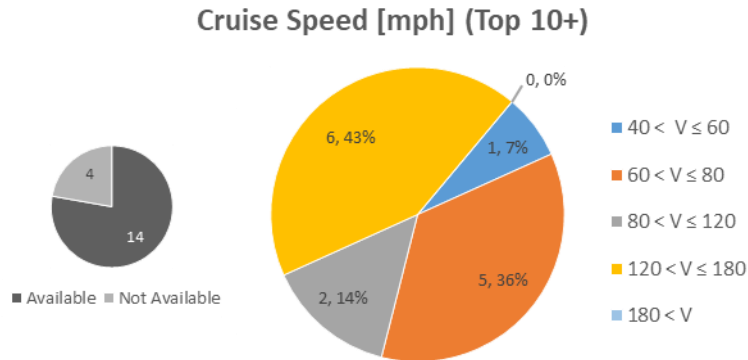
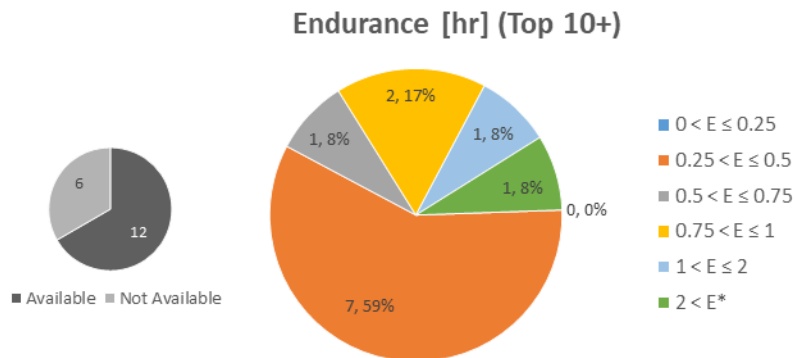

Figure 3.39. Top vehicles – Cruise speed [mph].

### 3.1.2.1.12 Endurance

Figure 3.40 shows the breakdown of top UAM vehicles by endurance. Out of 18 vehicles, data were not available for six vehicles. Seven vehicles (64% of this subset) expect to have an endurance between 0.25 and 0.5 hr. Vehicles with endurance between 0.75 and 1 hour make up another 18%. No vehicles in this subset expect to have an endurance of less than a quarter-hour.

Note that only one vehicle has an endurance greater than 2 hours, the Pipistrel Nuuva 300. This aircraft is a lift + cruise vehicle with an endurance of 12 hours that will be used for cargo operations.



\*Vehicle with E > 2 hr – Pipistrel Nuuva 300; E = 12hr

Figure 3.40. Top vehicles – Endurance [hr].

3.1.2.1.13 Airframe Material

Figure 3.41 shows the breakdown of top UAM vehicles by airframe material. Out of 18 vehicles, data were not available for eight vehicles. Seven of the vehicles in this subset plan to use composite airframes, while the remaining three anticipate using a composite + metallic airframe. No companies in this subset anticipate relying on a completely metallic airframe.

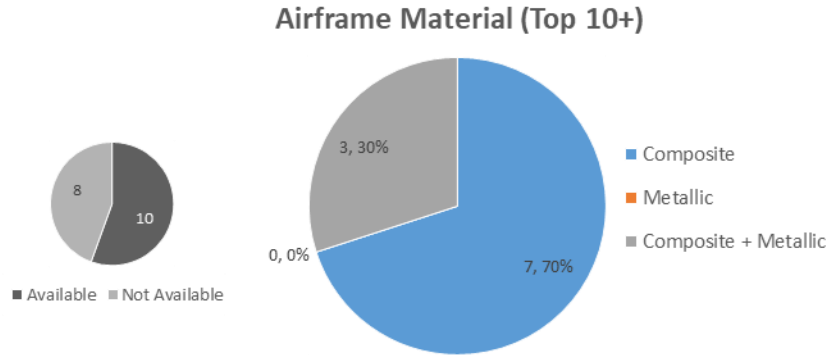

Figure 3.41. Top vehicles – Airframe Material.

3.1.2.1.14 Number of Lifting Propellers

Figure 3.42 shows the breakdown of top UAM vehicles by the number of lifting propellers. Data were available for all 18 vehicles. The most common are vehicles with 8, 12, and 16 lifting propellers. Each configuration represents 22% of this subset, followed by 18 and 36 propellers vehicles with 11%.

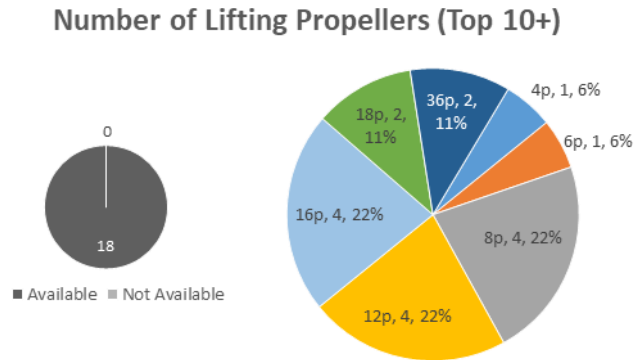

Figure 3.42. Top vehicles – Number of lifting propellers, p.

3.1.2.1.15 Number of Forward Propellers

Figure 3.43 shows the breakdown of the top UAM vehicles by the number of forward propellers. Out of 18 vehicles, data were not available for eleven (11) vehicles. Vehicles with single and no forward propellers are the most common. Each represents 43% of the market, followed by 2 propellers vehicles with the remaining 14%. Designs with 3 to 10 propellers are not present in this Top 10+ subset.

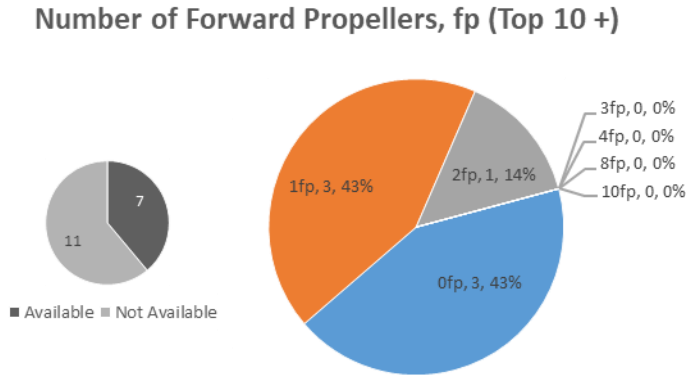

Figure 3.43. Top vehicles – Number of forward propellers.

*3.1.2.1.16 Number of Coaxial Propeller Sets*

Figure 3.44 shows the breakdown of top UAM vehicles by the number of coaxial propeller sets. Out of 18 vehicles, data were available for all but one vehicle. Most vehicle designs (twelve) do not plan to utilize coaxial propellers, while four plan to utilize eight coaxial propellers.

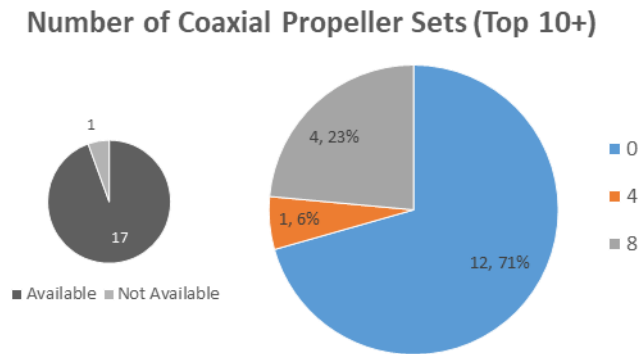

Figure 3.44. Top vehicles – Number of coaxial propeller sets.

*3.1.2.1.17 Target Operation Year*

Figure 3.45 shows the top UAM vehicle operation readiness by the target year. Out of 18 vehicles, data were not available for six vehicles in this subset. Most of the vehicles included in the subset, about 83%, plan to start operations in or before 2025. The remaining portion of vehicles is planning on operating before the end of the decade. Considering that only 6 vehicles are currently ongoing certification, this date may have to be extended. Table 3.8 presents the top 10+ subset vehicles and their target operation year.

Target Operation Year (Top 10+)

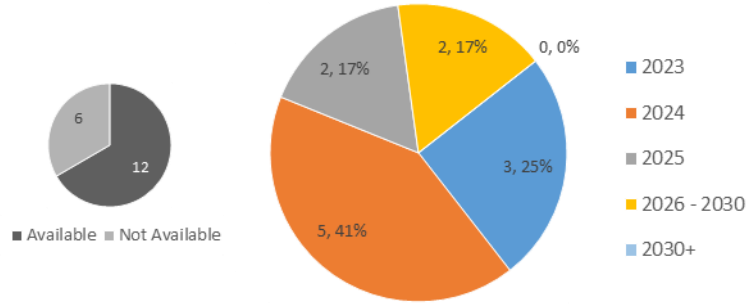

Figure 3.45. Top vehicles – Target operation year.

Table 3.8. Top 10+ Subset Vehicles – Target Operation Year Summary

OEM	Vehicle	Vehicle Type	Maturity	Autonomy Level	Target Operation Year
<b>Joby</b>	S4 1.0	Vectored Thrust	Ongoing Certification	Piloted	2024
<b>Beta Technologies</b>	ALIA-250c	Lift+Cruise	Flight Test	Piloted	2023
<b>Lilium</b>	Jet 4 PAX	Vectored Thrust	Ongoing Certification	Piloted	2025
<b>Lilium</b>	Jet 7PAX	Vectored Thrust	#N/A	Piloted	2024
<b>Wisk</b>	Cora	Lift+Cruise	Ongoing Certification	Autonomous	2024
<b>Ehang</b>	216	Wingless Multicopter	Ongoing Certification	Autonomous	2025
<b>Ehang</b>	216L	Wingless Multicopter	#N/A	Piloted Remotely	#N/A
<b>Ehang</b>	116	Wingless Multicopter	#N/A	Autonomous	#N/A
<b>Volocopter</b>	Volodrone	Wingless Multicopter	Flight Test	Piloted Remotely	#N/A
<b>Volocopter</b>	Voloconnect	Lift+Cruise	Subscale Flight Test	Piloted	2026
<b>Volocopter</b>	VoloCity	Wingless Multicopter	Ongoing Certification	Piloted	2023
<b>Pipistrel</b>	Nuuva V300	Lift+Cruise	#N/A	Autonomous	2023
<b>Archer Aviation</b>	Maker	Vectored Thrust	Subscale Flight Test	Piloted	2024
<b>Archer Aviation</b>	Five Seater	Vectored Thrust	Subscale Flight Test	Piloted	#N/A
<b>Airbus</b>	CityAirbus NextGen	Vectored Thrust	Prototype Build	Piloted	
<b>Hyundai</b>	S-A1	Vectored Thrust	Prototype Build	Piloted	2028
<b>Astro Aerospace</b>	Elroy	Wingless Multicopter	Ongoing Certification	Autonomous	#N/A
<b>Vertical Aerospace</b>	VA-X4	Vectored Thrust	Prototype Build	Piloted	2024



### 3.1.2.1.18 Type of Landing Gear

Figure 3.46 shows the breakdown of top UAM vehicles by the type of landing gear. Data were available for all 18 vehicles in this subset. Half of the vehicle designs include skids/legs. Of the remaining half, retractable tricycle gear is slightly favored. In general, skids or legs designs allow for weight reduction, while a tricycle configuration allows the vehicle to take off and land conventionally if required and provides a benefit in terms of aerodynamic drag. Another consideration is that a fixed landing gear typically results in higher drag and noise, while retractable landing gear systems are generally heavier.

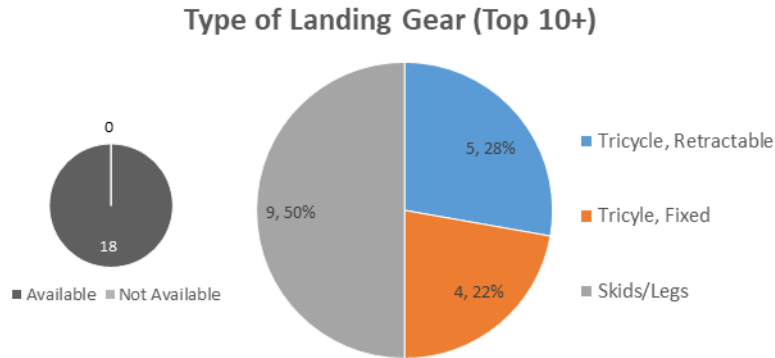

Figure 3.46. Top vehicles – Landing gear type.

### 3.1.2.1.19 Number of Passengers

Figure 3.47 shows the breakdown of top UAM vehicles by the number of passengers (for clarification, the pilot is not counted as a passenger). Data were available for all 18 vehicles of this subset. Vehicles that carry 4 passengers are the most common, with 44% of the subset, followed closely by 1 passenger vehicle with 22%, and 2 passenger vehicles with 17%. One of the vehicles' primary missions is as a cargo aircraft, therefore not carrying any passengers. The two vehicles presented in the 0 PAX category correspond to cargo missions where one vehicle is autonomous, and the other is piloted remotely.

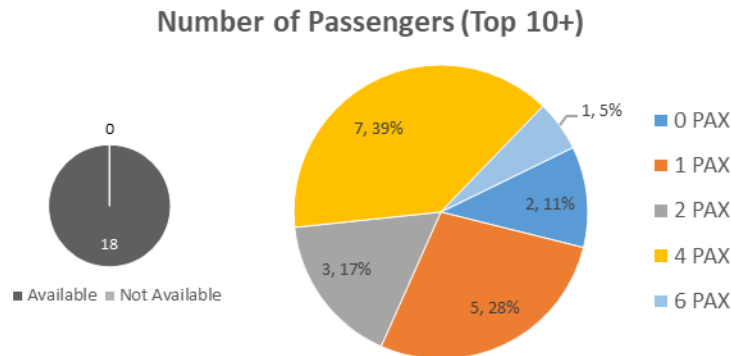

Figure 3.47. Top vehicles – Number of passengers.

### 3.1.2.1.20 Type of Battery

All of the vehicles comprised in the Top 10+ subset, for which the battery type is available (6/18), use Li-ion batteries.

### 3.1.2.1.21 Pipistrel Nuuva 300

Table 3.9 shows the specifications of the Pipistrel Nuuva 300, which has the longest range and endurance among the top 18 vehicles. It also has a cruise speed of 100 mph and a payload capacity of 3,750 lb. Since it is designed for the cargo transport category, it does not carry any passengers. With these specifications, Pipistrel Nuuva 300 is an outlier when compared to the other top UAM vehicles.

Table 3.9. Pipistrel Specifications.

Vehicle	Range [miles]	Cruise Speed [mph]	Max Cruise Speed [mph]	Payload [lb]	Endurance [h]	Number of Passengers	Propulsion System
Pipistrel Nuuva 300	1,550	100	137	1014	12	0 (Cargo)	Hybrid

### 3.1.2.2 UAM Aircraft Main Characteristics Comparative Analysis for the Top 10+ Subset

The following section compares the range with payload, cruise speeds, endurance, and the number of passengers for the top 10+ vehicles. However, it is noteworthy that some of these vehicles do not have the available data for all the parameters; thus, the comparison results only include the vehicles with the details for the studied parameters.

#### 3.1.2.2.1 Range vs. Payload

Figure 3.48 shows the range and payload for the top 10+ vehicles with different architectures. The wingless multicopter vehicles have a short range of fewer than 50 miles and a payload capacity of about 450 lb, which are among the lowest values compared to other architectures. On the other hand, the lift + cruise vehicles have ranges of up to approximately 1,500 miles and payloads of up to 1,020 lb. The vectored thrust vehicles with a range of about 200 miles and payload up to 1,200 lb are most suitable for moderate range and payload operations. These trends are consistent with those observed in the complete database.

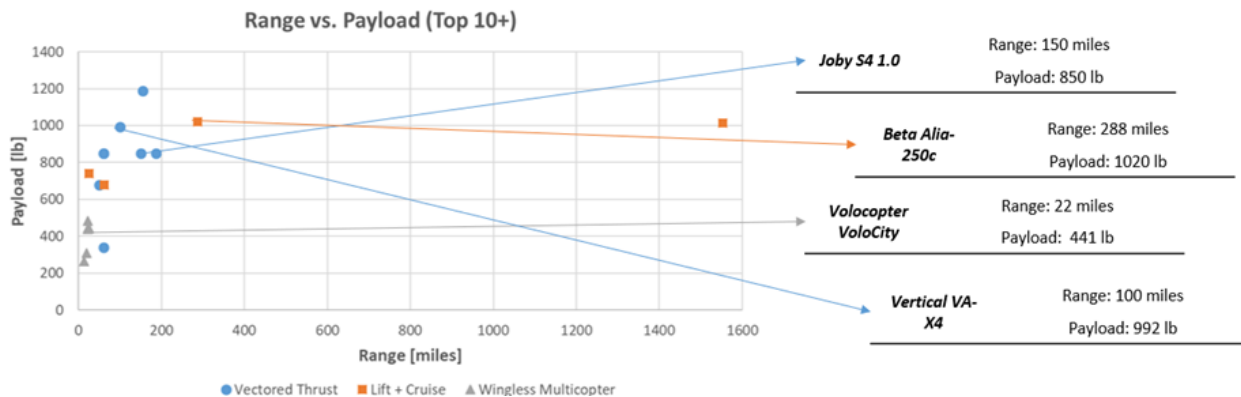

Figure 3.48. Top vehicles – Range vs. Payload.

### 3.1.2.2.2 Range vs. Number of Passengers

Figure 3.49 presents the range and number of passengers for the top 10+ vehicles with different architectures. Wingless multicopter vehicles have a short range of fewer than 50 miles and a transport capacity of 2 passengers, which are among the lowest values compared to other architectures. Lift + cruise vehicles that carry passengers have a similar range when transporting up to 4 occupants. The lift + cruise configuration that doesn't carry passengers has a longer range of about 1,500 miles. The vectored thrust vehicles with a range of about 200 miles and transport capacity of up to 6 people are most suitable for moderate range and a large number of passenger transport operations.

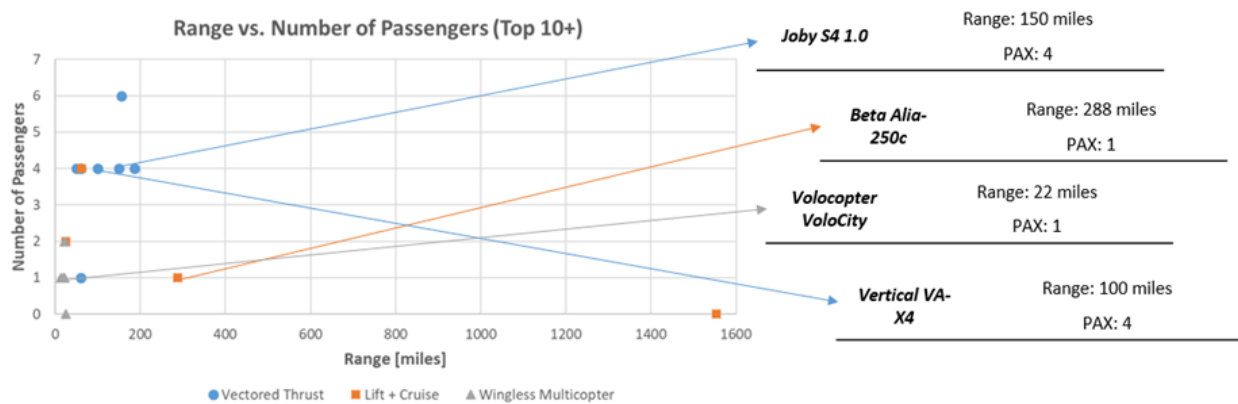

Figure 3.49. Top vehicles – Range vs. Number of passengers.

### 3.1.2.2.3 Range vs. Cruise Speed

Figure 3.50 shows the range and cruise speed for top vehicles with different architectures. The wingless multicopter vehicles have a short range of fewer than 50 miles and a cruise speed of about 60 mph, which are among the lowest values compared to other architectures. Passenger-carrying lift + cruise vehicles have intermediate-range and cruise speed when compared to wingless multicopters and vectored thrust vehicles. On the other hand, the cargo lift + cruise vehicle has a range of up to about 1,500 miles and cruise speeds of 100 mph. The vectored thrust vehicles with a range of about 200 miles and cruise speed up to 180 mph are most suitable for moderate range and cruise speed operations.

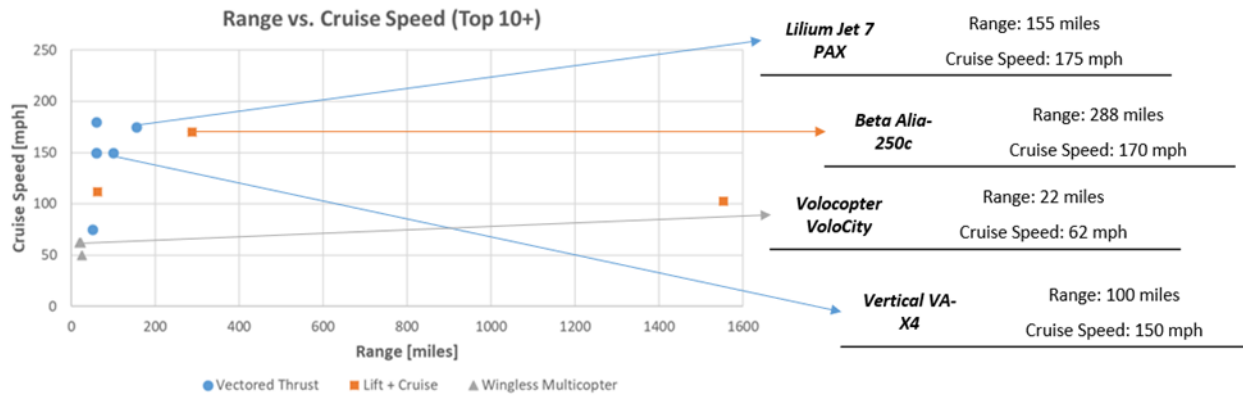

Figure 3.50. Top vehicles – Range vs. Cruise Speed.

### 3.1.2.2.4 Range vs. Endurance

Figure 3.51 shows the scatter plot of range against endurance for the top 10+ vehicles with different architectures. The wingless multicopter vehicles have a short range of fewer than 50 miles and an endurance of about 0.5 hours, which are among the lowest values compared to other architectures. On the other hand, lift + cruise vehicles have shown the capacity to reach ranges of up to about 1,600 miles and endurance of up to 12 hours when in cargo configuration. Vectored thrust vehicles with a range of about 200 miles and endurance of up to 1 hour are most suitable for moderate range and high endurance operations.

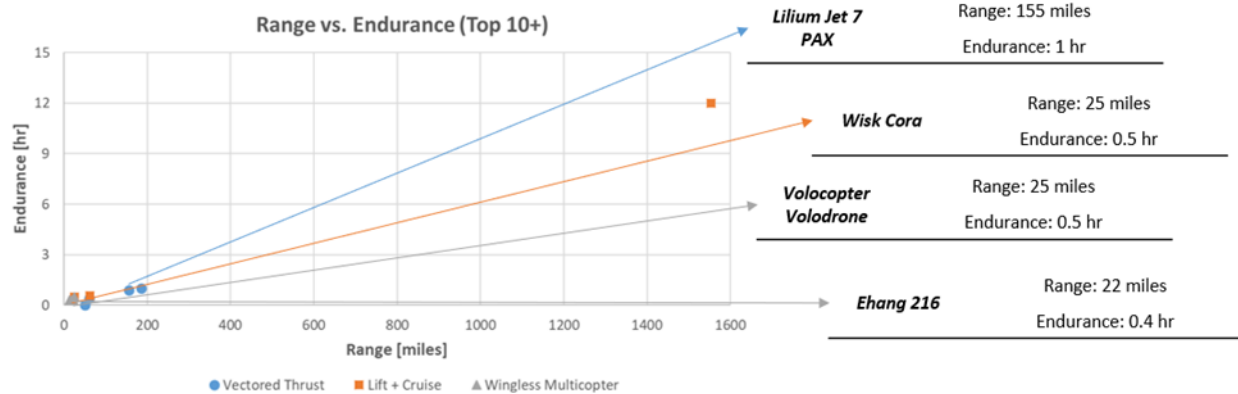

Figure 3.51. Top vehicles – Range vs. Endurance.

### 3.1.3 UAM Classification Conclusions

The results, discussed in Sections 3.1.1 and 3.1.2, provide a detailed overview of the main characteristics of the UAM vehicles being developed. These results allow for identifying trends and differences between the different propulsion methods considered. It is important to note that most UAM vehicles are still in the design phase and not yet ready to enter into service. However, the OEMs are in the race to get their vehicles into the operation phase, which could accelerate the growth of the UAM market in the next few years.

Analyzing the results from both previous sections, Figure 3.52 shows the breakdown of the top 18 and remaining vehicles from the complete database per architecture. As discussed in Section 3.1.2, the top vehicles have a more realistic chance of succeeding in operations, as indicated by their ARI scores (see Table 3.5). The observed trend from Figure 3.52 is that the higher the number of vehicles for a particular architecture from the complete database, the higher number of top vehicles for the same architecture. For example, in Figure 3.52, vectored thrust is the most common, with 89 vehicles and the highest number of top vehicles. On the other hand, electric rotorcraft vehicles have the least number, and at the time of this study, none of them receives an ARI score high enough to earn a place in the top 18 vehicles. This study suggests that the OEMs are most interested in investing in vectored thrust architecture than any other architecture.

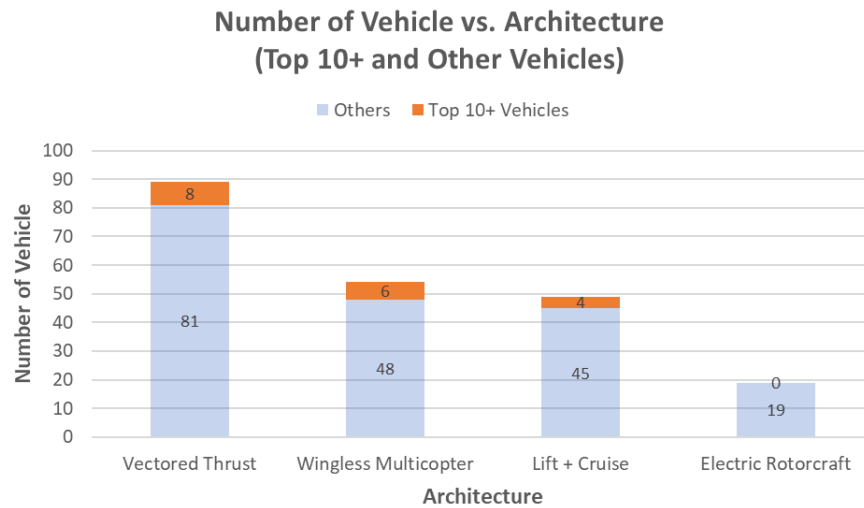

Figure 3.52. Number of vehicles vs. architecture (Top 10+ and other vehicles).

Even though vectored thrust vehicles appear to be the desired choice of architecture based on their high number of top vehicles, Figure 3.53 provides a deeper insight into the competition by showing the max and min ARI scores per architecture. While vectored thrust configuration has the highest ARI score, it also has the lowest minimum score of only 6.7 among the top vehicle architectures. On the other hand, lift + cruise and wingless multicopter architectures have a minimum ARI score of 7.2 and 7.3, respectively, indicating that these architectures also have a reasonable probability of succeeding. Interestingly, wingless multicopter's max and min ARI scores are nearly identical and different by only 0.1. Based on these numbers and considering the many variables presented in the operation competition, currently vectored thrust architectures seem to have the best chance of succeeding, while lift + cruise and wingless multicopter are close behind.

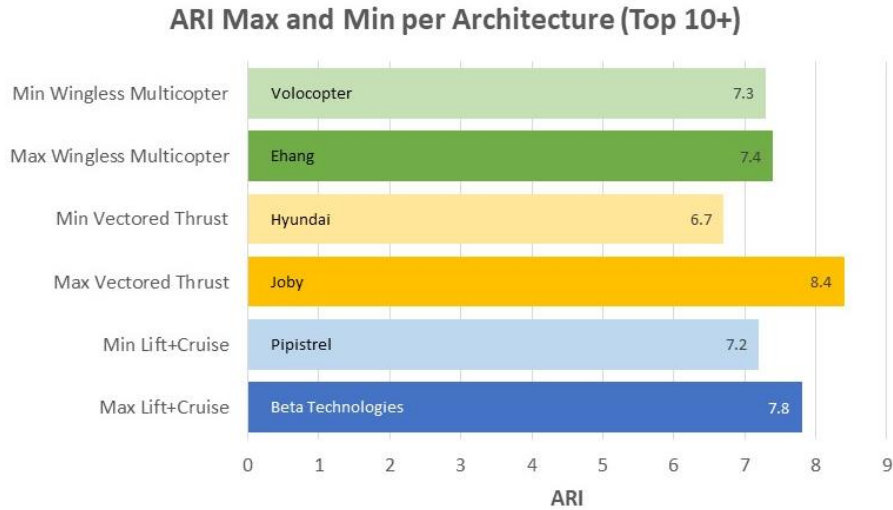

Figure 3.53. ARI max and min per architecture (Top 10+).

Lastly, to understand better the reasons behind the OEMs’ interest in each of the architectures, Figure 3.54 compares their overall performance by showing the normalized values of four critical variables – cruise speed, endurance, max range, and total payload. The normalization was done against the maximum value in each variable category to help visualize and compare these top vehicles easier. Of the 18 vehicles, 6 vehicles (2 per architecture) were selected based on their range's maximum and minimum values. The range variable was used to determine the vehicles because of their availability for most of them. It is essential to point out that the high endurance and max range of the lift + cruise configuration are because of one vehicle (Pipistrel Nuuva 300 – see Table 3.9). However, if Pipistrel Nuuva 300 is treated as an outlier, vectored thrust would show the best performance for all four variables. Vectored thrust vehicles excel in long-distance, fast, and heavy transport missions compared to the other architectures, which is consistent with the high from the OEMs.

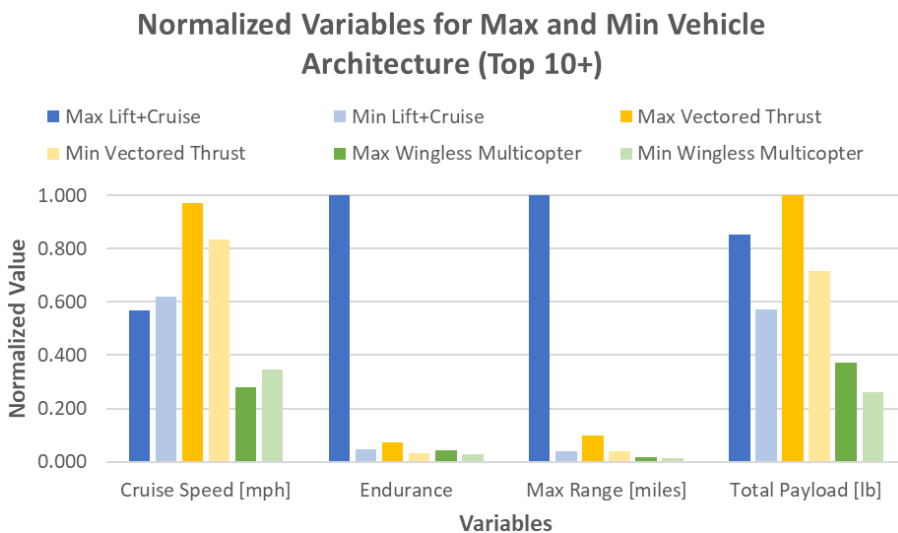

Figure 3.54. Normalized variables for max. and min. vehicle architecture (Top 10+).

To provide more insight into the data, Figure 3.55 shows an alternative analysis of Figure 3.54 by excluding the Pipistrel Nuuva 300 and replacing it with the second best lift + cruise vehicle in terms of range, Beta Technologies Alia-250c (indicated by dark blue color). Following the same approach for normalization as discussed previously, it is observed that vectored thrust vehicles also excel in endurance on top of the payload and cruise speed, with the caveat that there is no available endurance data for the Alia-250c. Even without Pipistrel Nuuva 300, lift + cruise vehicles remains the top performer in term of max range. The wingless multicopter’s position is unchanged in both analyses as the last performer for all categories.

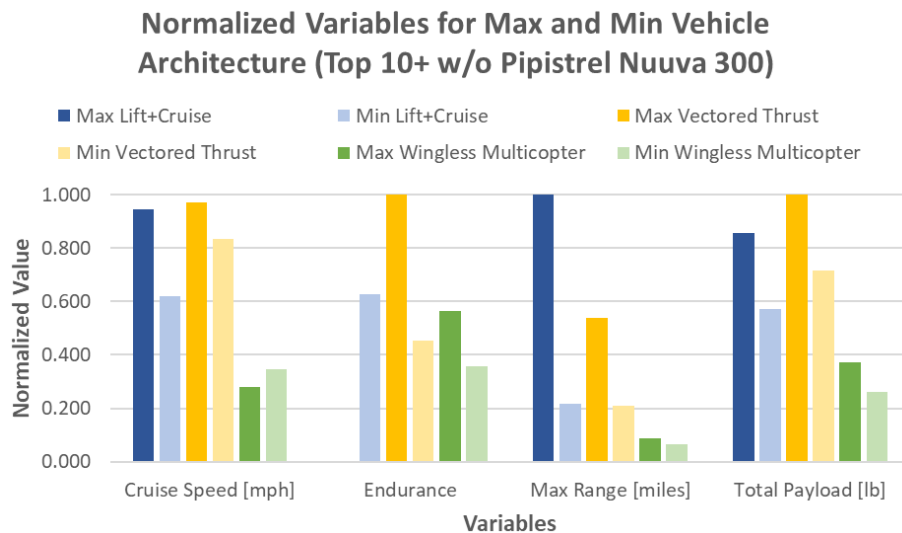

Figure 3.55. Normalized variables for max. and min. vehicle architecture (Top 10+ w/o Pipistrel Nuuva 300).

### 3.2 Task II – Regulatory Standards Applicability

As described by De Florio, “regulations are intended to promote safety by eliminating or mitigating conditions that can cause death, injury, or damage” (De Florio, 2016). For the UAM aircraft industry, the conditions necessary to define these certification regulations and standards are still unknown. As a result, the UAM industry and the regulatory authorities will initially define these regulations and standards based on historical knowledge from traditional commercial aircraft used for both passenger and cargo operations. These regulations and standards are expected to evolve as more information specific to these novel vehicles is obtained.

From the regulatory agencies' point of view, several aspects constitute a challenge to the certification process of the UAM aircraft, including but not limited to the distributed propulsion, the energy storage and distribution systems, the usage of automated systems, and the variety of non-conventional architectures (as presented on Section 3.1). For instance, even though UAM aircraft are mainly designed for VTOL operations and could use the normal rotorcraft standards for type certificate (specified in 14 CFR Part 27 or CS-27), electric battery requirements are not contemplated on those standards. Moreover, some UAM aircraft can be configured from VTOL to Conventional Take-off and Landing (CTOL), depending on the mission type, to increase the

payload weight, e.g., Sabrewing Raegal RG-1 (Sabrewing Aircraft Company), which could require them to use the normal category standards for type certificate (14 CFR Part 23 or CS-23).

This section presents the approach that EASA and the FAA are currently using for UAM-eVTOL aircraft type certificates, as most OEMs will seek certification for their aircraft through those agencies, as shown in Figure 3.5 and Figure 3.31. Also, it discusses technical and regulatory aspects regarding aircraft crashworthiness, battery crash resistance, and noise found at the time of writing this document.

### 3.2.1 Regulatory Agencies Approach for UAM Type Certificate

As defined in 14 CFR Part 3 § 3.5, the term “airworthy” means that an aircraft (or aircraft component) conforms to its type design and demonstrate the requirements for its safe operation. Considering the UAM aircraft's particular characteristics, maintaining the same airworthiness level will be challenging using the current regulations for normal-category airplanes (14 CFR Part 23 or CS-23) and normal-category rotorcraft (14 CFR Part 27 or CS-27). Consequently, this might drive the regulatory agencies to elaborate tailored standards for each aircraft, which will eventually strain the certification process (see Figure 3.56).

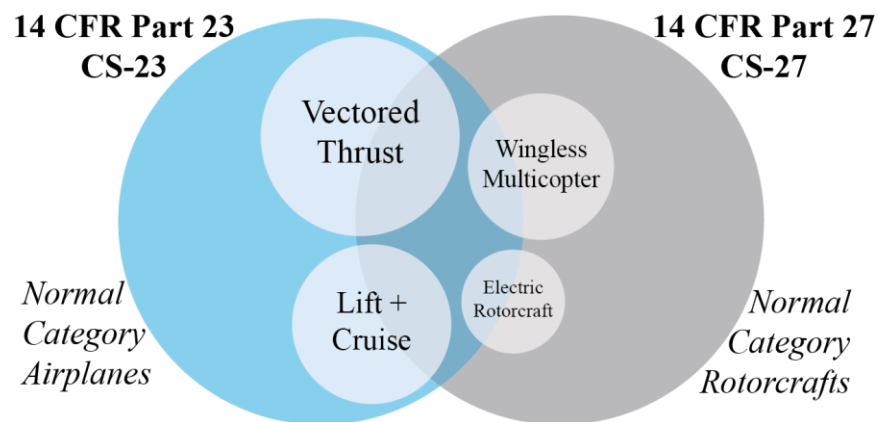

Figure 3.56. UAM architectures with respect to the traditional certification categories.

Currently, the regulatory agencies have worked either on adapting the existing standards to cover the UAM systems, technology, and operations that apply to them or creating new regulations to account for the fundamental differences that these vehicles present from the traditional aircraft. For example, as defined by EASA, “the distinction from conventional aeroplanes is based on the VTOL capability of the aircraft while the distinction from conventional rotorcraft is based on the use of distributed propulsion, specifically when more than two lift/thrust units are used to provide lift during vertical take-off or landing” (European Union Aviation Safety Agency, 2019).

One of the components these novel aircraft present are the engines and propellers, and their path for certification has several unknowns. Besides the technological challenges those components present for certification efforts, there is also the doubt if those components might be certified independently or if they should be certified with the whole aircraft. Although this document does not go into detail about the certification of a particular component, this is a good case scenario to



present the FAA and the EASA approach. While the FAA does not provide a specific path, those components can be certified independently using some sections of Part 33 and some of the accepted ASTM MOCs for Part 23 Amdt. 23-64 (i.e., on ASTM F3064 and F3065). On the other hand EASA, on their Special Condition VTOL.2400(b) (European Union Aviation Safety Agency, 2019) requires “the engine, propeller, and auxiliary power unit to be certified”. Furthermore, on MOC.VTOL.2400(b), from MOC SC-VTOL Issue 2 (European Union Aviation Safety Agency, 2021b), EASA accepts the Special Condition E-19 as a specification to be met by electric/hybrid lift/thrust units that are installed on VTOL aircraft. From this, it is understood that those components can be certified independently

This section briefly discusses the approach that EASA and the FAA use to address the certification of UAM vehicles. Even though both agencies agree on using the traditional certification requirements as a starting point, the former is creating a new set of rules specific for VTOL aircraft, while the latter is modifying the current regulatory framework to readily adapt to new technologies (Thompson, 2018). Since there are several stages of the certification process, the present section will mainly focus on the Type Certificate (TC), which is the foundation for other approvals, including the Production Certificate (PC) and the Airworthiness Certificate. A TC is a design approval issued by the regulatory agencies that demonstrate that a product complies with the pertinent regulations (Federal Aviation Administration, 2005).

#### **3.2.1.1 European Union Aviation Safety Agency (EASA)**

After reviewing more than 150 VTOLs, EASA identified the possibility of applying the same certification standards for traditional airplanes (CS-23) and rotorcraft (CS-27) to UAM vehicles, with some modifications where needed. Using this path to certify these novel vehicles will lead to two significant problems in the future. The first one is that it requires particular considerations to develop the modifications needed for each aircraft, which will not ensure equal treatment for all applicants. The second one is that CS-23 and CS-27 have significant differences. Therefore, depending on which one was used as a certification starting point, some aircraft architectures (or configurations) might present some advantages over others. For this reason, in 2019, EASA published a complete set of dedicated technical specifications in the form of a special condition for Small-Category VTOL aircraft (European Union Aviation Safety Agency, 2019). This document intends to create a consistent certification framework for all applicants, ensuring a comparable level of safety without limiting technical innovation.

The certification requirements introduced on the EASA Special Condition VTOL document (European Union Aviation Safety Agency, 2019) are primarily based on the CS-23 Amdt. 5, with additional elements from CS-27, as well as new elements to address the new technologies presented by these vehicles where needed and establish the safety and design objectives of the aircraft. In this document, EASA also introduced two certification categories for this special condition depending on the nature and risk of the particular VTOL mission; the Basic and the Enhanced. For Category Enhanced, the aircraft will be required to satisfy all the conditions for a continued safe flight and landing and to continue to the original destination, or an alternate vertiport, after failure. For Category Basic, the aircraft will need to meet the controlled emergency landing requirements, e.g., controlled glide or autorotation.

Later, in May 2020, EASA released the first Proposed Means of Compliance with the Special VTOL (MOC SC-VTOL), Issue 1 (European Union Aviation Safety Agency, 2020). This

document provides the means necessary to demonstrate compliance with the safety and design objectives described in the Special Conditions and clarifies the interpretation of these objectives as requested by the applicants. Lastly, based on feedback from industry and other regulatory agencies obtained through the Comment Response Document (CRD) for MOC SC-VTOL Issue 1 (European Union Aviation Safety Agency, 2021a), EASA released in May 2021 an updated version of this proposed means of compliance: Means of Compliance with the Special VTOL (MOC SC-VTOL), Issue 2 (European Union Aviation Safety Agency, 2021b).

Following the same methodology, in June 2021, the Second Publication of Proposed Means of Compliance with the Special Condition VTOL (MOC-2 SC-VTOL), Issue 1 (European Union Aviation Safety Agency, 2021c) was released. This second publication proposes new MOCs and adds some amendments to the MOCs already presented in the previous document. For practical reasons, EASA decided to sequence in two stages the final release of the Second Publication of MOCs with the Special Condition VTOL after receiving the comments from the public consultation. The first stage, released in June 2022 as the Second Publication of Proposed Means of Compliance with the Special Condition VTOL (MOC-2 SC-VTOL), Issue 2 (European Union Aviation Safety Agency, 2022b), contains the final text of all MOCs proposed at MOC-2 SC-VTOL Issue 1 from the CRD for MOC-2 SC-VTOL Issue 1 (European Union Aviation Safety Agency, 2022a). The second stage will address specific sections in a Doc. No. (MOC-2 SC-VTOL) Issue 3, accompanied by a second issue of the CRD. After completion of Issue 3, EASA plans to release a document as Doc. No. (MOC SC-VTOL) Issue 3 with all final MOCs for general convenience. This MOC SC-VTOL Issue 3 was not available at the time of writing this document.

In parallel, the third Publication of Proposed Means of Compliance with the Special Condition VTOL (MOC-3 SC-VTOL), Issue 1 (European Union Aviation Safety Agency, 2022c), was released by EASA in June 2022. This new document proposes new MOCs that add to the ones already published in MOC SC-VTOL and MOC-2 SC-VTOL. Following the same methodology, these MOCs will be open for public consultation. All the comments will be documented in a CRD and discussed/incorporated as required. Finally, EASA plans to issue a new and final MOC SC-VTOL with all the final MOCs for general convenience. Figure 3.57 illustrates the timeline of EASA's MOC for each one of the stages and publications released. On it, the publications that are planned to be released were also included.

Finally, it is crucial to mention that EASA clarifies, in its MOCs documents, that some of the MOCs presented should be considered more as a guideline to help the applicant understand the objective than a definitive MOC.

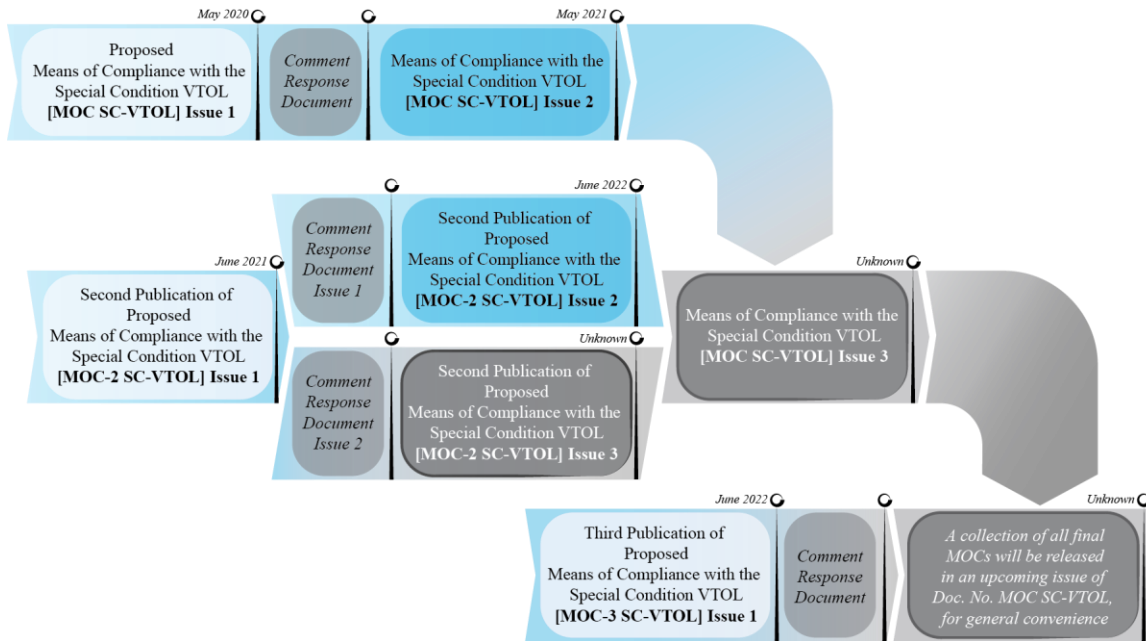

Figure 3.57. EASA’s MOC for special condition VTOL timeline.

### 3.2.1.2 Federal Aviation Agency (FAA)

While EASA is creating a new set of standards to ensure a comparable level of safety for eVTOL certification under a “special condition,” the FAA is modifying existing aircraft regulations to accommodate the new technologies available on UAM aircraft. Therefore, the certification process starts with the FAA establishing the certification basis by identifying the specific 14 CFR parts and amendment levels with which the applicant must show compliance. The designation of applicable regulations is stated in 14 CFR Part 21 § 21.17 Amdt. 21-100 (Federal Aviation Administration, 2017c) and provides two options (see Figure 3.58).

In the first one; 14 CFR § 21.17(a), the applicable requirements are designated to an aircraft, aircraft engine, or propeller that “closely matches the characteristics of a particular airplane or rotorcraft class, along with special conditions to address any differences” (Baker McKenzie, 2022). These requirements can be adjusted by developing special conditions, Equivalent Level of Safety findings, and/or exceptions to address any differences specified by the FAA (Federal Aviation Administration, 2005). Nevertheless, if the existing airworthiness regulations do not contain adequate or appropriate safety standards for the aircraft, aircraft engine, or propeller, because of its novel or unusual design features, the FAA can issue and amend special conditions under 14 CFR § 21.16.

The second option, 14 CFR § 21.17(b), allows special classes of aircraft which do not have airworthiness standards established in 14 CFR to use portions of airworthiness requirements contained in 14 CFR Parts 23, 25, 27, 29, 31, 33, and 35 that the FAA finds appropriate to the specific type design.

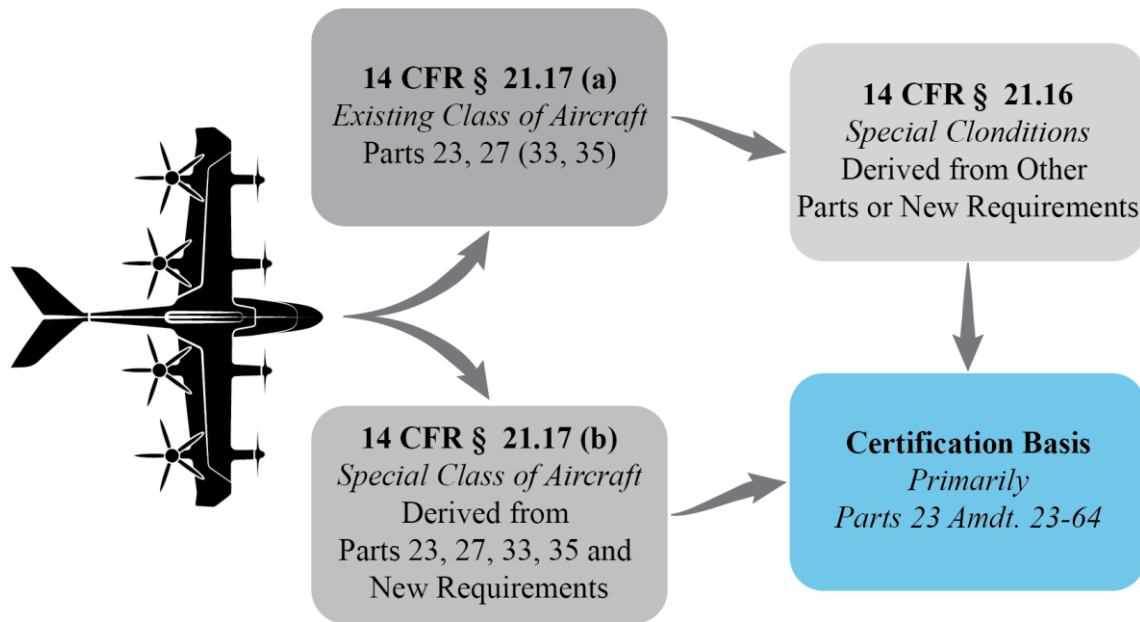

Figure 3.58. Certification basis paths for eVTOLs. Adapted from (ASTM International, 2020).

Initial certification efforts for winged eVTOL airplanes (e.g., Joby Aviation, Archer Aviation, Beta Technologies, and others) involved the implementation of the 14 CFR Part 23 amendment 23-64 (Federal Aviation Administration, 2017b) instead of processes mentioned in 14 CFR § 21.17(b). However, in March 2022, the FAA decided that VTOLs that met the FAA's definition of "powered-lift" could not be certified or operate as airplanes, which means that winged VTOLs will have to go through the same certification path described in 14 CFR Part 21. The rationale behind this decision is that the FAA's Flight Standards Service Office of Safety Standards (AFS) believed aircraft certification needed to match the pilot certification (Hirschberg, 2022).

The FAA implemented amendment 23-64 in 2017 to create a regulatory framework for airworthiness certification that allows the agency to readily adapt to new technologies and provide more flexibility to the applicants on how to show compliance with 14 CFR Part 23 (Thompson, 2018). Amendment 23-64 modifies Part 23 from a prescriptive regulatory system to a performance-based regulatory system (see Figure 3.59). The former gives the applicant the specific technical requirement to show compliance, while the latter offers the desired outcome that the applicant must show.

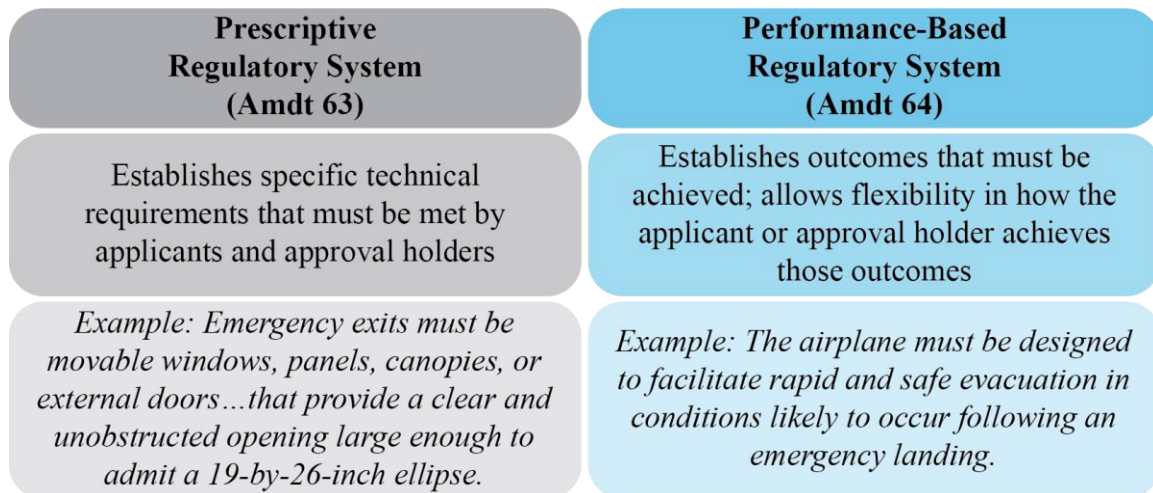

Figure 3.59. Prescriptive vs. Performance-Based Rules. Adapted from (Thompson, 2018).

Since this performance-based approach implemented in 14 CFR Part 23 Amdt. 23-64 does not prescribe the specific means to achieve the safety objectives, the applicant must comply using the accepted MOC presented in 14 CFR § 23.2010. Some of the accepted MOC for Part 23 are described in more detail in AC 23.2010-1 (Federal Aviation Administration, 2017d) and include, but are not limited to:

- Means of compliance previously accepted by the Administrator, e.g., the prescriptive requirements of previous amendment levels of Part 23 (and its corresponding guidance material), or the existing Part 23 Advisory Circulars (AC), if appropriate for the airplane and technology
- Consensus Standards or Industry Standards such as:
  - Radio Technical Commission for Aeronautics (RTCA)
  - SAE International (SAE)
  - ASTM International (ASTM)
  - European Organization for Civil Aviation Equipment (EUROCAE)

At the time of writing this document, some of the most relevant consensus standards for use as MOC to 14 CFR Part 23 Amdt. 23-64 are the ones developed by ASTM Committee F44. In 87 FR 13911 (Federal Aviation Administration, 2022), the FAA announced the acceptance of ASTM Designation F3264-21 (ASTM International, 2021) as MOC to 65 sections of 14 CFR Part 23 Amdt. 23-64. As stated in that document, while some of the MOC presented in ASTM F3264-21 can be accepted as written, others required additional FAA provisions to comply with the requirements described in 14 CFR Part 23 Amdt. 23-64. An example of the changes required by the FAA to the ASTM standard is shown in Figure 3.60. Also, in 87 FR 13911, the FAA provides a side-by-side view that links the applicable 14 CFR Part 23 Amdt. 23-64 regulation to the ASTM F3264-21 sections. Figure 3.61 present an example of the side-by-side correlation provided in 87 FR 13911.

TABLE 1—PART 23 ACCEPTED MEANS OF COMPLIANCE BASED ON ASTM CONSENSUS STANDARDS—Continued

ASTM designation No.	ASTM document title	Changes required for FAA acceptance <sup>5</sup>	Additional information <sup>6</sup>
F3061/F3061M-20 .....	Standard Specification for Systems and Equipment in Small Aircraft.	<p><b>Remove:</b> Tables 1, 3, 4, 5, 13 and 14 .....</p> <p><b>Replace 17.3.1 with the following:</b></p> <p>(a) Each electrical or electronic system that performs a function, the failure of which would prevent the continued safe flight and landing of the airplane, must be designed and installed such that—</p> <p>(1) The function at the airplane level is not adversely affected during and after the time the airplane is exposed to lightning; and</p> <p>(2) The system recovers normal operation of that function in a timely manner after the airplane is exposed to lightning unless the system's recovery conflicts with other operational or functional requirements of the system.</p> <p><b>Replace 17.3.2 with the following:</b></p> <p>(b) Each electrical and electronic system that performs a function, the failure of which would significantly reduce the capability of the airplane or the ability of the flight crew to respond to an adverse operating condition, must be designed and installed such that the system recovers normal operation of that function in a timely manner after the airplane is exposed to lightning</p> <p><b>Remove 17.3.3.</b></p>	<p>Aircraft Type Code compliance matrix tables found in F3061/F3061M-20 are not accepted. Applicability will be determined by the Small Airplane Strategic Policy Section.</p> <p>F3061/F3061M-20 does not contain means for showing compliance to §23.2310 <i>Buoyancy for seaplanes and amphibians</i>. If applying for certification of a seaplane or amphibian, applicants may use the provisions of §§23.751, 23.755, and 23.757 at amendment 23-63 as a means of complying with §23.2310, or may obtain FAA acceptance of a different method of compliance in accordance with §23.2010.</p>

Figure 3.60. Example of the changes required in ASTM standards for FAA acceptance is provided in 87 FR 13911 (Federal Aviation Administration, 2022).

TABLE 2—SIDE-BY-SIDE VIEW OF 14 CFR PART 23 REGULATIONS AND ASTM F3264-21 SECTIONS—Continued

Part 23 amendment 23-64 regulation(s)	ASTM F3264-21 section(s) <sup>7</sup>	ASTM F3264-21 subsection(s) <sup>8</sup>
23.2305 .....	7.2 Landing Gear Systems .....	7.2.1 F3061/F3061M-20 Standard Specification for Systems and Equipment in Small Aircraft.
23.2310 .....	7.3 Buoyancy for Seaplanes and Amphibians	7.3.1 F3061/F3061M-20 Standard Specification for Systems and Equipment in Small Aircraft.
23.2315 .....	7.4 Means of Egress and Emergency Exits ....	7.4.1 F3061/F3061M-20 Standard Specification for Systems and Equipment in Small Aircraft.
23.2320 .....	7.5 Occupant Physical Environment .....	7.4.2 F3083/F3083M-20a Standard Specification for Emergency Conditions, Occupant Safety and Accommodations.
		7.5.1 F3061/F3061M-20 Standard Specification for Systems and Equipment in Small Aircraft.
		7.5.1.1 F3227/F3227M-21 Standard Specification for Environmental Systems in Small Aircraft.
		7.5.2 F3083/F3083M-20a Standard Specification for Emergency Conditions, Occupant Safety and Accommodations.
		7.5.3 F3114-21 Standard Specification for Structures.
		7.5.4 F3117/F3117M-20 Standard Specification for Crew Interface in Aircraft.

Figure 3.61. Example of the Side-by-Side view between the 14 CFR Part 23 Amdt. 23-64 to the ASTM standards, provided in 87 FR 13911 (Federal Aviation Administration, 2022).

Even though 87 FR 13911 presents several FAA-accepted MOC, those do not constitute the only means of complying with Part 23 regulatory requirements. Moreover, depending on the aircraft's design features, the applicant might be required to use different means from those described in 87 FR 13911 or any other MOC accepted by the FAA. In those cases, the applicant may need to propose a new or alternative MOC applicable to their specific designs following the guidelines on AC 23.2010-1. Those new or alternative means of compliance belong to the applicants, and the

FAA does not provide this information to third parties unless specifically authorized by the applicant. Nevertheless, the applicant might consider offering those to a consensus standards body for inclusion in the industry consensus standard. The MOC an applicant intends to use to show compliance to Part 23 Amdt. 23-64 regulations should be listed in a certification plan or compliance checklist as described in Order 8110.4C (Federal Aviation Administration, 2005) and presented to the Project Aircraft Certification Office for acceptance.

*3.2.1.2.1 Regulations Gap Analysis for eVTOL Certification based on FAA Approach*

While the implementation of the 14 CFR Part 23 Amdt. 23-64 provides an initial path for certification of eVTOL aircraft, there are still some areas not covered by the existing regulations due to the uniqueness of some of these novel technologies. For this, committees like the ASTM AC433 were formed. The primary purpose of this committee is to identify those areas that need new content to close the regulatory gaps. In the case of the AC433 committee, they will not be in charge of writing the technical content for a new standard. Instead, they will communicate their findings to the appropriate committee so that the committee can write the technical standard.

During the 9th Annual Electric VTOL Symposium organized by TVF2022, the AC443 presented their findings highlighting that 67% of the ASTM F44 standards apply to the eVTOL as written; 13% of those need some modification or a sensible addition, 2% need major modifications, and that 18% do not apply to eVTOL aircraft (see Figure 3.62). Although useful, the information shown in Figure 3.62 does not provide any specifics on the reasoning behind how the standards were evaluated to determine whether the modifications needed are “major” or not. Through conversations with General Aviation Manufacturers Association (GAMA) representatives, the research team later found that most of the not applicable standard sections were related to the aircraft propulsion type or the power source, while the sections that needed modifications were more related to the aircraft operations or mission type.

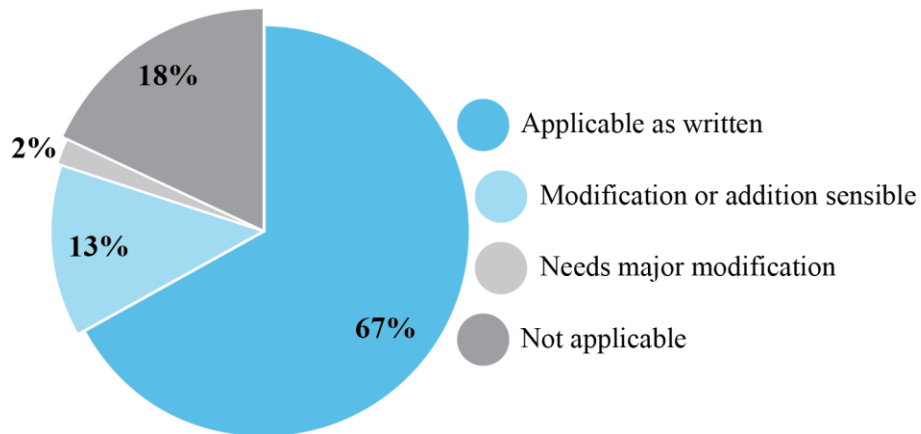

Figure 3.62. 2019 Applicability of ASTM F44 Standards by Sub-Paragraph to eVTOL. Adapted from (Gunnarson, 2022).

In addition, the AC433 committee has identified other committees, besides the ASTM F44 (see Figure 3.63), whose standards might be a viable source for UAM aircraft certification. For example, the standards developed by the ASTM F38 committee could be implemented when addressing the issues to design, performance, and safety monitoring for unmanned aircraft, while

the standards developed by the ASTM F39 committee can be used for electric propulsion units and the integration of electric motors into an aircraft.

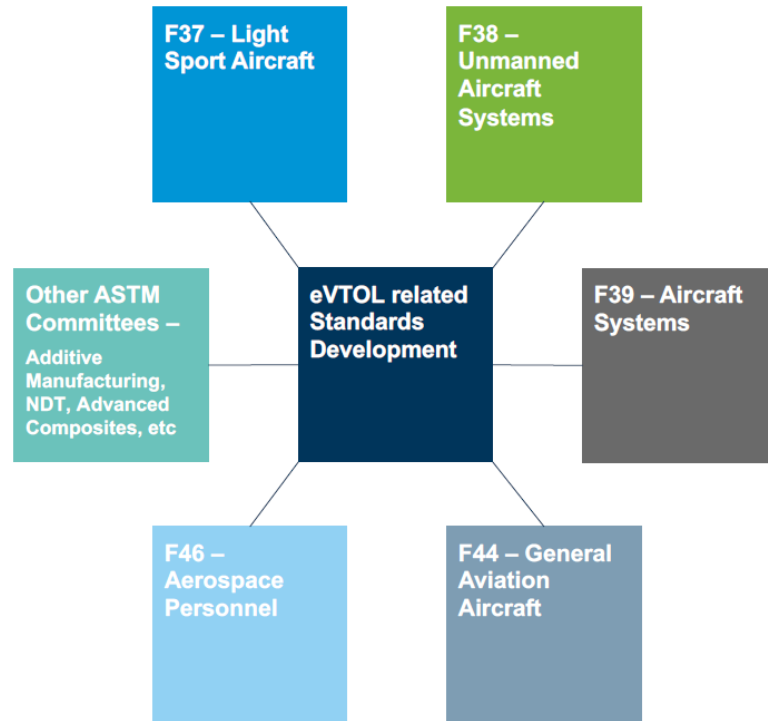

Figure 3.63. Aviation sector committees (Gunnarson, 2022).

### 3.2.2 eVTOL Crashworthiness

Traditionally, crashworthiness requirements for normal-category airplanes and rotorcraft have been derived from statistical distribution studies based on historical data from accidents, such as the one presented by Coltman et al. (1985). Based on the type of operation of a UAM aircraft, it could be possible to implement those crashworthiness requirements despite architectural differences between conventional and UAM aircraft. In this order of ideas, a wingless UAM aircraft might comply with the requirements and use the MOC defined in 14 CFR §§ 27.561 and 27.562 (or EASAs CS-27 §§27.561 and 27.562) for normal category rotorcraft in an emergency landing condition.

However, the variety of technologies and aircraft architectures prevents UAM aircraft from using the same certification approach. CTOL and VTOL-capable UAM aircraft require a different approach in which the requirements will better represent the emergency landing conditions.

The “how to define the right conditions” becomes ambiguous because the requirements defined for Part 23 (normal category airplane) and Part 27 (normal category rotorcraft) aircraft exhibit a big difference between them. For example, note that the ultimate static loads for Part 23 (14 CFR § 23.561 Amdt 23-62) and Part 27 (14 CFR §27.561 Amdt 27-32), summarized in Figure 3.64, present significant differences. In some cases, those differences are as high as three times the load required by the other category. Furthermore, there are conditions where the load values are undefined for both aircraft, e.g., downward and rear cases for items of mass in the cabin (see Figure 3.64(a)) or rear case for occupants (see Figure 3.64(b)).



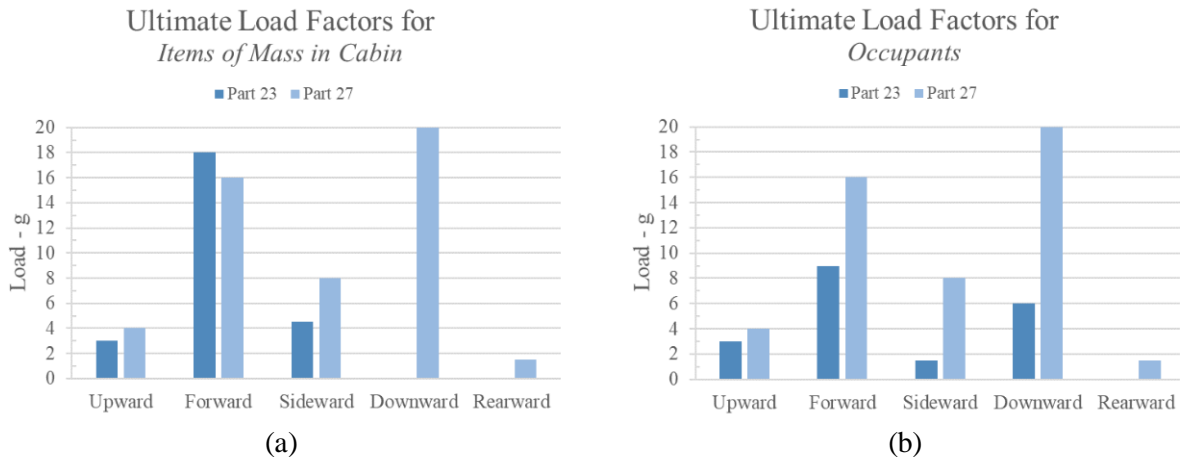

Figure 3.64. Ultimate load factors for (a) items of mass in the cabin and (b) occupants. Data collected from 14 CFR §§ 23.561 Amdt. 23-62 and 27.561 Amdt. 27-32.

Similarly, requirements for dynamic conditions expected during an emergency landing (defined in 14 CFR §§ 23.562 Amdt 23-62 and 27.562 Amdt 27-32) exhibit significant differences regarding pulse accelerations that a seat design or other seating devices must comply with. For example, the peak acceleration required for Part 27 aircraft is double that of Part 23 aircraft at locations other than the first row for Test 1, as shown in Table 3.10.

Table 3.10. Dynamic Test Requirements. Data Collected from 14 CFR §§ 23.562 Amdt 23-62 and 27.562 Amdt 27-32.

DYNAMIC TEST REQUIREMENTS	PART 23		PART 27
	First Row	Other Rows	
<b>TEST 1 – Horizontal Plane of the Aircraft</b>			
Test Velocity – ft/sec (m/s)	31 (9.5)		30 (9.2)
Seat Pitch Angle – Deg.	60		60
Seat Yaw Angle – Deg.	0		0
Peak Deceleration – g	19	15	30
Time to Peak – s	0.05	0.06	0.031
Floor Deformation - Deg.	None		None
<b>TEST 2 – Vertical Plane of the Aircraft</b>			
Test Velocity – ft/sec (m/s)	42 (12.8)		42 (12.8)
Seat Pitch Angle – Deg.	0		0
Seat Yaw Angle – Deg.	±10		±10
Peak Deceleration – g	26	21	18.4
Time to Peak – s	0.05	0.06	0.071
Floor Deformation - Deg.	10 Pitch/10 Roll		10 Pitch/10 Roll

Without having additional information on the conditions UAM aircraft will undergo during an emergency landing, specific requirements or MOC for those vehicles cannot be defined. Therefore, regulatory agencies have used a combination of current and historical requirements for normal-category airplanes (Part 23) and normal-category rotorcraft (Part 27) to define the initial MOC for UAM aircraft. This approach is especially evident in the case of EASA, where specific MOC from

CS-23 Amdt. 4 and CS-27 Amdt. 6 are accepted for UAM aircraft (eVTOLs) with some modifications, as shown in Figure 3.65 and Figure 3.66.

**MOC VTOL.2270(a) and (c) Emergency landing conditions: General considerations**

This MOC provides a set of general design conditions that, when used in their entirety, are accepted to ensure adequate protection of occupants against injuries that would prevent egress in an emergency landing.

- (a) CS 27.561(a) Amdt. 6 is accepted as a means of compliance.
- (b) CS 27.561(b) Amdt. 6 is accepted as a means of compliance with the addition under subparagraph (3)(ii) of a 18 g ultimate inertial load factor in the forward direction for CTOL aircraft.
- (c) CS 27.561(c) Amdt. 6 is accepted as a means of compliance replacing “rotors, transmissions and engines” by “lift/thrust units, transmissions and energy storage systems”.
- (d) CS 27.561(d) Amdt. 6 is accepted as a means of compliance replacing “fuel tanks” by “energy storage systems”.
- (e) For CTOL, CS 23.561(d) Amdt. 4 is accepted as a means of compliance.

Figure 3.65. Emergency landing conditions: general considerations section from EASAs MOC SC-VTOL Issue 2 (European Union Aviation Safety Agency, 2021b).

**MOC VTOL.2270(b)(1) Emergency landing dynamic conditions**

This MOC provides a set of general design conditions that, when used in their entirety, are accepted to ensure adequate protection of occupants against injury in dynamic conditions that are likely to occur in an emergency landing.

- (a) CS 27.562(a) Amdt. 6 is accepted as a means of compliance.
- (b) CS 27.562(b) Amdt. 6 is accepted as a means of compliance under the following conditions:
  - (1) CS 27.562(b)(1) Amdt. 6 is accepted as a means of compliance, noting that the 30 g at seat attachment level was based upon the typical underfloor structure of a conventional rotorcraft. Therefore the 30 g is only valid if the structure underneath the seats has equal or better damping characteristics than a conventional rotorcraft. If specific design features are integrated, less than 30g at the seat may be acceptable based on analysis supported by tests
  - (2) CS 27.562(b)(2) Amdt. 6 is accepted as a means of compliance with the following addition: For CTOL peak floor deceleration should occur in not more than 0.05 seconds after impact and should reach a minimum of 26 g. For CTOL seat/restraint systems not being in the first row, peak deceleration should occur in not more than 0.06 seconds after impact and should reach a minimum of 21 g.
  - (3) CS 27.562(b)(3) Amdt. 6 is accepted as a means of compliance.

Figure 3.66. Emergency landing dynamic conditions section from EASAs MOC SC-VTOL Issue 2 (European Union Aviation Safety Agency, 2021b).

As the FAA certification approach for UAM aircraft relies "mostly" on the flexibility provided by the new performance-based 14 CFR Part 23 Amdt. 23-64, the path for UAM aircraft certification is unclear because specific requirements are not provided. Although the applicant can use the accepted MOC by the FAA for Part 23, such as the ones presented in ASTM F3264-21 (ASTM International, 2021), there are scenarios where the accepted MOC for Part 23 does not fully cover the particular conditions for UAM aircraft. For instance, note that requirements established in 14

CFR § 23.2270 Amdt. 23-64 (Federal Aviation Administration, 2017b), shown in Figure 3.67, do not provide a clear definition of the emergency landing condition. Instead, those requirements generate more questions for the applicants, such as *what are the conditions and loads likely to occur in an emergency landing for a UAM aircraft?*

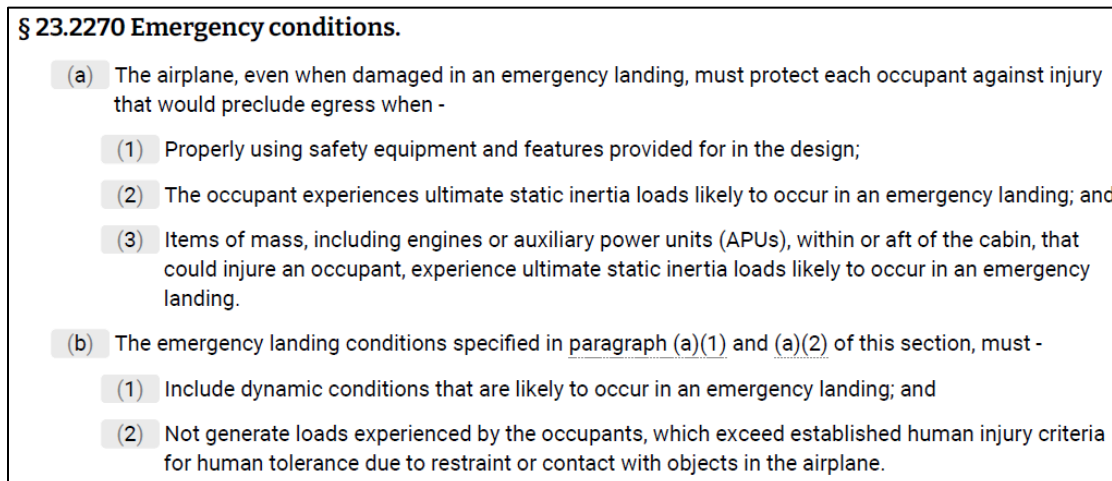

Figure 3.67. Emergency conditions section from 14 CFR Part 23 § 23.2270 (Federal Aviation Administration, 2017b).

From the requirements stated in 14 CFR §§ 23.2270(a)(2) and (b)(1) Amdt. 23-64, it can be interpreted as the applicant should first define the expected loads their aircraft will experience during an emergency landing based on aircraft architecture and mission type, among others, before using the accepted MOC for Part 23 Amdt. 23-64. However, even within the same aircraft architecture, accepted conditions might differ, e.g., the accepted survivable impact velocity change, presented in Figure 3.68., for the army, navy, and civil rotorcraft. This approach will require a constant discussion between the regulatory agencies and the applicant over the required conditions for each aircraft, which will delay the certification process and increase its cost.

On the other hand, SAE International has been developing the performance standards for Passengers & Crew Seats in AAM Aircraft under AS6849, dependent on AS8049D. Although still in development, the preliminary document provides some topics of interest. The first is creating a new category (from here on, referred to as Type D) exclusive to AAM aircraft seats, divided into three subcategories depending on the aircraft operation; CTOL, VTOL or CTOL, and VTOL. The load factors for each subcategory are defined based on the existing conditions for airplanes and rotorcraft. One of the sections presented in the AS6849 discusses the relevance of including part of the aircraft structure if it is a relevant factor for the energy absorption of the event and affects the occupant protection levels.

Another topic presented in those preliminary standards is the Anthropomorphic Test Devices (ATDs) required for testing. Traditionally, the implementation of the FAA HIII ATD for seat testing was optional, and the use of the HIII ATD was the most commonly used one. However, the path AS6849 proposes requires FAA HIII ATDs for Type D seat testing. With this change, SAE

International also brings the Neck Injury criterion (Nij), an injury criterion that the aircraft industry has only used on specific configurations or special conditions.

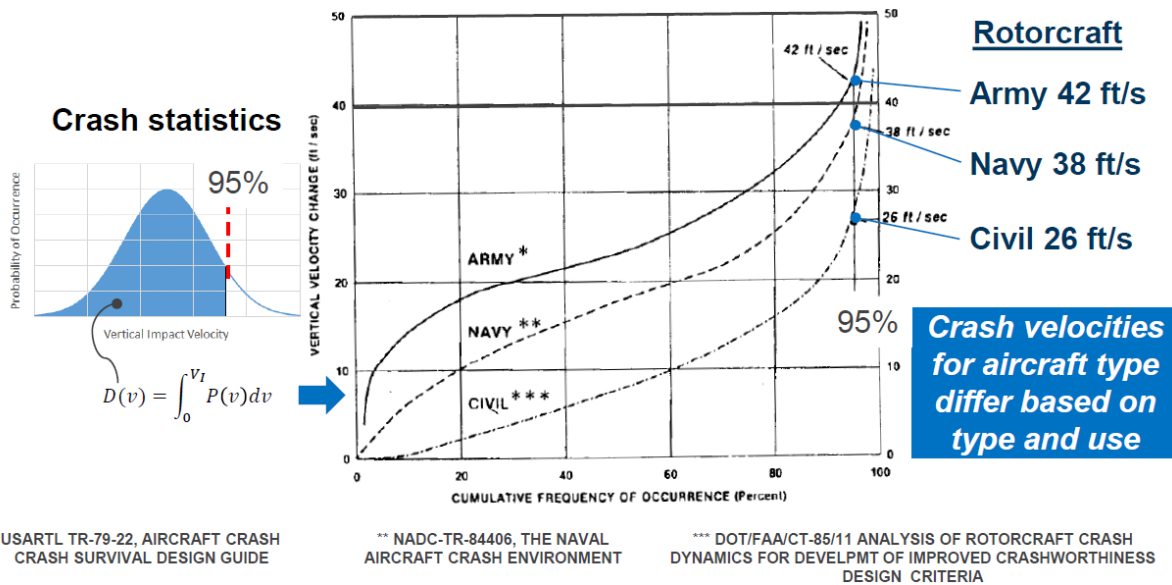

Figure 3.68. Comparison of survivable impact velocity changes for Army, Navy, and Civil rotorcraft. Obtained from (ASTM International, 2020).

### 3.2.3 Battery Crashworthiness

As global regulations move toward cleaner energy sources to reduce pollution, different sectors, such as the automotive and aircraft industries, have been working on implementing new power sources to reduce emissions (e.g., Hydrogen fuel cells and electric batteries (mainly lithium-ion)). The recent technological advances in the development of electric batteries, especially in size and weight reduction while improving capacity, have made these power sources an appealing substitute for traditional fossil fuels. As presented in Section 3.1.2, 94% of the Top UAM aircraft registered on the VTOL Database implement an electric propulsion system, and the remaining 6% use a hybrid (electric and internal combustion) propulsion system (see Figure 3.29).

As briefly mentioned in previous sections, one of the main areas of concern for UAM aircraft certification is the implementation of those new power sources. For this reason, a literature review of the current standards of electric batteries was conducted and summarized in this section. This literature review will focus on the mechanical evaluation (see Figure 3.69) of batteries and battery systems in (possible) scenarios obtained during a survivable emergency landing.

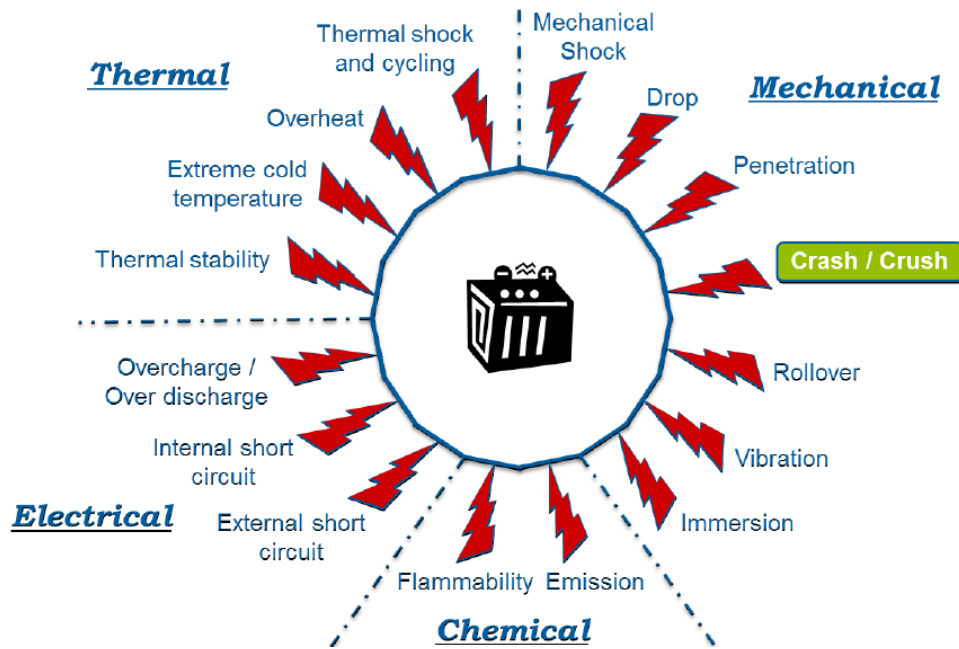

Figure 3.69. Abuse tests for batteries as per different standards and regulations. Obtained from (Kotak et al., 2021).

### 3.2.3.1 Drop Test

On the MOC SC-VTOL, Issue 2 (European Union Aviation Safety Agency, 2021b), EASA presents the crash resistance requirements for energy storage to provide the occupants sufficient time to evacuate or be extracted from the aircraft following a survivable emergency landing condition on the land. Based on the requirements for fuel tanks established in CS 27.952 Amdt. 6, MOC VTOL.2325(a)(4) can be complemented or adapted accordingly depending on the energy source used. One of the requirements presented in both standards consists of a drop test, which releases the energy system from 50 ft onto a flat, non-deforming surface. In addition, the test should include the representative structure immediately surrounding the energy system to assess potential puncture hazards or adverse loading conditions that may lead to the rupture of the energy storage. Among the changes observed in MOC VTOL.2325(a)(4) from the requirements described in CS 27.952 Amdt. 6, two particular conditions stand out. The first one is that in MOC VTOL.2325(a)(4), the energy storage should be charged or filled to its most critical condition, expected during a crash, while in CS 27.952 Amdt. 6 is required for the tank to be filled (with water) to 80% of the maximum capacity. For the second one, the risk of post-crash fire or any other harmful release is evaluated within a considerable time to guarantee the safe evacuation or rescue of the occupants.

Additionally, MOC VTOL.2325(a)(4) specifies the ultimate inertial load factors that each energy storage system shall withstand. Figure 3.70 compares the load factors defined in MOC VTOL.2325(a)(4) and CS 27.952 Amdt. 6, for three scenarios; (1) energy storage in cabins, (2) energy storage located above or adjacent to the crew or passenger compartment, and (3) energy storage in other areas. Note that in the first and third scenarios, the load factors defined on both requirements are the same, except for the addition of a rearward condition and the specification of a particular load factor for CTOL aircraft in the first scenario for MOC VTOL.2325(a)(4). Finally,

in the second scenario, apart from the addition of a rearward condition, the load factors defined were increased in MOC VTOL.2325(a)(4) up to three times compared to CS 27.952 Amdt. 6

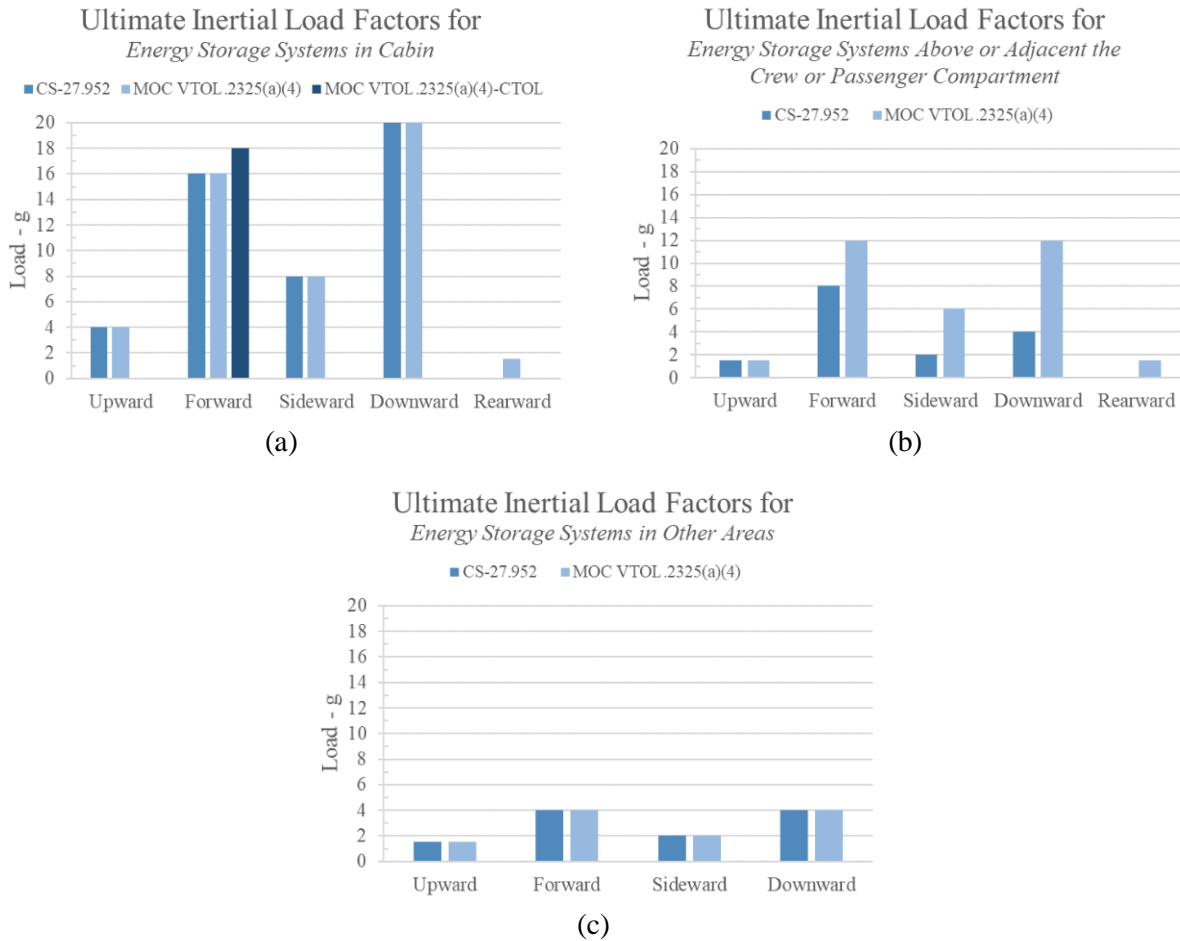

Figure 3.70. Ultimate inertial load factors for energy storage systems in (a) cabin, (b) above or adjacent to the crew or passenger compartment, and (c) other areas. Data collected from CS-27.952 Amdt. 6 and MOC SC-VTOL Issue 2.

From the current FAA accepted means of compliance for 14 CFR Part 23 in 87 FR 13911 (Federal Aviation Administration, 2022), the applicant of an airplane with installed lithium batteries may use the guidance provided by RTCA DO-311A (RTCA, 2017) for certification efforts. Furthermore, the applicant may obtain FAA acceptance of a different method of compliance per 14 CFR § 23.2010, as discussed in Section 3.2.2 for eVTOL crashworthiness certification.

RTCA DO-311A presents the minimum operational performance standards for rechargeable lithium batteries and battery systems (permanently installed on aircraft) to verify and characterize the safety and performance of those power sources. Among the test described in RTCA DO-311A, two are of particular interest; the first one, known as the "Explosion Containment" test, evaluates the effectiveness of the equipment in containing an explosion when one or more cells fail and release combustible gases in the presence of an ignition source. The second one, known as the "Drop Impact Resistance" test, evaluates the resistance of the battery (or battery system) after being dropped to a hard surface from a height of 3.28 ft (1 m). Although the rationale behind the

drop test is not specified, presumably, the test is related to a drop during the handling of the batteries due to the low impact height defined.

Some other standards that use drop tests to evaluate the electric battery systems' performance are the SANDIA Report SAND2005-3123 (Doughty & Crafts, 2006) and the SAE Standards J2929 (SAE International, 2013) and J2464 (SAE International, 2021). Table 3.11 compares the conditions for each test and the Pass/Fail criteria used on them. In addition, the rationale for each test is included in this table when available. Note that most battery drop test requirements involve very short drops that would occur within a cabin or when handling the battery and do not contemplate the dynamic loads and conditions expected during a survivable emergency landing.

### 3.2.3.2 Crush Test

Due to the high deformations expected on the aircraft structure during an emergency landing, the evaluation of the ability of a battery to withstand an impact/crush that may result in an internal short circuit is necessary. While there is no specific mention of this type of testing condition as a requirement in the aerospace industry, this approach is discussed in several standards (including automotive) and presents different variations. This section introduces some of the procedures found in the literature, focusing mainly on assembly levels from battery modules and higher (see Figure 3.71) to present a more component base understanding of the conditions.

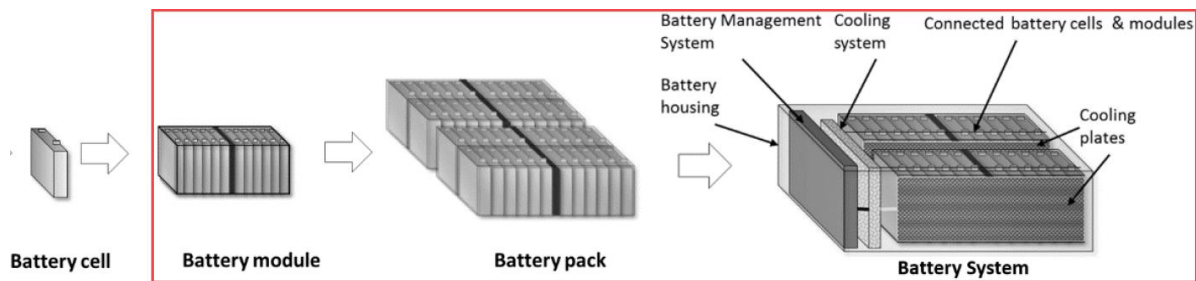

Figure 3.71. Schematic summary of the key components of a battery pack. Obtained from (European Commission et al., 2021).

In general terms, in a crush test, the Equipment Under Test (EUT) (i.e., battery cell, module, or pack) is placed on an electrically isolated flat surface to prevent inducing an additional current path. Later, the EUT is crushed with a textured platen (see Figure 3.72) at a specific velocity until reaching a predefined crush distance or load.

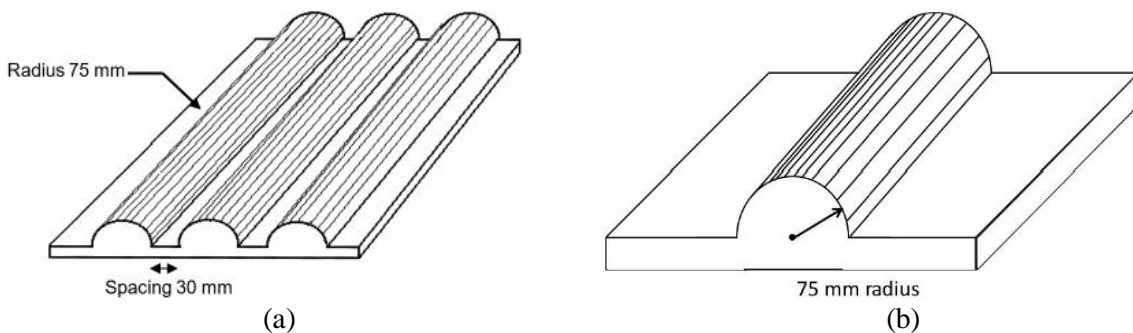

Figure 3.72. Example of a crush textured platen for modules and packs as per (a) SAE J2464 (SAE International, 2021) and (b) SAND2017-6925 (Orendorff et al., 2017).

Table 3.11. Summary of battery drop tests conditions.

Organization	SANDIA	SAE	SAE	RTCA	EASA
<b>Number</b>	3123 FreedomCAR	J2464	J2929	DO-311A	MOC SC-VTOL 2
<b>Year</b>	2005	2021	2013	2017	2021
<b>Specific Test</b>	Drop	Drop Test	Drop Test	Drop Impact Resistance	Drop Test
<b>Rationale</b>	Evaluate credible abuse conditions during the manufacture, assembly, and normal use of the EESS	This condition simulates a service condition where the battery system is removed (or being removed) from the vehicle and is dropped while separate from the vehicle.	This condition simulates a service condition where the battery system is removed (or being removed) from the vehicle and is dropped while separate from the vehicle.	N/A	Survivable Emergency Landing Conditions Loads
<b>Drop Height</b>	≤ 32.8 ft (10 m)	≥ 3.28 ft (1m)	≥ 3.28 ft (1m)	3.28 ft (1m)	50 ft (15.2 m)
<b>Impact Surface</b>	Centered, cylindrical steel object with a radius of 150 mm	Hard flat surface	Non-deformable, horizontally flat surface	Concrete like surface	Non-Deforming
<b>State of Charge</b>	Battery State Of Charge (SOC) shall be at 100% of the maximum	Fully charged state (100% SOC)	The state of charge shall be 95-100% of the maximum level specified by the user/manufacture	Battery Fully Charged per manufacturer's instructions	Charged to the most critical condition expected during a crash
<b>Drop Orientation</b>	Not specified	Most vulnerable orientation	Oriented in such a way to represent the most likely impact orientation based on battery size, shape, installation location, and usage	The EUT should be dropped six times. The six drops shall be initiated from opposite directions of each of the three orthogonal axes of the EUT. Even though the six drops shall be initiated from opposite directions of each of the three orthogonal axes of the EUT, and may land in any orientation	Representative of a typical installation on the aircraft and impact in a horizontal position ±10° with regards to the horizontal axis of the VTOL
<b>Pass/Fail</b>	<i>"It is not the intention of this document to apply acceptance criteria; each vehicle design has its unique requirements and ancillary support systems."</i>	<i>"This document does not establish pass/fail criteria. However, SAE J2929 does define pass/fail criteria for automotive RESS (Rechargeable Energy Storage Systems) safety testing"</i> <i>"It is not the intention of this procedure to establish acceptance criteria since each application has its unique safety requirements"</i>	During the drop test and for a minimum 1-hour post-drop observation period, the battery system shall exhibit no evidence of fire or explosion.	No release of fragments outside of the portable device as a result of a battery failure. No escape from flames outside of the portable device. No emission of gas, smoke, soot, or fluid from a portable device.	No risk of post-crash fire or other harmful releases within a time frame compatible with the rescue of seriously injured occupants. Structural damage should not lead to a fire, leakage of harmful fluids, fumes, or gases Any fire or leakage of harmful fluids, fumes, or gases should be contained for at least 15 min in non-occupied areas and outside the evacuation path Any projectile release should not lead to serious injury to occupants or persons on the ground



Table 3.12 presents a summary of the crush test conditions for three different standards, the SAE J2464 (SAE International, 2021), the SAE J2929 (SAE International, 2013), and the SAND2017-6925 (Orendorff et al., 2017). Note that the maximum load, displacement, and crush velocity varies from standard to standard, from which the selection of the specific test conditions for battery certification lies on the battery manufacturer, and might not be representative of the scenario under consideration. Similar to the pattern found in the drop test conditions, the State Of Charge (SOC) for this test also presents ambiguous conditions as the battery shall be charged to the maximum “which is possible during normal vehicle operation.”

Table 3.12. Crush test summary for three different standards.

	SAE	SAE	SANDIA	
Number	J2464	J2929	SAND2017-6925	
Year	2021	2013	2017	
Specific Name	Crush Test	Battery Enclosure Integrity. Alternative 1	Battery Enclosure Integrity. Alternative 2	Module/Pack Crush
Rationale	<i>This condition simulates contact loads that may occur during a vehicle crash situation.</i>	<i>This condition simulates contact loads that may occur during a vehicle crash situation.</i>	<i>This condition simulates contact loads that may occur during a vehicle crash situation.</i>	<i>Determine the abuse response of a RESS to mechanical insult by crushing to failure</i>
Assembly Level	Modules & Packs	Modules & Packs	Modules & Packs	Modules and Higher
State of Charge	Fully charged state (100% SOC)	Battery SOC shall be at 95-100% of the maximum which is possible during normal vehicle operation	Battery SOC shall be at 95-100% of the maximum which is possible during normal vehicle operation	Tests should be conducted at 100% SOC unless specifically noted otherwise
Max Crush Distance	85% EUT Height	85% EUT Height	85% EUT Height	50% EUT Height
Max. Load	1000x EUT Weight	1000x EUT Weight	100 kN	1000x EUT Weight
Crush Speed	5 mm/min - 10 mm/min	5 mm/min - 10 mm/min	5 mm/min - 10 mm/min	1 mm/min
Pass/Fail	<i>“This document does not establish pass/fail criteria. However, SAE J2929 does define pass/fail criteria for automotive RESS safety testing” “It is not the intend of this proceddure to establish acceptance criteria since each application has its own unique safety requirements”</i>	<i>“During the test and for a minimum 1 hour post-test observation period, the battery system shall exhibit no evidence of battery enclosure rupture, fire, or explosion and shall maintain high voltage to ground isolation no less than 100 Ω/V. Isolation measurement is to be done in accordance with ISO 6469-1, 6.1.3; or equivalent.”</i>	<i>“During the test and for a minimum 1 hour post-test observation period, the battery system shall exhibit no evidence of battery enclosure rupture, fire, or explosion and shall maintain high voltage to ground isolation no less than 100 Ω/V. Isolation measurement is to be done in accordance with ISO 6469-1, 6.1.3; or equivalent.”</i>	<i>“The intent of this manual is not to define acceptance criteria. Specifically, the prescription of specific test plans, step-by-step instructions on executing tests, and pass/fail criteria are outside the scope of this document.”</i>

Kotak et al. (Kotak et al., 2021) discuss the need to augment and harmonize the current regulatory framework for crush testing scenarios. In it, the authors present a comprehensive study on the difference between six (6) different standards (at all battery assembly levels), focusing on the

influence of crush speed, SOC, press position, textured platen (crusher) shape, and dimensions, and the number of testing samples. One of the key findings of the study is that most of the standards are based on quasi-static conditions, which are not representative of realistic dynamic scenarios. Based on several studies found in the literature, Kotak et al. (Kotak et al., 2021) establish that at quasi-static conditions, the EUT will undergo homogeneous deformation within the battery pack, resulting in a random distribution of the battery failure. On the other hand, during a dynamic impact, a concentrated force on particular battery rows was noticed, which resulted in a severe deterioration of the batteries under an equal displacement, implicating higher failure risk.

Additionally, in the same study, Kotak et al. (Kotak et al., 2021), deliberate on the dynamic nature of the battery during an accident event, stating that on the different standards studied, the battery is static, and the crusher moves toward the EUT, while in real scenarios, the battery is moving towards the impact zone. According to the authors, this implies that the loading of the batteries occurs in two (2) different ways: the first one comprises the intrusion of other parts or deformation of the battery, and the second one involves the rapid change of acceleration on the battery due to the collision. While quasi-static testing provides a good approximation for the former, the latter requires a different testing approach. Finally, the authors mentioned the relevance of four (4) key aspects (especially in crush test scenarios); the battery and vehicle construction, the placement of the battery, and the fastening systems.

### **3.2.3.3 Other Tests**

In addition to the drop and crush test presented in previous sections, this section offers some additional tests of interest to provide the reader with a broader understanding of the testing requirements for batteries, using a similar approach in Section 3.2.3.1 for the "*Explosion Containment*" test from RTCA DO-311A (RTCA, 2017).

Section 3.2.3.2 presented an initial discussion on the importance of considering the dynamic characteristics of a collision/impact event during battery testing. One of the aspects mentioned is the difference between a quasi-static approach on the crush test due to the homogeneous deformation versus a more localized force obtained in a dynamic scenario. The procedure for the "*Impact*" test in the Manual of Tests and Criteria (United Nations, 2019) considers the dynamic aspect by dropping a 20 lb (9.1 kg) mass from 2 ft (61 cm) in a controlled manner using low friction sliding track. This test applies to cylindrical cells with a diameter of not less than 0.71 in. (18 mm).

Another aspect introduced in Section 3.2.3.2 was the effect of the rapid change of acceleration obtained in a collision. For this, the "*Shock (or Mechanical Shock)*" procedure found in the Manual of Tests and Criteria (United Nations, 2019), the SAE Standards J2929 (SAE International, 2013) and J2464 (SAE International, 2021), and the SANDIA Report SAND2005-3123 (Doughty & Crafts, 2006) provides the necessary guidelines to evaluate the battery response when subjected to high accelerations. Table 3.13 summarizes the peak loads, pulse duration, and pulse form found on the standards mentioned. Similar to the tests discussed previously, note that there are high discrepancies in the loading conditions between the standards.

Table 3.13. Shock test summary for four different standards.

	United Nations	SAE	SAE	SANDIA
<b>Number</b>	ST/SG/AC.10/11/Rev.7	J2464	J2929	SAND2005-3123
<b>Year</b>	2019	2021	2013	2006
<b>Specific Name</b>	Shock	Shock Tests	Mechanical Shock (Alternative 1)	Mechanical Shock
<b>Rationale</b>	<i>This test assesses the robustness of cells and batteries against cumulative shocks</i>	<i>Simulates inertial loads which may occur during a vehicle crash simulation</i>	<i>Simulates inertial loads which may occur during a vehicle crash simulation</i>	<i>This test assesses the robustness of RESS under shock loads</i>
<b>Assembly Level</b>	Modules & Packs	Cell Level and Higher	Battery System	Module
<b>Peak Acceleration</b>	Cells: 150 g Large Cells: 50 g	25 g	UN Test Manual ST/SG/AC.10/11/Rev.7 or SAE J2464	Low: 25 g Mid-1: 35 g Mid-2: 25 g
<b>Pulse Duration</b>	Cells: 6 ms Large Cells: 11 ms	15 ms		Low: 30 ms Mid-1: 51 ms Mid-2: 60 ms
<b>Pulse Form</b>	Half sine	Half sine		Half sine
<b>State of Charge</b>	Fully charged state (100% SOC)	Fully charged state (100% SOC)	95-100% Max. Normal Vehicle Operation	Fully charged state (100% SOC)
<b>Number of Tests</b>	18 = 3 Reps. On 3 axes in both (+) and (-) direction	18 = 3 Reps. On 3 axes in both (+) and (-) direction	4 = 1 Reps. On 2 axes in both (+) and (-) direction	Not Specified
<b>Notes</b>	Minimum peak acceleration depends on battery mass.	-	It is not required that all evaluation conditions be conducted on a single test sample	-
<b>Pass/Fail</b>	No leakage, no venting, no disassembly, no rupture, and no fire. Additional requirements may apply depending on the SOC evaluated	<i>"This document does not establish pass/fail criteria. However, SAE J2929 does define pass/fail criteria for automotive RESS safety testing"</i> <i>"It is not the intend of this procedure to establish acceptance criteria since each application has its own unique safety requirements"</i>	<i>"During the test and for a minimum 1 hour post-test observation period, the battery system shall exhibit no evidence of battery enclosure rupture, fire, or explosion and shall maintain high voltage to ground isolation no less than 100 Ω/V. Isolation measurement is to be done in accordance with ISO 6469-1, 6.1.3; or equivalent."</i>	<i>"It is not the intend of this document to apply acceptance criteria; each vehicle design has its own unique requirements and ancillary support systems."</i>

### 3.2.3.4 Battery Crashworthiness Conclusions

During the component level review, it was possible to observe the lack of a homogenized regulatory framework for batteries. Before evaluating the behavior of the battery during an emergency landing, it is assumed that the battery will undergo a certification process, similar to what is mentioned in 14 CFR Part 23 in 87 FR 13911, using the guidance provided by RTCA DO-311A. However, the RTCA DO-311A does not present requirements for conditions found on other standards, such as crush, impact, mechanical shock, penetration, or any other mechanical abuse test apart from the drop test. Given the inertial loads present in Table 3.10 and Figure 3.70(a), some additional requirements to those already in place in the RTCA DO-311A could increase occupant safety during an emergency

landing. Additional research efforts are recommended to understand further the applicability of some of these other test standards and what would be the right loading conditions for these novel aircraft.

Also, most standards evaluate the behavior of the battery at quasi-static loads. However, as presented in different studies (Avdeev et al., 2014; Kalnaus et al., 2019; Kalnaus et al., 2018), some components inside the battery structure show high sensitivity to the loading rate. This strain-rate dependency is significantly relevant when the battery undergoes compressive loads due to the porous nature of the polymeric separator membrane (see Figure 3.73) or the electrode coatings, as well as the presence of liquid electrolytes inside the separator pores. For this reason, an increase in the overall stiffness of the battery cells is expected, similar to the one presented by (Kalnaus et al., 2019). In that study, the authors evidenced that the high speeds triggered a long-range deformation that propagated through the entire module containing ten (10) cells, while at low speeds, the visually detectable deformation propagated only through 50% of the module.

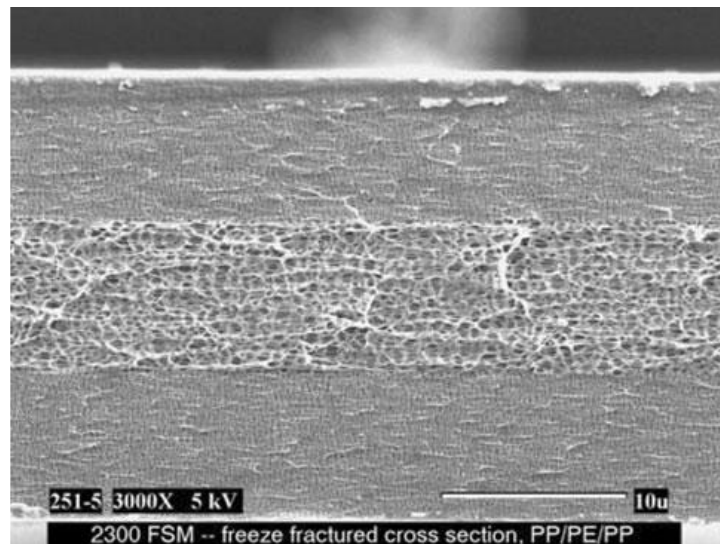

Figure 3.73. Microstructure of a celgard tri-layer separator (cross-section view). Obtained from (Avdeev et al., 2014).

On the other hand, although the SOC in most of the standards studied ranged between 95% - 100%, there are some cases in which the recommended SOC is ambiguous, e.g., the MOC VTOL.2325(a)(4) for the drop test in (European Union Aviation Safety Agency, 2021b) or the SAE J2929 crush test. In the former, the “most critical condition expected during a crash” is presented, while in the latter, “the maximum which is possible during normal vehicle operation” is shown. In either case, no clear guideline or approach to define or determine the most critical condition or the maximum during normal operation. In addition, although not included in the present report, the UN/ECE-R100.02:2013 and the ISO 12405-3:2014 standards recommend that “the SOC should not be in the lower 50% of the normal operating range of the test device” (Kotak et al., 2021). As described in (Doughty, 2012), batteries have the fuel and oxidizer packaged together in the cell, any event that may trigger a rapid chemical reaction could result in a thermal runaway. Since the progression of this reaction is determined by the SOC and the cell design, it is crucial to test the battery at a high SOC for hazard evaluation. A high SOC facilitates the completion of the reaction within the cell (and in battery modules, and packs might propagate to adjacent cells), increasing the fire hazard as presented in (Yi et al., 2019). Further research is required to entirely understand SOC's effect during battery drop tests.

### **3.2.4 Noise regulations and their applicability to UAM vehicles**

#### **3.2.4.1 Introduction**

##### *3.2.4.1.1 Need for noise regulation for UAM vehicles*

With increasing populations and the ever-more affordable road vehicles, traffic congestion has become a significant problem in highly populated communities. For this reason, governments and technology companies have started to look at UAM as a viable passenger and cargo transport option. As the price of traveling by air in cities becomes more affordable, demand is only expected to increase, with an expected compound annual growth rate of 17.28% until 2035 (Mordor Intelligence, 2020). UAM operations will therefore expose many new individuals to aircraft noise.

Aircraft noise can cause community annoyance, disrupt sleep, negatively impact academic performance, and increase the risk of cardiovascular disease in people living near airports (Basner et al., 2017). With UAM operations, these adverse effects will likely affect a more significant portion of the population unless strict requirements are enforced.

Uber Elevate (Uber Elevate, 2016) categorizes aircraft noise as one of the barriers to market feasibility for UAM eVTOL projects. For air mobility in cities to thrive, Uber claims that aircraft noise levels must be low enough to blend with the city noise. To achieve this, Uber sets goals for maximum noise levels and long-term and short-term annoyance and recommends continuously measuring noise levels once the vehicles are in operation.

##### *3.2.4.1.2 Noise Measurement and Common Noise Metrics*

Small, propeller-driven aircraft are certified using the maximum A-weighted sound level,  $L_{Amax}$ . The A-weighting is designed to approximate subjective perceptions of loudness and de-emphasizes the low-frequency range of the sounds. Engineers found that A-weighted sounds corresponded well to human responses to noise independent of intensity (Bennett & Pearsons, 1981). In measuring a noise event with only this single metric, engineers do not capture duration or strong tonal components in the metrics. Moreover, the A-weighting of the sound pressure level does not account for psychoacoustic measures of annoyance. The weighting slightly amplifies sounds between 1,000 Hz and 6,300 Hz while de-emphasizing sounds above and below this range.

Light helicopters are certified using Sound Exposure Level (SEL), an energy average of the sound over a single noise event, averaged over a 1-second interval. For a doubling of duration, the SEL increases by 3 dBA. Using the A-weighting, this metric also accounts for the spectral content. However, it does not account for any dominant tonality that may increase the perceived annoyance in a sound.

Large rotorcraft and tiltrotors are assessed using the Effective Perceived Noise Level (EPNL), a measure of the perceived noisiness of a sound. The EPNL metric converts raw sound pressures into perceived noisiness, which accounts for humans' spectral content and perception. Additionally, there is accounting for the duration of the sound as well as a penalty for discrete tones.

Community noise is often measured using the Day-Night Average Sound Level (DNL), which is an integrated noise metric using the A-weighted sound level. The energy-averaged sound level is penalized by 10 dBA between the hours of 2200 and 0700 to account for the additional detriment that noise can cause during typical sleeping hours. As pointed out by (Rizzi et al., 2020), "Calculation of integrated noise exposure is based on the equal-energy hypothesis, which postulates that the number, level, and duration of noise events are interchangeable contributors to the integrated level,

as long as the total energy remains constant.” Where a single, loud noise event may be considered disruptive, this hypothesis suggests that a large number of quieter noise events can have the same annoyance or other negative consequences if the total energy of the quieter events is equal to the single event. Another parameter to track community noise is the Day-Evening-Night Sound Level (DENL), which breaks down the day hours into day and evening hours. Evening hours are commonly given a 4-hour period and are penalized with 5 dB. Night hours with 10 dB (International Organization for Standardization, 2016). Similarly, Night Sound Level (NL) is defined as the equivalent continuous sound pressure level when the reference time interval is the night.

Additional details on all noise metrics discussed, including calculation methods and approximate relations between various metrics, can be found in the Handbook of Aircraft Noise Metrics (Bennett & Pearsons, 1981).

#### 3.2.4.1.3 *Classification of Rotor Noise*

Rotor noise is commonly divided into two primary categories: discrete frequency noise, which a harmonic series can represent, and broadband noise, which is nondeterministic in nature. Discrete frequency noise can be further subdivided into thickness noise, loading noise, and high-speed impulsive noise. Within the private sector, government, and academia, discrete noise sources have been thoroughly investigated because they are the dominating sources of helicopter noise. On the other hand, based on their architecture and rotor operating conditions, broadband noise is considered an important source of noise for UAM vehicles (Brentner, 2018).

Thickness noise is caused by the displacement of the fluid due to the rotation of the blade (Blake, 2017). A depiction of this phenomenon is shown in part (a) of Figure 3.74. As a result of the repetitive motion, sound wave pulses are created with frequencies related to the Blade-Passing Frequency (BPF), which depends on the rotor Revolutions Per Minute (RPM) and the number of blades on the rotor.

Loading noise is associated with the distribution of forces on the surfaces of the rotary wing (See Figure 3.74(b)). Because of the rotation of the blade, lift and drag forces are constantly accelerating, which is what causes noise (Brentner, 2018). In addition, loading noise includes the effect of Blade-Vortex Interaction (BVI) and any other unsteady loading associated with the blade's rotation, for example, the force differential experienced as the blade rotates through the advancing and retreating sides. This source of noise is dominant in rotors operating at low-tip speeds.

High-speed impulsive noise is associated with the existence of shock waves and transonic flow (See Figure 3.74(c)). The rotor must operate with high tip speeds for this phenomenon to occur. For these reasons, high-speed impulsive noise depends on the size of the rotor and the operating RPM.

Broadband noise is non-deterministic loading noise and is composed of turbulence ingestion noise and self-noise (See Figure 3.74(c)). Turbulence ingestion strongly depends on ambient conditions (George & Chou, 1984), and self-noise is composed of trailing edge noise due to turbulence in the boundary layer, blade-wake interactions, and other self-induced turbulence noises.

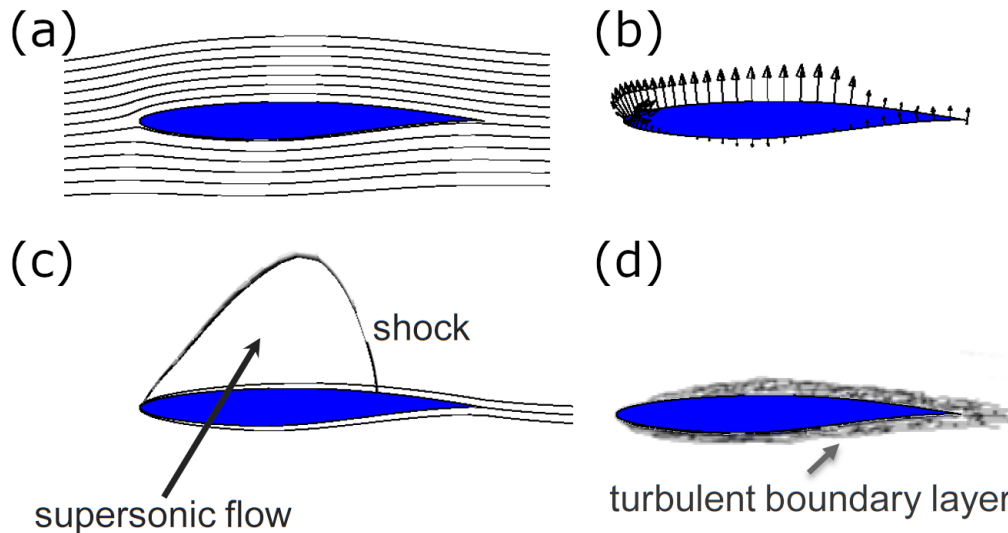

Figure 3.74 Flow phenomena linked to various rotorcraft noise sources (Brentner, 2018).

#### 3.2.4.1.4 Community Acceptance and Annoyance

Current noise certification methods utilize three primary noise metrics: the maximum A-weighted sound level,  $L_{Amax}$ ; the SEL,  $L_{AE}$ ; and the EPNL,  $L_{EPN}$  (Federal Aviation Administration, 2011). These metrics have been used for several decades and have been reasonably successful in capturing the critical parameters for annoyance (Ollerhead, 1982). Authorities may be able to use one of these metrics to certify UAM vehicles, though these models are older than the models currently used in the automotive and appliance industries. While some literature points to the benefits of metrics of increased complexity, there is no universal agreement on the utility of certain metrics, and direct annoyance studies of UAM vehicles are not yet commonly available for assessment (More, 2010). Researchers have conducted significant research into key noise characteristics to assess their predictive capability for annoyance. Most of the work that is directly pertinent to aircraft has been performed using rotorcraft, which, while not directly a substitute for UAM vehicles, represents the largest category of aircraft broadly similar to UAM.

Researchers have identified sound characteristics that, beyond the perceived loudness of a sound, are believed to potentially contribute to the annoyance. These include:

- Fluctuation Strength – variations in the loudness of a sound over time. Some authors use this term to encapsulate both low-frequency variations up to about 16 per second and high-frequency fluctuations between 50 and 90 per second (More, 2010). More commonly, the low-frequency modulations are considered fluctuation, while the higher-frequency variations are referred to as roughness (Krishnamurthy et al., 2018; Zwicker & Fastl, 1999).
- Impulsiveness – Impulsiveness characterizes rapid, audible level changes in a sound. Examples of these include hammer blows or gunshots.
- Roughness – Similar to fluctuation strength, roughness characterizes changes in loudness over time. The difference is that roughness characterizes higher-frequencies, above 15 Hz and below 300 Hz, with a maximum perception of around 70 Hz. At higher frequencies, the

listener is likely to perceive three distinct tones rather than fluctuations (Zwicker & Fastl, 1999).

- Sharpness – This is a measurement of how much of a sound’s energy is located in the higher frequencies for a given loudness (Zwicker & Fastl, 1999).
- Tonality – Tonality accounts for the presence of distinct and prominent tones in a noise. The EPNL metric contains some accounting for this by adjusting the loudness of the 1/3 octave bands based on the presence of prominent tones.

Most studies on the correlation between sound quality metrics and annoyance have been performed on modified or newly created sounds in laboratory settings. Some of these tests have primarily interpolated characteristics from measured data (Krishnamurthy et al., 2018; More, 2010), while others have utilized synthetic sounds that were not directly tied to measured noise events (Rajala & Hongisto, 2020). Multiple investigations concur that loudness is the most significant factor in annoyance (Angerer et al., 1991). However, there is no consensus on the role of the remainder of the sound quality metrics.

More’s (2010) study relying primarily on sounds developed from CTOL jet aircraft identified tonality as the second most important factor to annoyance and that roughness contributed slightly. The author further noted that sharpness and fluctuation strength did not correlate well with annoyance over the range of values tested. More did note that many of the respondents commented on the variations in noise strength when describing the sound qualities. The variation in fluctuation strength based on the CTOL aircraft may have been insufficient to capture its contribution to annoyance. Sharpness was not addressed in this study.

A recent study on rotorcraft noise annoyance manipulated a baseline audio of an AS350 helicopter to generate 105 sounds similar to those generated by helicopters to study the impact of the sound quality metrics (Krishnamurthy et al., 2018). Using multiple linear regression to determine significant metrics, the authors identified the sharpness of the sound as being the most significant, followed in order by tonality and fluctuation strength; impulsiveness did not correlate well with subject annoyance, and roughness was not actively studied. When considering the impulsiveness, the attempt was to understand the significance of blade-vortex interaction (BVI). The authors suspected after analysis that BVI-driven annoyance is likely due to the loudness increase rather than the sound's impulsivity (Krishnamurthy et al., 2018).

Contrary to Krishnamurthy et al.'s findings, many European regulations prescribe penalties for impulsive sounds. Using synthetic sounds, Rajala and Hongisto (2020) studied the impact of the onset rate of an impulse on the subjective annoyance. The noises generated had impulses spaced out rather significantly, with varying onset rates for two different frequency spectra – one with a larger high-frequency content. The observed annoyance penalties were found to be as large as 8 dBA. It should be noted that the impulsive sounds used were spread out significantly, with relatively low-levels of noise between the impulses, which is rather different from the expected aircraft noise.

The regular, periodic noise generated by rotorcraft is often associated with an increase in annoyance, whether due to impulsivity, tonality, or other considerations. Therefore, a Psychoacoustic investigation was conducted, investigating the potential benefits of uneven blade spacing for a helicopter. While the study indicated that modulated blade spacing of main rotors did not generate the desired annoyance reduction, there was some evidence that Roughness contributed significantly



to the annoyance during simulated approach conditions and fluctuation strength did so during simulated flyover tests (Edwards, 2002).

The reviewed research on psychoacoustic measures highlights the ongoing need to investigate the more complex models that include additional sound quality metrics. Consistent evidence implies that loudness, tonality, and either one or both of fluctuation and roughness play a significant role in annoyance, with loudness the largest contributor. Sharpness and impulsiveness may contribute, but there is some conflicting data on both metrics. One current rotorcraft metric, EPNL, does account for loudness and tonality, while the other, SEL, only accounts for loudness and duration (not a sound quality metric), not tonality.

While beyond the primary scope of this investigation, it is important to consider the end goal of aircraft noise certification: a decrease in environmental impact and minimization of community annoyance. When considering revisions to existing regulations, additional complexity or expense of certification should only be considered if they positively impact these criteria.

In the late 1970s, Schultz (1978) analyzed a survey of social surveys on noise and annoyance to determine if there existed any consistency to human annoyance levels to varying noise levels. By focusing on only those persons who were highly annoyed by a sound (the top 27% to 29%, depending on the scale and wording of the survey), Schultz was able to identify a trend that correlated annoyance with the DNL in varying cities. As it has come to be known, the Schultz curve estimated that half of the residents would be highly annoyed with an outdoor DNL of 80 dB. Street, freeway, railway, and aircraft noise were all represented in the surveys assessed, and no consistent penalty for any one of these noise sources was shown consistently across the data.

A subsequent study from the Federal Interagency Committee on Noise (FICON) performed in 1992 identified a curve similar to the one developed by Schultz, identifying that 12.3 percent of the population in the U.S. would be ranked “highly-annoyed” at a DNL of 65 dB, marginally lower than the original Schultz curve (Federal Interagency Committee on Noise, 1992). Figure 3.75 shows the Schultz curve and the updated relationship. The regulatory standards at the time appeared to be supported by this, with a DNL of 65 dB or lower being deemed acceptable, with additional noise attenuation on buildings required in areas with DNL between 65 dB and 75 dB.

Uber Elevate (2016) has set a noise level goals for UAM operations to thrive in their expected operation environments. These are as follows:

- Noise level objective: 62 dB  $L_{Amax}$  at 500 ft altitude (about half the sound level of a truck driving in a residential area and one-quarter of the noise produced by the smallest four-seat helicopter currently on the market)
- Long-term annoyance: about 1 dB increase in DNL
- Short-term annoyance: a maximum 5% increase in nighttime awakenings in their surrounding communities

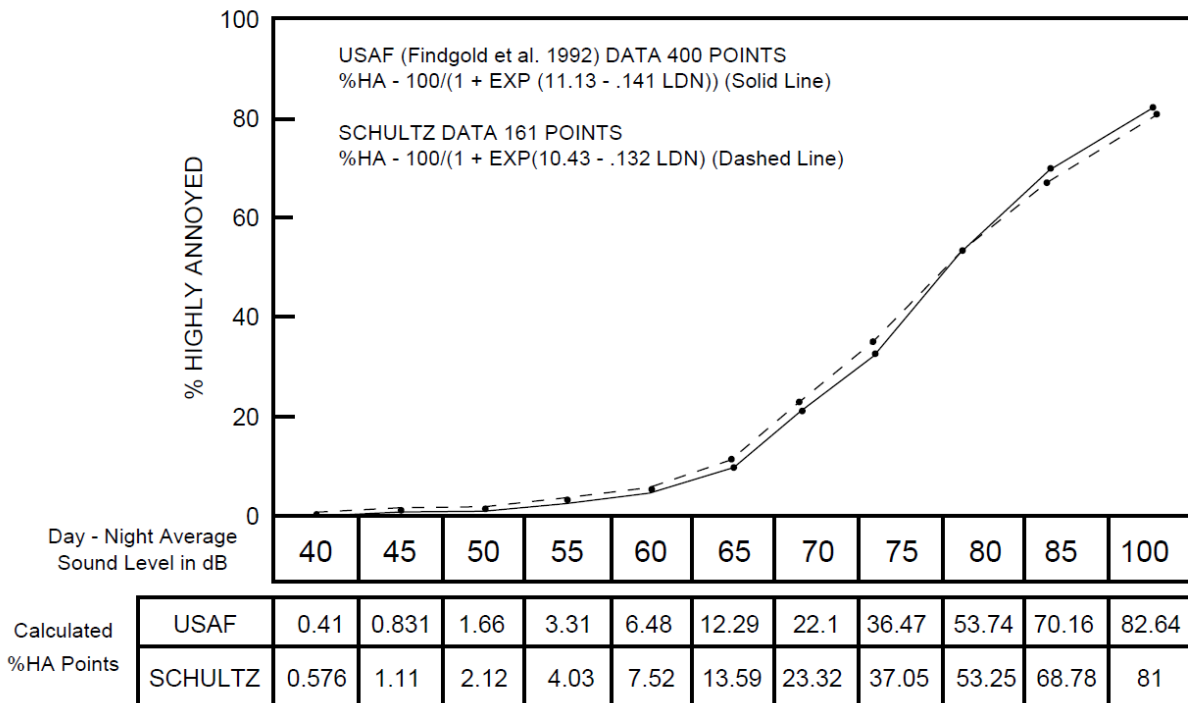

Figure 3.75 Estimates of the percent of the population that would be highly annoyed based on DNL (Federal Interagency Committee on Noise, 1992).

The National Academy of Sciences and the FAA recently sponsored research into annoyance specifically related to helicopter noise. The investigation focused on seven hypotheses developed from the available research (Mestre et al., 2017):

1. Annoyance prevalence due to helicopter noise is more significant than that due to CTOL aircraft for the same noise levels.
2. The best metric to correlate to helicopter noise annoyance is the cumulative A-weighted exposure.
3. Helicopter impulsive noise is a driving factor of annoyance, so an adjustment to the cumulative A-weighted exposure would help to model annoyance.
4. The low-frequency noise content of helicopter noise induces secondary rattle in indoor locations, which contributes to annoyance.
5. Non-acoustic factors contribute significantly to annoyance due to perceived helicopter noise.
6. Community annoyance is as significantly associated with proximity to helicopter flight paths as the noise they generate.
7. Complaints lodged are a better indicator of annoyance than noise levels or proximity to a helicopter flight path.

Three distinct urban areas (Long Beach, CA; Las Vegas, NV; and Washington, D.C.) were surveyed for annoyance concerning annoyance due to helicopter operations. Regression analysis in this study determined that there was no support for helicopters being more annoying than CTOL aircraft, nor that BVI or secondary emissions like rattle contribute significantly to annoyance. Some evidence

suggested that A-weighted cumulative exposure was an indicator of annoyance, but only in one of the three sites; corrections to this criterion due to impulsiveness and low frequencies, as well as consideration of different weightings, did not improve it as a metric. The authors note that strong evidence of non-acoustic metrics of annoyance was likely and that proximity to flight tracks was a “good predictor of self-reported annoyance” (Mestre et al., 2017). This seems to indicate that for low numbers of additional aircraft, as will likely be seen at the introduction of UAM vehicles, there is likely to not be significantly more annoyance. However, as the number of daily trips increases, there will likely be an increase in annoyance, even if the cumulative noise exposure in an area increases only marginally. Additionally, it will likely be important to assess the DNL impact UAM vehicles have on communities, even if they are significantly quieter than existing aircraft.

The World Health Organization (2018) recommends DENL of 45 dB or lower and NL of 40 dB or lower for aircraft noise, as higher values are tied to adverse health effects.

The FAA conducted a combined mail and telephone noise survey in communities close to 20 different airports throughout the country that had at least 100 average daily jet operations, subjected more than 100 persons to DNL greater than or equal to 65 dB, and subjected at least 100 persons to a DNL between 60 dB and 65 dB (Miller et al., 2021). This most recent study found significant annoyance at a much lower level, indicating that 65.7% of the population is highly annoyed with the same 65 dB DNL. As with all of the aggregated surveys, individual communities show large differences, with some communities responding with about 40 percent highly annoyed at the DNL of 65 dB, while others responded with nearly 80 percent highly annoyed. However, even at the lowest of the community responses, there is still an apparent 30 percent increase in respondents who are highly annoyed when compared to the 1992 study.

McKinsey & Company performed a societal acceptance study of UAM vehicles in Europe for EASA, which investigated a wide range of concerns, including safety, environmental and noise, and security (European Union Aviation Safety Agency, 2021d). Where noise was concerned, the study conducted a small pilot investigation in a lab setting. Twenty participants were exposed to 80 dB<sub>max</sub> sounds from standard transportation sources, including a bus, motorbike, jet aircraft, and helicopters, in addition to sounds from small and large drones and an air taxi. While the maximum noise level was held constant, the duration and character of each sound were not adjusted, so metrics such as the SEL or EPNL were not held constant for each source. Asked to rank the annoyance of each sound on a 0 (not annoyed at all) to 10 (extremely annoyed) scale, the participants’ responses were aggregated. On average, aircraft of all types were ranked more annoying than ground transportation, with UAM vehicles and large drones being ranked slightly more annoying than jet aircraft and helicopters.

#### **3.2.4.2 Current Noise Regulations**

The primary concern of noise regulation in this study is understanding what recommendations can be made regarding existing requirements as they pertain to UAM vehicles. To that end, the existing certification requirements must be understood. Therefore, while this report is not intended as an exhaustive report of the nuances of 14 CFR Part 36 (subsequently referred to as Part 36), the team presents in the following sections what we believe to be the most important aspects of current requirements as they pertain to UAM aircraft. For details on certification procedures as prescribed by current regulations and their implementation, readers are referred to the following primary sources:

- 14 CFR Part 36 (Federal Aviation Administration, 2011)
- FAA AC 36-4D (Federal Aviation Administration, 2017a)
- International Civil Aviation Organization (ICAO) Annex 16 Vol. I (International Civil Aviation Organization, 2017)
- ICAO Environmental Technical Manual Volume I: Procedures for the Noise Certification of Aircraft (International Civil Aviation Organization Committee on Aviation Environmental Protection, 2012)

Assessment of Part 36 regulations is constrained to sections pertinent to the majority of UAM architectures, though with the broad definitions of the category, it is likely some vehicles will have design aspects that fall outside the following discussions. Primarily, Part 36 Appendices G, H, J, and K will be assessed. Appendix G concerns propeller-driven small aircraft. While most UAM definitions exclude CTOL aircraft, this appendix is reviewed due to the aircraft size range and propulsion method to which it pertains and the potential applicability to vehicles able to fly both VTOL and CTOL mission profiles. Appendix H specifies the requirements for helicopters of all sizes and is significant as it concerns VTOL aircraft. Appendix J provides an alternative certification procedure for light helicopters, which are closer in size and weight to most UAM vehicles contained in the database (Section 3.1). Appendix K addresses tiltrotor aircraft, which many UAM vehicles closely resemble.

Additionally, Part 36 Appendix A is discussed as applicable to the designs, but best practices in terms of atmospheric conditions and acoustic measurement techniques beyond aspects unique to aircraft testing are not discussed in this review of certification requirements and procedures. Part 36 appendices B and F are omitted from this review. Appendix B applies to designs that are considered too dissimilar to UAM aircraft to be readily applicable, and appendix F is omitted as it is no longer applicable to new designs.

#### 3.2.4.2.1 Fixed-Wing Aircraft

Appendix G to Part 36 applies to propeller-driven, fixed-wing aircraft with a MTOW at or below 19,000 lb (8,618 kg). For size reference, a Beechcraft King Air 350ER, which can carry up to 11 passengers and a maximum range of 2,539 nm (4,702 km), has a MTOW of 16,500 lb (7,484 kg) (*King Air 360ER*; Peacock, 2020). There is no specification for aircraft engine type (e.g., piston, turbine, or electric motor), though several sections of the appendix implicitly assume internal combustion.

Certification noise measurements are gathered for a minimum of six flights over a prescribed takeoff flight path, defined in two phases. The first phase begins with brake release with the aircraft under takeoff power to the point where it achieves a height of 50 ft (15m) above the runway. During the second phase, the aircraft is to climb at the best rate of climb ( $V_y$ ) with the airplane in the climb configuration using takeoff power throughout (or as long as possible under airworthiness limitations). A single, inverted microphone makes noise measurements mounted over a ground plane 8,200 ft (2,500 m) downrange of the start of the takeoff roll. Aircraft must pass over the microphone within a corridor laterally  $\pm 10^\circ$  from vertical and  $\pm 20\%$  of the reference altitude. The reference altitude for Appendix G aircraft depends on aircraft performance and is not prescribed as a constant altitude as it is for flyover and approach tests for helicopters and tiltrotors. As a result, there is variation in the distance between the aircraft and the microphone. Figure 3.76 shows the reference

flight path. As specified by the FAA, the actual flight path used is not required to include a complete takeoff, but is allowed to intercept the reference flight path at 20 percent of the reference height (Federal Aviation Administration, 2017a).

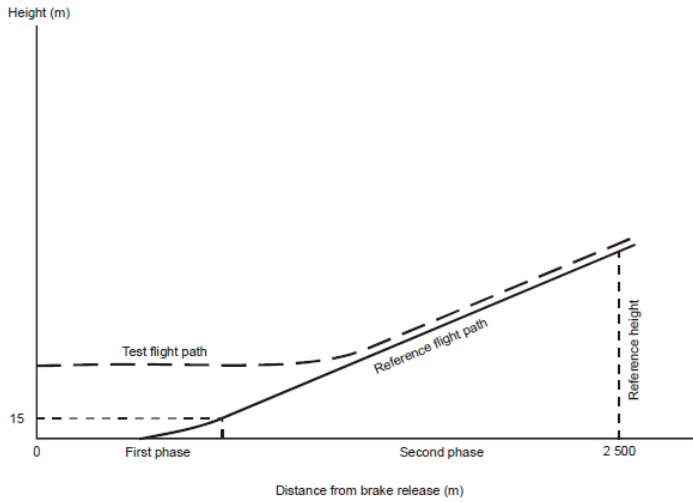

Figure 3.76 Noise certification flight path for light, propeller-driven aircraft (Federal Aviation Administration, 2017a).

Noise limits for this category of aircraft are prescribed in the maximum A-weighted sound level,  $L_{Amax}$ . This limit is based directly off the A-weighted sound levels measured during the test, corrected for flight and atmospheric conditions. Limits for individual aircraft are based on the MTOW and whether it is a single- or multi-engine aircraft. Noise limits for airplanes under Part 36 Appendix G are shown in Figure 3.77.

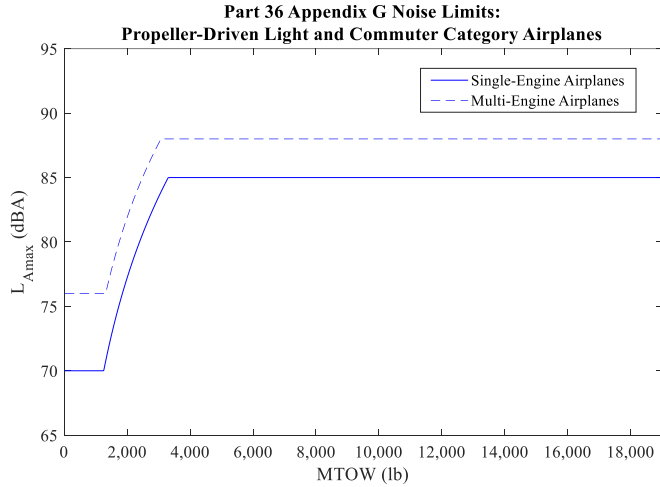

Figure 3.77 Part 36 Appendix G noise limits for propeller-driven light and commuter category airplanes with a MTOW of no more than 19,000 lb (8,168 kg) (Federal Aviation Administration, 2011).

#### 3.2.4.2.2 Rotary-Wing Aircraft

Appendix H provides the noise certification requirements for helicopters. These procedures must be followed for rotorcraft with a MTOW greater than 7,000 lb (3,175 kg) but can be applied to any size rotorcraft. Two civilian helicopters that would be governed by Appendix H requirements (assuming both are certified through the FAA) are presented hereafter for size reference. The Bell 525 is under development and is planned for up to 20 passengers with a MTOW of 20,500 lb (9,299 kg) (*Bell 525 Fact Sheet*, 2019). On the lower end of the MTOW required to certify under these procedures is the Airbus Helicopters H145, which has room for up to 10 passengers, a range of up to 351 nm (650 km), and a MTOW of 8,378 lb (3,800 kg) (*H145 Technical Information*; Peacock, 2020). The H145 has a higher MTOW, a larger number of passengers, and over double the range of any vehicle in the Top 10+ UAM Database (Section 3.1.2). The differences in size, weight, and mission profile for these vehicles make the direct application of this appendix to UAM vehicles challenging.

Three separate test conditions must be performed for certification: takeoff, flyover, and approach. At least six flights must be performed for each separate test condition. Three microphones are placed within the testing region for each of these conditions, each mounted at 4 ft (1.2 m) above the ground on a tripod. One microphone is located along the center of the flightpath, directly under the helicopter. The other two microphones are located 492 ft (150 m) on either side of the flight path. The lateral microphones measure the noise radiated to either side of the vehicle due to the directional nature of helicopter noise. The three test conditions and the microphone layout are shown in Figure 3.78.

The flightpath of the takeoff certification test begins at 65 ft (20 m) above the ground, 1,640 ft (500 m) upstream of the microphones. From that point, the helicopter must climb at a constant angle corresponding to its best rate of climb at the aircraft-rated speed for that climb,  $V_y$ . Each flight must continue along this path until the noise measured from the helicopter is continuously at least 10 dB quieter than the maximum Tone Corrected Perceived Noise Level (PNLTM). Similar to the takeoff procedure described in Appendix G, the distance between the microphones and the aircraft during the flight path depends on the vehicle's performance characteristics, not a specified altitude.

The flyover condition for helicopters is performed at an altitude of 492 ft (150 m) at an airspeed corresponding to the lowest of:

- $0.9V_H$
- $0.9V_{NE}$
- $0.45V_H + 65 \text{ kts}$  ( $0.45V_H + 120\text{km/h}$ )
- $0.45V_{NE} + 65\text{kts}$  ( $0.45V_{NE} + 120 \text{ km/h}$ )

where  $V_H$  is the airspeed in level flight obtained using the minimum specified engine torque corresponding to maximum continuous power at the maximum certificated weight, and  $V_{NE}$  is the never-exceed airspeed of the aircraft. The straight and level path is continued to the point where the noise is at least 10 dB quieter than the PNLTM for all three microphones. The approach condition is the final condition for the certification testing of helicopters. The helicopter descent angle is prescribed a  $-6^\circ$ , passing directly over the middle microphone at an altitude of 394 ft (120 m). This constant descent-angle flightpath begins far enough upstream of the microphones and extends downrange far enough that the test captures all noise within 10 dB of the PNLTM measured by each microphone. It is generally believed that the  $-6^\circ$  approach angle results in the worst-case noise due

to BVI noise. However, there is some evidence that this may not be universally true, and procedures from ICAO offer a suggested alternative procedure for governing authorities to include a  $-3^\circ$ ,  $-6^\circ$ , and  $-9^\circ$  flightpath angle and using the arithmetical average of these cases for the approach noise measurement (International Civil Aviation Organization, 2017).

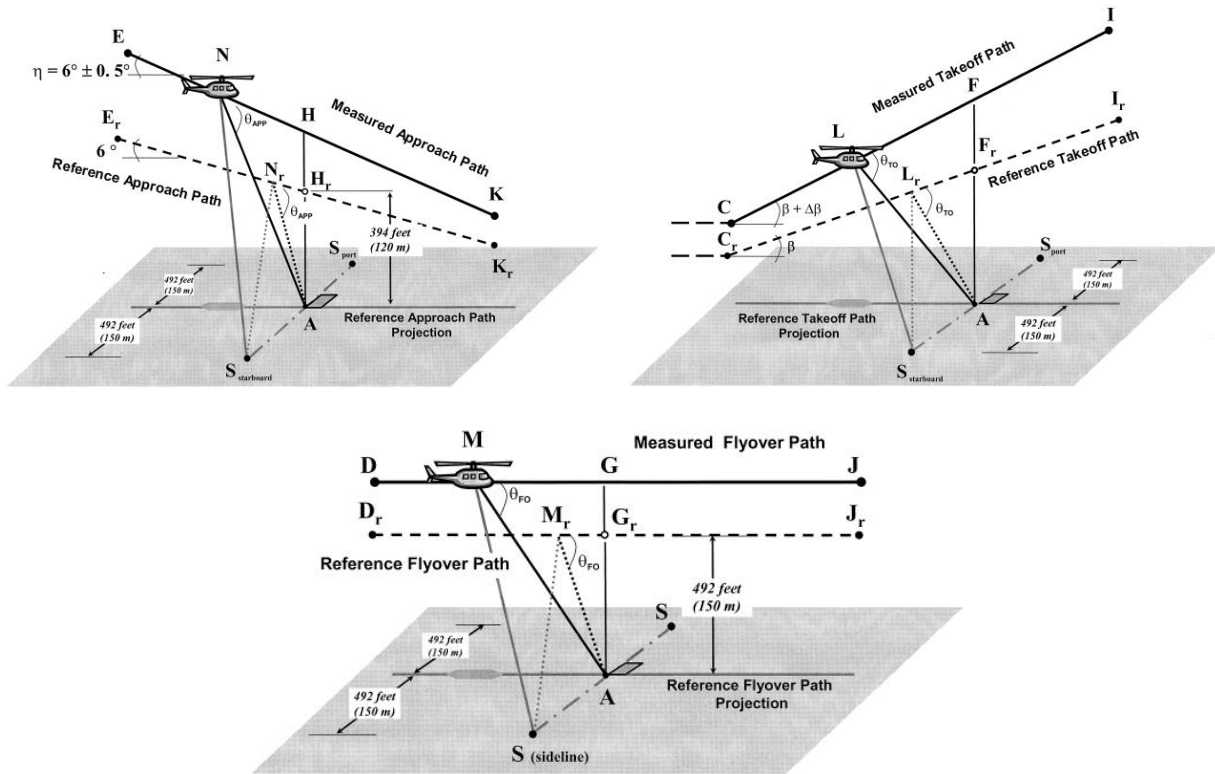

Figure 3.78 Part 36 test conditions for helicopters. Reproduced from (Federal Aviation Administration, 2011).

Noise requirements for helicopters are specified in EPNL. This metric accounts for the duration and tonal components of the noise event to equate the measured sound levels to a perception of loudness for human hearing (Bennett & Pearsons, 1981). The EPNL is a summation of the PNLTM at each half-second interval over the entire duration of the test that is within 10 dB of the maximum PNLTM. Detailed calculation procedures for EPNL can be found in several sources (Bennett & Pearsons, 1981; Federal Aviation Administration, 2011; International Civil Aviation Organization, 2017). Noise requirements for Stage 3 helicopters are shown in Figure 3.79.

These procedures provide the general framework for the certification procedures for tilt-rotors in Appendix K. Additionally, a simplified version of these procedures was adopted for light helicopters in Appendix J.

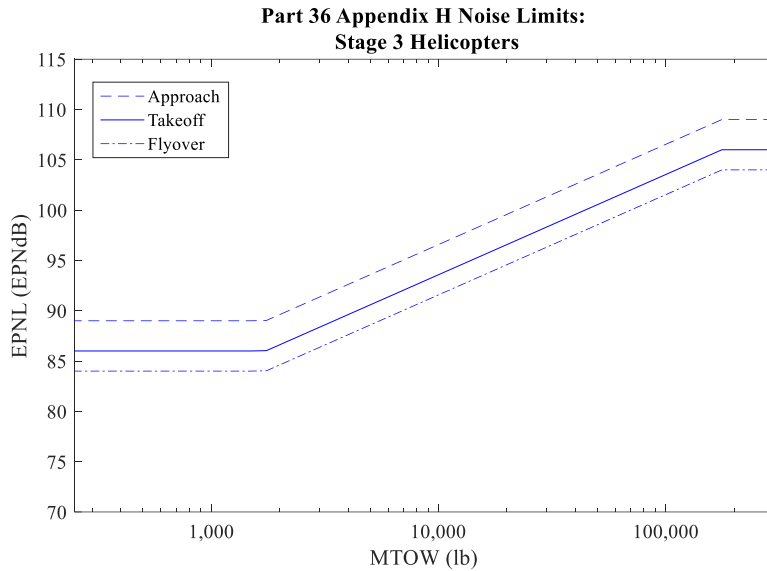

Figure 3.79 Part 36 Appendix H noise limits for Stage 3 helicopters (Federal Aviation Administration, 2011).

Appendix J provides an alternative certification method made available to light helicopters with a MTOW of 7,000 lb (3,175 kg) or less. This alternative method simplifies the test procedures and analysis required for certification. Helicopters that fail to certify under Appendix J can be certified under Appendix H. Two light helicopters that are within the MTOW limits of Appendix G are the Bell 429 Global Ranger and the AugustaWestland AW109S Grand. Both of these helicopters have a MTOW of 7,000 lb (3,175 kg) and carry 7 passengers and 1 crew member. The Global Ranger has a range of 390 nm (720 km), while the AW109S Grand has a range of 464 nm (859 km) (Peacock, 2020). It is unknown whether these helicopters are certified under Appendix H or J (or equivalent foreign procedures). These helicopters are presented to help the reader understand the weight of aircraft that might fall within this category. Both these rotorcraft have a greater passenger capacity and longer range than any of the vehicles in the UAM Top 10+ database.

The simplified certification process for light helicopters reduces the required flight procedures from three (takeoff, flyover, and approach) to a single flyover condition, with the same six-flight minimum. The reference flyover path is performed at the same altitude as those in Appendix H, 492 ft (150 m), at the minimum of four-speed options near the maximum speed of the helicopter. Throughout the measurement region, the helicopter is expected to maintain maximum normal operating RPM. The measurement region includes the entire flightpath region where the A-weighted sound level is within 10 dB of the maximum value recorded. If the helicopter sound level doesn't exceed the background sound level by at least 15 dBA, a lower altitude may be used to conduct the certification flights, with the measured sound levels corrected to the reference measurement altitude.

A single microphone located directly under the reference flight path is utilized for these certifications. It is mounted 4 ft (1.2 m) above the ground using a tripod, as specified in Appendix H helicopter noise certification testing. The lateral microphones are omitted. The noise measured by this single microphone is converted into SEL, which is a measurement of the energy measured over a noise event averaged into a one-second reference interval (Bennett & Pearsons, 1981). This metric



accounts for the duration of a sound event but not for tonal impact as EPNL does. Data corrections are applied for differences from reference flight path for aircraft altitude and airspeed. Noise limits for light helicopters certified under Appendix J are shown in Figure 3.80.

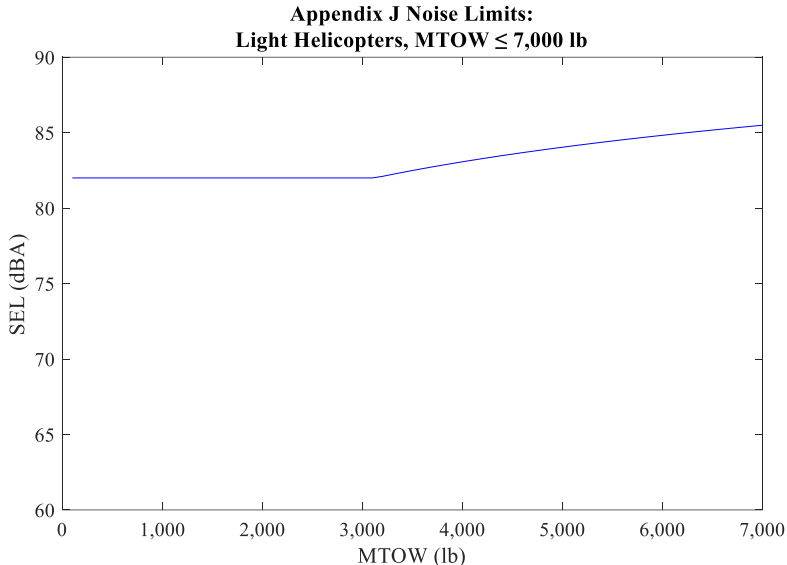

Figure 3.80 Appendix J noise limits for light helicopters with a MTOW of no more than 7,000 lb (3,125 kg) (Federal Aviation Administration, 2011).

Appendix K provides the noise certification requirements for tiltrotors. These procedures are generally the same as those for helicopters in Appendix H, with only minor differences. These procedures were substantially developed based on the Bell XV-15 tiltrotor (shown in hover in Figure 3.81), which is a 9-passenger aircraft with a MTOW of 15,000 lb (6,804 kg) and a maximum range of 445 nm (824 km) (Tilt Rotor Project, 1975). Similarly, sized tilt wings are currently in development, but no significantly smaller airframes have been certified. The UAM market has several upcoming designs broadly similar to tiltrotors, but with additional rotors that are significantly smaller and lighter.



Figure 3.81 Bell XV-15 tiltrotor in hover (NASA, 1980).

Takeoff, flyover, and approach procedures for tiltrotors are the same as for helicopters, with added specifications addressing the added degrees of freedom in the tiltrotor architecture. For the takeoff procedure, the nacelle angle must be inclined close to vertical. Additionally, the maneuver speed must be at the lower of either the best rate of climb speed or the lowest approved speed for climb after takeoff. For the flyover procedure, the nacelle must be in the orientation closest to that for which it is certified for zero airspeed. This orientation directs the thrust downward, replicating a helicopter configuration, which is typically louder than a fixed-wing aircraft. The maneuver speed specified is 90% of the maximum authorized speed for that nacelle angle ( $0.9 V_{CON}$ ). The approach condition requires the nacelles to be at an angle for which the best rate of climb or the lowest approved airspeed for approach can be achieved while still following a  $6^\circ$  approach path.

Tiltrotors are certified using the EPNL metric using the same three-microphone setup as Appendix H for helicopters. Noise limits are slightly higher than those found in Appendix H and are shown in Figure 3.82.

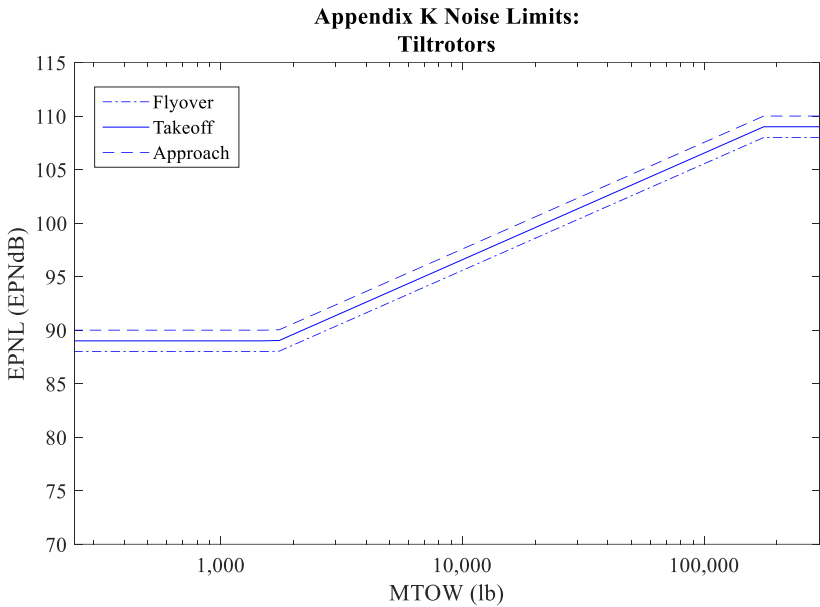

Figure 3.82 Appendix K noise limits for tiltrotors (Federal Aviation Administration, 2011).

**3.2.4.3 UAM Noise Characteristics**

*3.2.4.3.1 Similarities and Differences to Rotary-Wing Aircraft*

UAM vehicles are often compared to existing rotary-wing aircraft when discussing certification, capabilities, and challenges. These comparisons can often inform preliminary decisions and provide a solid framework to develop an understanding of this new area. However, it is imperative that comparisons highlight the significant differences between these new aircraft and traditional rotorcraft.

The obvious first comparison often made is the application of vertical takeoff and landing. Both UAM vehicles and rotorcraft have the main propulsion directed downward during the takeoff and landing phases. Noise measured on the ground is louder due to the downward thrust vector, as evidenced by tiltrotor aircraft (Conner et al., 2000). Similar to rotorcraft, the distributed propulsion

of UAM vehicles increases the number of degrees of freedom of the system. This increase in complexity results in additional ways to perform the same flight operation. Beyond the terminal areas, those UAM vehicles with a lift + cruise or vectored thrust configuration would differ from traditional rotorcraft operations during other flight segments, aligning their operations more closely with tiltrotors.

The noise generated by UAM vehicles will be different in character from traditional rotorcraft because most will be equipped with DEP. Where helicopters concentrate their propulsion into one or two large, primary rotors, DEP uses multiple, smaller rotors to produce the required thrust and maneuver the vehicle. While helicopters utilize cyclic and collective pitch control to maneuver while operating at a constant RPM, vehicles with DEP primarily use fixed-pitch rotors and control the vehicle by varying the rotation rate of combinations of rotors. This is known as RPM-control and is commonly employed for small, unmanned multicopters.

For a single rotor, noise impulses occur with frequencies related to the BPF. Therefore, the noise signature contains evenly spaced peaks for a constant RPM. In the case of multiple rotors, which are constantly changing RPM, the consistency of the noise signals disappears, and peak pulses become arbitrary. In addition, the smaller rotors used for DEP decrease the blade tip speed. This reduction in tip speed reduces the high-speed impulsive noise that is often characteristic of rotorcraft. When high-speed impulsive noise is not present, broadband noise is a major contributor to the overall noise signature (Hayden & Aravamudan, 1978).

While many UAM vehicles will be strictly electric, some may employ hybrid-electric propulsion, using an internal combustion engine to recharge batteries in flight or provide additional power during periods of high demand. These vehicles would contain noise sources from both electric motors and traditional combustion engines.

#### *3.2.4.3.2 Electric vs. Internal Combustion Propulsion Noise*

One of the main differences between the propulsion planned to be utilized by most UAM vehicles and those in use with most conventional aircraft is the use of electric propulsion. This new application of electric motors has been considered a critical component to satisfying noise targets set by many UAM companies (Uber Elevate, 2016). The differences between electric motors and various forms of internal combustion engines are significant in many ways.

Aircraft reciprocating internal combustion engines produce significant noise related to the cylinder detonation frequency as well as at several harmonics above that frequency (Gasaway, 1969; Hallez et al., 2018). This noise is emitted primarily from the exhaust of the aircraft but can also be measured emanating from the intake manifold regions as well. The frequency of the engine noise is typically similar to that of the BPF for the rotor or propeller of the aircraft. Aircraft with these engines also tend to generate a significant amount of broadband noise that may be related to gearboxes, resonance noise, or other mechanical sources within the engine itself (Gasaway, 1969; Schildt et al., 2017).

Turbine engines (including turboprop and turboshaft) are also commonly used in aircraft due to their high power output and light weight. These engines produce less overall noise than a reciprocating engine but tend to produce higher frequency noise that is emitted more from the intake rather than the exhaust. The engine noise may be more noticeable due to the difference in frequency of the noise between the turbine engine and the BPF of the rotor or propeller (Gasaway, 1969).

In contrast to internal combustion engines, electric motors do not typically require the use of gearboxes or other complex mechanical linkages, which removes that noise source. Additionally, they do not produce the exhaust noise that results from the detonation within the engine. As a result, electric motors are typically quieter than comparable internal combustion engines. Higher frequency noise generated by electric motors has been shown to be mitigated in subscale testing with a duct around the fan and motor (Riley & Cuppoletti, 2021). The researchers suspected this could be achieved with a simple nacelle or other motor enclosure.

Flight testing was performed on an EXTRA 330LT, a fixed-wing, general aviation aircraft with a reciprocating engine, and an electric version, the EXTRA 330LE, to compare the noise signature of both vehicles (Hallez et al., 2018). Both aircraft performed a flyover at 50 ft and 1,000 ft above a microphone with similar flight conditions except for the propeller rotational speed. Measurements reveal that the electric version is significantly quieter, 6.7 dB at the 50ft flyover and 14.5 dB at the 1,000 ft flyover. Additionally, the sound quality changed with a decrease in roughness and tonality in the sound emissions from the electrically powered aircraft. The electric motor did produce sound with a higher degree of sharpness than the internal combustion engine. Similar flight tests were conducted using a Magnus Fusion 212 at two different airspeeds, 60 knots and 90 knots (Hallez et al., 2018). At the lower speed, the electrically powered aircraft was slightly quieter. At higher speeds, the noise reductions due to the electric propulsion were clearer, with reductions of 3.6 dB and 10.3 dB for the flyovers at 50 ft and 1,000 ft, respectively. These results show promise for decreasing aircraft noise emissions when electric propulsion is employed.

Hybrid-electric aircraft may have difficulties realizing the noise benefits of electric propulsion. Rizzi et al. (2020) noted that hybrid-electric UAM vehicles might utilize the internal combustion engine while on the ground to recharge batteries for flights. This would increase noise pollution around vertiports, which may be located in urban areas. Additionally, hybrid-electric vehicles may consider taking off and performing other maneuvers where large amounts of power are desired, with the internal combustion engine running. This would reduce the benefit of using electric motors to power the rotors, adding a secondary noise source from the internal combustion engine. Noise reductions in take-off and landing areas are essential to reduce overall noise pollution due to the likely proximity to populated areas. Therefore, if internal combustion engines are determined to increase noise pollution significantly, regulatory agencies may need to develop requirements for using combustion engines under certain flight maneuvers close to or on the ground.

Table 3.14 provides a summary of the key similarities and differences between traditional rotorcraft and UAM vehicles presented in sections 3.2.4.3.1 and 3.2.4.3.2. This summary is not intended to be an exhaustive list. Rather it summarizes the high-level comparisons available in the literature.

Table 3.14 Summary of similarities and differences of noise characteristics for traditional rotorcraft and UAM vehicles.

Criteria	Traditional Rotorcraft	Electric UAM	Hybrid UAM
<b>Takeoff/Landing</b>	VTOL	VTOL	VTOL
<b>Control Degrees of Freedom</b>	Few	Many	Many
<b>Power Source</b>	Piston engine or turbine	Electric motor	Electric motor + piston engine or turbine
<b>Number of Rotors</b>	$\leq 2$	$\geq 4$	$\geq 4$
<b>Primary Noise Frequencies</b>	Harmonics of BPF	Broadband noise	Broadband noise
<b>Primary Propulsion Noise Sources</b>	Rotor blade tip Engine exhaust (piston) Engine intake (turbine) Linkages/gearbox	Rotor blade tip Rotor interactions	Rotor blade tip Rotor interactions Engine exhaust (piston) Engine intake (turbine) Linkages/gearbox
<b>Engine Noise Frequency</b>	$\approx$ BPF (piston) Higher (turbine)	Higher (electric)	Higher (electric) + $\approx$ BPF (piston) Higher (turbine)
<b>Impulsive Noise</b>	Likely	Unlikely	Unlikely
<b>Noise Qualities</b>	+ Roughness + Tonality – Sharpness	– Roughness – Tonality + Sharpness	Unknown

3.2.4.3.3 *Effect of UAM Design Characteristics on Noise*

The complexity and integration of DEP into UAM vehicles may have a noticeable effect on the acoustics of the vehicles. The interactions between multiple rotors and between the airframe and rotors are not well understood, especially regarding acoustics. While some research is available for the acoustics of small-scale rotors and for the interaction of large-scale rotors in tandem and coaxial configurations, the acoustics of mid-size rotors applicable to UAM vehicles is still an active area of research.

Rotor spacing can play a significant role in rotor acoustics due to the interactions between the rotor flowfields. The separation distance between rotors, both in-plane and axially, plays a significant role. Additionally, tip orientations for the same rotor separation distance can significantly impact acoustic signatures.

Studies using small Unmanned Aerial Vehicle (UAV) rotors with diameters under one foot have shown increases in the Overall Sound Pressure Level (OASPL) of 3–5 dBA when rotors are placed within 0.05 diameters of each other compared to isolated rotors (Alvarez et al., 2020; Zhou et al., 2017). The majority of this increase in noise was seen when rotors were within 0.2 diameters. Rotors

that had a full diameter of separation exhibited little increase in noise generation. The increase in noise was shown to correlate well with an increase in thrust standard deviation in both lab experiments and numerical simulations. For the closest separation, 0.05 diameters, Alvarez et al. (Alvarez et al., 2020) showed that an axial offset of 0.5 diameters decreased the OASPL by about 4 dBA. These investigations demonstrated that the proximity of the rotors caused the blades of one rotor to pass through the wake regions of the other. This caused unsteady loading, which contributed to loading noise. For counter-rotating, coaxial rotors, the optimal separation was found to be slightly smaller, ranging between 0.2 and 0.4 diameters when using psychoacoustic measures (Torija et al., 2021). In all cases examined, the increase in sound was most significant above or below the plane of the rotors and least significant in-plane with the rotors.

When considering the impact of wind across the rotor disk, the trends identified during hover tests appear to be less definitive. For tandem rotors (i.e., rotors separated only in the streamwise direction with their rotor disks on the same plane), a separation distance of 0.3 diameters resulted in the lowest OASPL, with both closer and farther separations performing similarly worse (Celik et al., 2021). Generally, higher freestream speeds increased the noise measured, but this was not always the case.

To understand the effect of rotor-on-rotor interaction on possible rotor configurations for UAM vehicles, Smith et al. (2020) virtually tested single-rotor, quad-, hexa-, and octo-copter configurations with varied rotor phasing. Each one of these configurations was tested with neighboring rotors oriented orthogonally and tip-to-tip. The tip-to-tip phasing minimized the tip-to-tip spacing amongst neighboring propellers, while the orthogonal maximized the spacing. The noise signature was calculated by solving for the aerodynamic loads using a blade-element-momentum theory coupled with a finite-state dynamic wake model and the industry-recognized PSU-WOPWOP code to solve for the aeroacoustics. The aircraft's gross weight, blade root pitch and twist, total disk area, rotor solidity, blade taper, the blade's airfoils, and tip Mach number were kept constant across all configurations. The results from this investigation indicated that varying from orthogonal to tip-to-tip propeller phasing significantly affected the directivity of the sound and the peak sound levels. For the quadcopter with orthogonal phasing, noise reductions between 5-9 dB relative to the single rotor were visible. The total radiated acoustic power (PWL) appears to be comparable for the tip-to-tip and the orthogonal phasing cases for the quadcopter.

On the other hand, while the orthogonal phasing of the hexacopter and the octocopter showed reductions of up to 9.5 dB and 13-14 dB, respectively, and reduced PWL relative to the single rotor, the tip-to-tip phasing showed an increase in PWL. It was also found that increasing the number of rotors produced tonal peaks at higher frequencies. Since A-weighted sound measurements decrease the weighting of higher-frequency noise, existing certification methods may fail to capture these peaks and underestimate their impact on the listener.

In addition to rotor spacing, their position with respect to the airframe has been shown to impact the noise generated. Wang et al. (2019) investigated the aeroacoustic effect of supporting a small-scale rotor at 0.07 rotor diameters above or below a constant-diameter cylindrical airframe. The authors concluded that the rotor mounted below the airframe produced greater tonal and broadband noise across the whole frequency spectrum, which the authors attributed to the distorted inflow caused by the arm above the rotor. Additional noise was measured both in-plane with the rotor and below the rotor, with differing acoustic characteristics being amplified in each location. The proximity of the rotor to the airframe may have played a significant role in the increased noise generated. Zawodny

and Boyd (2017) investigated the effect of airframe shape and the separation between the rotor and support on the noise generated by small-scale rotors. The A-weighted OASPL measured below the rotor increased by 15 dBA for a rotor located 0.1 diameters above a constant-diameter airframe when compared to an isolated rotor. Rotors situated at least 0.4 diameters above the showed minimal impact from the airframe. In general, the broadband noise level was not affected, indicating that the increased noise was due to rotor-generated turbulence. The conical airframe also directed higher BPF noise in the plane of the rotor, while the constant diameter support did not.

The existing body of research highlights the sensitivity of noise emissions to DEP configurations. Evidence suggests that turbulence ingestion significantly contributes to increased noise, whether from interacting with the wake of other rotors or from the airframe. However, much of the existing research has been performed in static facilities without the influence of wind or vehicle motion, which could alter current trends. The sensitivity of DEP configuration could affect the optimal placement of sound recorders during testing and certification. It is unclear if the current microphone placements would capture the highest value of noise generated by the vehicle.

Since turbulence ingestion is a major cause of increased broadband noise, it is worth pointing out that UAM vehicles may operate in highly turbulent airspace due to the effect of large buildings. This airspace extends 2.5 to 3 times the height of the buildings (Roth, 2000). If this phenomenon is deemed to cause significant increases in the noise generation of UAM vehicles, regulatory agencies may want to consider establishing fly zones above this limit.

#### *3.2.4.3.4 Full-Scale UAM vehicle noise measurement data*

With the novelty of UAM configurations, few studies are publicly available on full-scale vehicle noise tests. While numerous tests have been conducted recently investigating rotor noise at the small-consumer UAV scale, most of these tests were conducted on stationary rotors without the influence of flight maneuvers (e.g., forward velocity), which could significantly impact acoustic behavior. Additionally, the impact of scaling on the results has not been demonstrated for multi-rotors. There is promise that scaling could be found for most configuration parameters based on evidence from the comparison of sub- and full-scale helicopter rotor acoustics (Kitaplioglu & Shinoda, 1985), but lower-limits on model scale may exist for similarity to be achieved (Shenoy et al., 1986).

Pennsylvania State University and Beta Technologies have begun full-scale, isolated rotor testing as well as free-flight acoustic characterization of Beta's ALIA-250 UAM (Greenwood, 2021). A picture of the flight testing is shown in Figure 3.83. The full-scale single-rotor acoustic tests demonstrated that at low RPMs, broadband noise is prominent; however, the noise and positional data for the complete vehicle have not yet been published. Along with other aspects of the research program, the measurements on the full-scale UAM will be exceedingly helpful for the community to understand better the real-world differences between unique UAM configurations and rotorcraft noise.



Figure 3.83 Picture of Beta ALIA-250 during acoustic flyover tests (Greenwood, 2021).

NASA and Moog Inc. produced the most comprehensive dataset encountered, which performed acoustic testing on the “SureFly,” a proof-of-concept electric multi-rotor vehicle (Huff et al., 2021). This vehicle multi-rotor vehicle, shown in Figure 3.84, had four pairs of coaxial rotors. Testing was conducted on the ground, with thrust values kept just under takeoff levels. The test's goal was to understand the needs for UAM sound measurement better. Noise measurements were taken using microphones placed directly ahead of the vehicle and at the left-45 degree angle on the ground at 25, 50, 100, and 200 ft from the vehicle. Figure 3.85 shows a diagram of the test setup. While important to gathering the effect of distance on the data, these microphones were placed at different sound propagation angles.

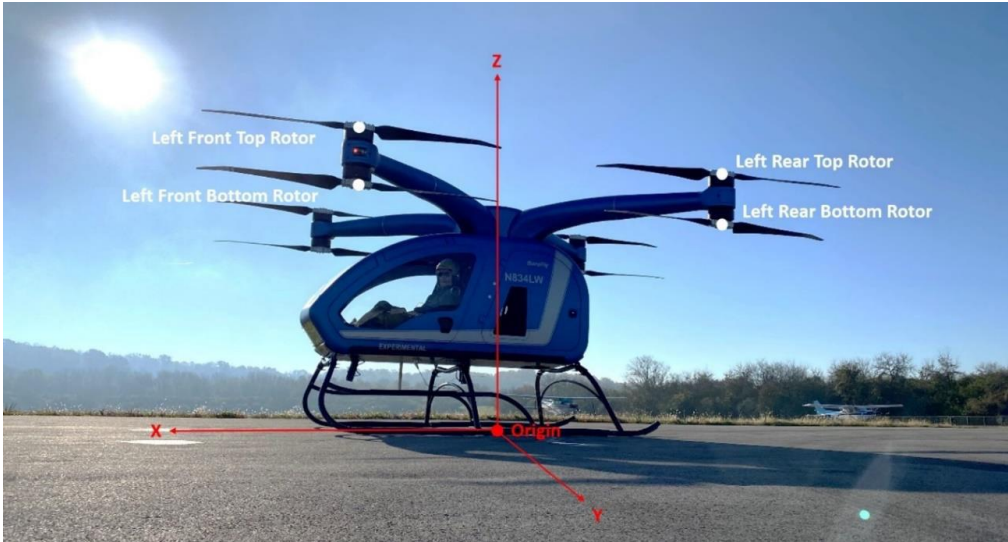

Figure 3.84 Moog “SureFly” proof-of-concept electric multi-rotor UAM (Huff et al., 2021).



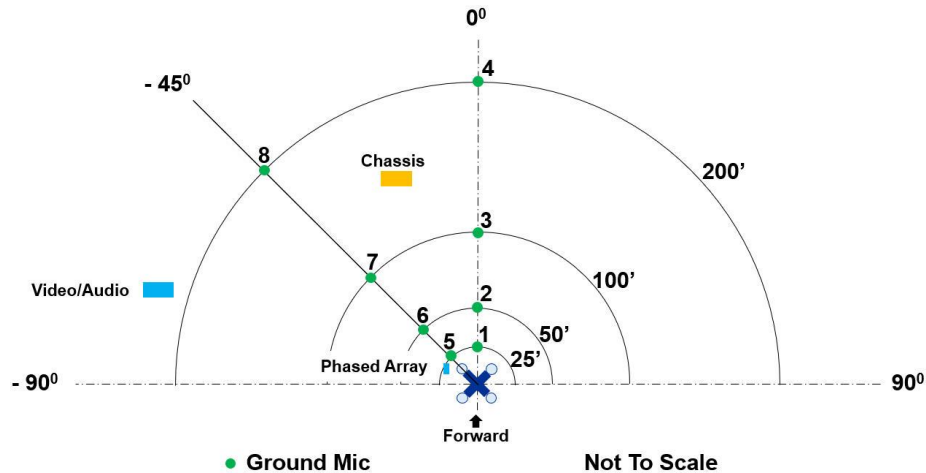

Figure 3.85 Microphone placement for testing performed on the Moog “SureFly” proof-of-concept vehicle (Huff et al., 2021).

As such, the comparison of noise measured at each distance was convoluted with a comparison between propagation angles. However, the study showed important results regarding the presence of low-frequency noise, which is typically filtered out by A-weighting and the selection of integration bands in the FAA certification requirements (Federal Aviation Administration, 2011). Due to the difference in the rotation rates of the upper and lower rotor on each arm, a fluctuation or beating at between 1.48 and 7.38 Hz was noticed with a magnitude of up to 6 dB. The lower rotor was found to be 6 to 10 dB louder than the upper rotor and at the 100 ft range, where the OASPL was around 77.4 dB (with all bands considered and no weighting); with A-weighting this OASPL decreased to 65 dB, indicating significant content outside the A-weighted bands. Noise frequency content increased with increasing throttle (rotor RPM), correlating to an increased BPF as expected. At lower rotor speeds, the ambient noise was very close to the measured noise spectra. This means that tests at these conditions would need to be performed in quiet areas or at a lower altitude than specified in the current regulations.

NASA and Joby Aviation recently completed acoustic testing on Joby’s full-size pre-production vehicle (Pascioni et al., 2022). The testing was performed at Joby’s flight base in Big Sur, California. NASA utilized its mobile acoustics facility that consists of 58 pressure omni-directional microphones arranged in a grid array. The acoustic test results for four types of flight conditions, including takeoff, landing, level flyover, and hover, were presented. A diagram of the flightpaths and locations of the individual microphones in the array is shown in Figure 3.86. The noise measurements in this article are presented in terms of A-weighted sound levels. According to the authors, sound levels using the SEL metric were calculated but not presented in the article.

The flight tests included 20 takeoff and landing flights. The flightpath angle varied for both these flight conditions from  $-5^{\circ}$  to  $3^{\circ}$ . For the landing condition, the acceleration ranged from  $-0.1$  g to  $0.05$  g. For the takeoff condition, the acceleration varied from  $-0.05$  g to  $0.2$  g. The selected accelerations and flightpath angles were representative of the likely operational conditions of the vehicle. The takeoff and landing flight testing results indicated that at a distance of 330 ft (100 m) from the flightpath (for a vehicle altitude up to 144 ft (44 m), the acoustic profile of the vehicle was

less than 65 dBA. The results also indicated that landing conditions exhibited higher noise levels compared to takeoff conditions.

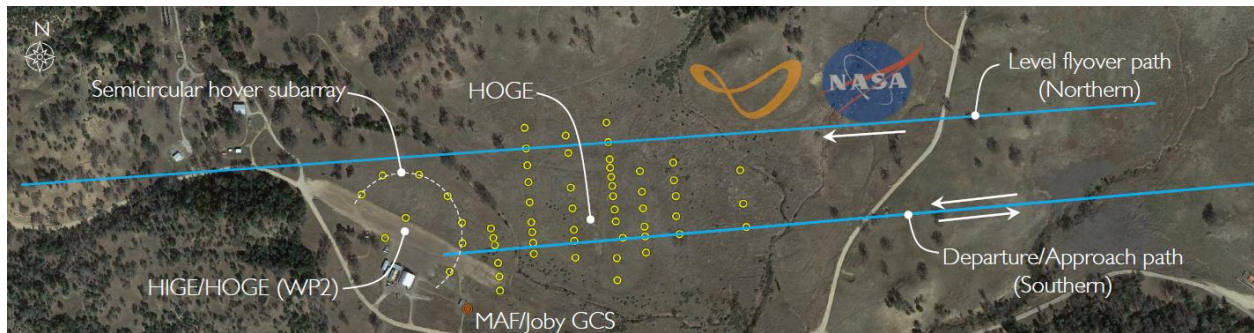

Figure 3.86 Acoustic array configuration and flightpaths used for NASA and Joby Aviation’s acoustic testing (Pascioni et al., 2022).

The level flyover tests were conducted at 350 ft AGL and constant airspeed. The true airspeeds varied from 50 kts to 100 kts. The lower altitude of 350 ft AGL was selected so that the vehicle noise profile was above the background ambient noise and, therefore, could be picked up by the ground microphones. Two types of level flyover conditions were tested: 1) full wing-borne conditions representing a high-speed cruise profile and 2) semi-thrust-borne modes representing a transition-like (between vertical and forward flight) profile. The level flyover flights were observed to be the quietest out of the complete matrix tested in this study. The full wing-borne modes were quieter than the semi-thrust-borne modes. The data from the microphones was processed using a NASA acoustics model to create a 100 ft radius hemisphere of the noise level below the vehicles. Utilizing the same model and applying standard noise correction methods, Joby calculated the acoustic noise level of the aircraft to be 45.2 dBA at 1640 ft (500 m) below the vehicle.

The hover tests were performed for two conditions: 1) in-ground-effect and 2) out-of-ground-effect. The altitude for the In-ground-effect tests was 6 ft AGL, and that for the out-of-ground-effect was 38 ft AGL. Trimmed conditions were maintained for 30 seconds during the flight testing, and 20 seconds of measured data was used for the noise level calculations. While the hover tests did not result in a worse noise profile when compared to the landing conditions, a large variation in the measurements of 2 to 5 dB was observed in a single run. The variation was even higher for back-to-back runs indicating difficulty in achieving a trimmed state with consistent rotor RPM settings.

The Joby flight tests were not intended to show compliance with Part 36 requirements. The flightpaths in their study differed significantly from the procedures laid out in the Part 36 Appendices H, J, and K applicable to rotary-wing aircraft. There were differences in the duration of data used in computing averaged noise levels, the number of microphones used, and the altitudes used in this study as compared to the Part 36 requirements.

#### 3.2.4.3.5 Implications of Existing Full-Scale UAM Vehicle Acoustics Research

There is limited full-scale data to fully describe the expected noise signatures from UAM vehicles, especially towards showing compliance with existing Part 36 requirements. However, the existing research appears to imply:

- DEP has the potential to significantly decrease the overall vehicle noise signature when compared to traditional rotorcraft.
- Low-altitude flightpaths are preferred for capturing the UAM vehicle noise signatures to distinguish the noise signature from the ambient noise.
- Carefully designed rotor configurations can decrease interactions between rotors, which would reduce the overall noise signature of a vehicle.
- The OASPL of electric propulsion can be quieter than equivalent internal combustion systems. However, the quality of the sound is different.
- The directionality of sound generated by DEP is likely to be different from rotorcraft, but the most significant increases in noise appear to be radiated below the rotor plane.
- A-weighting may not fully capture the frequency content of UAM vehicles. As a result, both higher and lower-frequency sounds are likely.
- Variations in rotor speeds can contribute significantly to the quality of the noise generated by UAM vehicles.

#### **3.2.4.4 Limitations of Current Noise Regulations in UAM Certification**

Two sets of considerations are important when addressing the limitations of current regulations concerning UAM certification. The first are those considerations that apply to these vehicles' fundamental ability to successfully complete the certification procedures as written. The other category concerns itself with whether the application of current certification procedures is appropriate for this new class of vehicles. The first category is reasonably small, but the latter is larger; some limitations contribute to both categories. Most of these limitations were presented in the recent white paper by the NASA UAM Noise Working Group (UNWG) (Rizzi et al., 2020). The limitations presented below have been synthesized from the UNWG paper, not attempting to address all aspects of UAM noise but focusing primarily on certification. The white paper was released in October 2020, and few of these considerations have had significant, publicly available information that can be used to draw meaningful conclusions. Where additional information is available, it is included here to discuss each of these limitations. However, many of the original points from the UNWG remain open.

##### *3.2.4.4.1 Applicability of Part 36 Appendix by UAM Configuration*

Upcoming UAM designs are more diverse than many certified aircraft have been, with the utilization of distributed propulsion and other mission-specific architectures that don't align directly with Part 36. It is fairly clear that CTOL UAM aircraft would align directly with Appendix G, and electric rotorcraft would align with Appendix H or J (depending on weight and ability to certify under the simplified procedures). As discussed below, some minor adjustments in certification methods may be needed for electric propulsion in these vehicles.

Wingless multicopters generally align with Appendix H and J. The fixed, predominantly vertical orientation of the rotors is representative of helicopters. The one consideration is the proximity of multiple rotors. While there is no provision that helicopters have only a single rotor, and there are notable helicopters that do operate with two laterally or longitudinally distributed rotors, there are no currently certified civil aircraft with 4, 8, or even 18 rotors as some UAM designs utilize. This large number of rotors and the utilization of RPM control will likely require some consideration in the appropriate appendices regarding vehicle operations during certification.

Vectored thrust UAM vehicles are most appropriately aligned with Appendix K. The behavior of these vehicles will likely be similar to existing tiltrotor vehicles. As with multicopters, considerations will likely be needed to address distributed propulsion and its direct relationship to the current regulations.

Lift + Cruise configurations are the most difficult to classify under the current regulations. Due to the nature of lifting surfaces on the aircraft and thrusters oriented to allow for VTOL or Short Take-Off and Landing (STOL) operations, it is most likely that these vehicles should be considered under Appendix K. However, because there is only a single orientation to the rotors, the independence of the forward propulsion could be neglected and allow for the classification of these vehicles under Appendix H or J. Since Appendix H and K have broadly similar procedures, classifying these vehicles as tiltrotors would provide the most straightforward certification, given the additional noise allowances for tiltrotors.

Notably, most vehicles in the UAM database (Section 3.1), especially those in the top 10 category, are light-weight, with MTOW under 7,000 lb (3,175 kg). While classification based on architecture may force these vehicles to certify under different procedures, the UAM market will primarily be dominated in the near term by these light-weight vehicles. Research during this project did not identify any experimental noise studies performed on tiltrotor vehicles with a MTOW under the maximum limit for Appendix J.

#### *3.2.4.4.2 Vehicle Degrees of Freedom*

Distributed propulsion included in the many UAM vehicles will create a certification challenge through the additional degrees-of-freedom in flight operations. These aircraft will likely have multiple control options for each maneuver, leading to difficulty in prescribing operating conditions for differing maneuvers. The “worst-case” conditions for noise generated by fixed- and rotary-wing aircraft are widely understood. These are the “dirty” configurations utilized under takeoff for CTOL aircraft and under takeoff, slow flyover, and approach conditions specified in Part 36 for rotorcraft. It is unclear what UAM configurations will result in the “worst-case” noise without additional testing (Rizzi et al., 2020). There is little publicly available data that establishes noise sensitivity to the selection of trim condition for varying maneuvers. The additional degrees-of-freedom make it impractical to test all configurations to establish operational parameters for every vehicle. Significant test campaigns and validated simulation tools will be necessary to establish requirements. The UNWG makes a strong point that whatever configurations are chosen, “Assurance is needed that typical procedures and control laws employed during testing and certification will not be vastly augmented later so as to realize some performance or cost-benefit at the expense of increased noise” (Rizzi et al., 2020).

#### *3.2.4.4.3 Flight Testing Under Trim Conditions*

Representative UAM sizing put forth by varying groups establish that these vehicles will be relatively light-weight (Rizzi et al., 2020). This generalization is supported by the vast majority of the vehicles included in the database discussed in Section 3.1. Lighter aircraft are more susceptible to atmospheric conditions, including ambient winds and gusts, which require more frequent adjustment to the distributed propulsion used in UAM designs (Rizzi et al., 2020). These variations could significantly impact the noise produced. For vehicles using RPM-control propulsion systems, peak noise may be increased due to wind loading. Moreover, the quality of the source noise may be changed by the variation in rotor rotational speeds between rotors.

The impact of using RPM-control for propulsion systems also creates the most significant challenge for certification under current regulations. Most of the designs presented in the UAM database utilize fixed-pitch rotors. This selection greatly simplifies the design of each system, with a significant cost and complexity reduction when considering the distributed propulsion systems in many UAM designs. All Part 36 appendices discussed here require stability of rotor speed within  $\pm 1\%$  of a specified RPM for the completion of at least one test procedure. For CTOL aircraft, certified under Part 36 Appendix G, there are alternative procedures provided for fixed-pitch propellers (§G36.111(c)(2)(iv)) with additional guidance provided in AC 36-4D (Federal Aviation Administration, 2017a) for methods to account for fixed-pitch propellers. This guidance is primarily concerned with the source noise generated by the aircraft to provide a correction method to account for off-condition engine RPM. Vehicles with multiple fixed-pitch rotors utilize RPM variations to stabilize themselves. These variations can easily exceed the  $\pm 1\%$  allowance defined in Part 36 (Bahr et al., 2020). With distributed propulsion designs for redundancy and safety, it is unlikely that all rotors would be operating at maximum RPM at any standard operational procedure.

As UAM vehicles use RPM-control to maneuver and stabilize the vehicle, the propeller phasing will be under constant change, affecting the directivity of the sound and the sound levels of the vehicle. For this reason, achieving repeatable measurements during noise testing and certification could be a challenge. The UNWG similarly noted that RPM control would “likely require more repetition of test conditions, tighter tolerances on aircraft control, more rigorous on-aircraft flight control instrumentation, and possibly longer data records than are currently typical” (Rizzi et al., 2020).

#### 3.2.4.4.4 *Flight Operations*

Due to the many potential vehicle configurations available, the operational procedures could vary widely from design to design. This is further confounded by the wide variety of possible locations for vertiports. Depending on configuration and site, some UAM vehicles may takeoff or land in a purely vertical flightpath, with a transition once a safe altitude has been achieved. Other situations may result in aircraft following a more moderate flightpath similar to current aircraft designs (Rizzi et al., 2020). These variations make it challenging to establish certification procedures that consider operations that are representative of actual operations.

Depending on operational requirements (or preferences) for varying designs, several additional maneuvers may need to be considered for certification (Rizzi et al., 2020):

- Transition from vertical flight to horizontal flight at low altitudes
- Extended hover operations at low altitude
- Continued motor operations while remaining at a vertiport for short times (this is a primary concern for small-area vertiports and community annoyance, which is beyond the scope of this report)

Sensitivity studies to varying operational states will be beneficial to help bin “worst-case” noise generation by operation and aircraft configuration. Depending on the findings of studies into vectored thrust, lift + cruise, and multirotor designs, there may need to be configuration-specific requirements in several more categories. Ideally, similar procedures would be found to be sufficient for all configurations, but there is insufficient data available to make this assessment yet.

#### 3.2.4.4.5 *Vehicle Performance Limitations (identified from the database)*

Most vehicles documented in the UAM database should be able to complete certification procedures as currently written. Still, a small minority have design limitations that would prevent them from completing certification testing as written. These vehicles are not within the Top-10 subset. The vehicles presented below are a selection of those that are unable to perform certification testing based on maximum altitude.

- The Frogs 282 is a wingless multicopter UAM designed as an automated air taxi designed for 2 passengers. This design has a cruise altitude of 100 m (328 ft), which is below both the flyover and approach altitude requirements for Appendix H. Based on weight, it would qualify for Appendix J certification, though the cruise altitude of the 282 would still be 50 m (164 ft) lower than the flyover certification criteria
- The Cartivator Skydrive is another wingless multicopter UAM designed for 2 passengers. It has a maximum design altitude of 50 m (164 ft).
- The Hover Formula is a lift + cruise configuration designed as an autonomous air taxi for 2 passengers. The maximum design altitude for the Formula is 150 m (492 ft), which allows performance of the flyover certification procedures under Part 36. However, if it is classified as a tiltrotor, it may be unable to adequately perform the approach flight condition. With a maximum altitude of only 492 ft, it would intercept the required flightpath approximately 930 ft (283 m) ahead of the microphone placement. Depending on the noise generated, this could be within 10 dB of the PNTLM.

Based on allowances made for light helicopters that do not generate at least 15 dB over ambient noise (Federal Aviation Administration, 2017a), it is reasonable that allowances could be made for lower altitude procedures for these vehicles. It would be reasonable to believe that several of these smaller vehicles with lower MTOW would require this adjustment, as is seen with the decrease in noise generated by UAV aircraft (Senzig & Marsan, 2018).

#### 3.2.4.4.6 *Operating Environment*

Currently, operating aircraft operate more commonly over less populated areas, with brief segments of flight operations located over cities. Rotorcraft tend to spend a larger percentage of their time over more densely populated areas than fixed-wing aircraft. Future UAM vehicles will be operating almost exclusively over densely populated areas. The change in environments between the generally open-space of current flight paths and urban canyons could be significant. Urban canyons will provide a more complex environment for sound propagation. Depending on the topology, these canyons could result in reflection, reverberation, and diffraction of aircraft noise, which could amplify noise measured in a primarily flat environment in certain areas (Rizzi et al., 2020). A vehicle certified using current Part 36 best practices could have a resultant noise signature that is significantly louder in certain areas due to this complex environment. The directivity of sound could also play a significant role. Current investigations focus on the noise radiated downward and, for some expansive test campaigns designed to model the hemispherical noise propagation from a helicopter, measurements are made up to the plane of the rotor (Greenwood, 2011); few vehicle flight tests investigate any sound radiated upward (Conner et al., 2006). In an urban environment, with UAM vehicles anticipating lower operating altitudes and a significant number of takeoffs and approaches, there is a possibility that upward noise propagation may need to be considered (Rizzi et al., 2020).

#### 3.2.4.4.7 *Noise Characteristics Differences*

Numerous sources contribute to the overall noise produced by an aircraft during flight. During different portions of flight operations, different noise sources will contribute most to the overall noise. Rotorcraft encounter significant BVI noise generated during approach as the rotor descends through its own wake. Current regulations require rotorcraft to certify under operating conditions likely to generate BVI noise. The large number of designs being developed for UAM vehicles could result in new noise prioritizations. Multiple independent electric motors, hybrid propulsion systems, rotor-airframe interactions, and rotor-rotor interactions are all potential new sources on top of traditional sources (Rizzi et al., 2020). Depending on the configuration, a UAM aircraft could have one, several, or all of these new noise prioritizations that need to be considered. Each of these could complicate the identification of the “worst-case” noise depending on the interplay between each of these sources and flight operations that emphasize each one.

The acoustic complexity of UAM propulsion systems will likely result in sound quality changes that alter the sound from the previously studied general patterns of fixed- and rotary-wing aircraft (including helicopters and tiltrotors). Distributed propulsion systems and RPM control could result in frequency, loudness, tonality, or several other noise characteristics not fully captured by current noise metrics (Rizzi et al., 2020). These noise differences are likely to be configuration and mission dependent and difficult to identify for all UAM vehicles with a single metric or testing procedure.

#### 3.2.4.4.8 *Vehicle Descent Angle*

Certification criteria, especially for rotorcraft, are intended to capture the worst-case noise generated by aircraft during standard operations (International Civil Aviation Organization, 2017; Rizzi et al., 2020). Empirical, numerical, and analytical work has been utilized to justify the establishment of procedures used for certification. However, there is some evidence that the conditions selected do not necessarily correspond to the worst-case noise for every vehicle. This evidence is primarily based on helicopter testing but highlights variations in approach angle and helicopter velocity that generate the worst-case noise.

Both Part 36 and ICAO standards call for a rotorcraft approach condition using a six-degree descent angle at the speed correlating to the vehicle’s best rate of climb,  $V_y$ . It is commonly believed that this is the angle at which the greatest BVI noise is generated. BVI noise is expected to be the dominant noise source, resulting in the worst-case noise for a rotorcraft vehicle (Federal Aviation Administration, 2017a). Little supporting documentation was located during this study to support the original selection of this condition.

During a pair of recent studies into noise abatement flight operations, NASA conducted significant flight testing of six light helicopters with a Takeoff Gross Weight (TOGW) under 4,500 lb (2,041 kg) and four medium-sized helicopters with TOGW between 7,400 lb and 14,200 lb (between 3,357 kg and 6,441 kg) (Pascioni et al., 2021; Watts et al., 2019). Each of these studies utilized large microphone arrays with at least 36 individual microphones to measure the noise generated by the helicopters during varying flight maneuvers. These procedures included flyover, takeoff, and approach conditions at several speeds and flightpath angles at values above and below those prescribed in Part 36. While the goal was to isolate noise abatement procedures, these studies provided a robust data set to assess whether certification procedures always correlate to the worst-case noise. The primary output data generated from these tests were 100 ft (30 m) noise source hemispheres for each helicopter, which can be utilized to predict ground noise via propagation. These

can also be compared to study the generated noise by the helicopters directly. Additional data were presented based on the maximum A-weighted sound pressure level measured by the microphone array for flyover, takeoff, and maneuvering flights.

Assessment of the hemispheres for these helicopters at velocities close to  $V_y$  indicated a likelihood that for two of the light helicopters and one of the medium-sized helicopters, a maximum sound level was achieved at an approach angle of six degrees. Two light and three medium-sized helicopters demonstrated a maximum Sound Pressure Level (SPL) at approach angles steeper than six degrees. One of the light helicopters indicated a maximum SPL at a shallower approach angle. The loudest approach angle was not clear for one of the light helicopters. The majority of the helicopters exhibited the loudest SPL within  $\pm 1.5^\circ$  of the Part 36 prescribed approach angle, but one light helicopter and one medium-sized helicopter produced the loudest SPL at approach angles at an angle at least three degrees steeper than prescribed in the certification requirements.

A similar assessment of the approach velocity during this test indicated that a similar spread of maximum SPL was found for the helicopters measured in this study, with the loudest conditions occurring in a spread around  $V_y$ . There were fewer tests performed at  $V_y$  in this campaign compared to data that correlated closely with an approach angle of six degrees, resulting in lower confidence in statements about approach speed and its correlation to the worst-case noise. It should be noted that these assessments were made using SPL, not EPNL. There is a possibility that the tonality, duration, or other weighting factors in the calculation of the perceived loudness could change the assessment of these comparisons. The evidence here suggests the possibility of off-certification conditions producing the loudest noise but is not an exhaustive nor conclusive result.

A similar test campaign was performed using the XV-15, a tiltrotor developed jointly by NASA, the U.S. Army, and Bell Helicopter Textron, Inc., with the goal of identifying noise reduction using flight operations. The five-year campaign was conducted in the mid-to-late 1990s in three phases that sought to use the additional degrees of freedom in tiltrotors to use and improve on the techniques developed for helicopters to avoid parts of the flight envelope that had relatively increased noise (Conner et al., 2000). Engineers on the program utilized varying approach angles, nacelle angles, and aircraft velocity and accelerations to generate noise profiles measured on large ground-based microphone arrays. Independent of the approach angle, the aircraft passed over a target area at 394 ft (120 m). These noise measurements were compared with Sound Exposure Level (SEL) and the average SEL value for all microphones in the array. This procedure identified that a  $9^\circ$  approach was about 2 dB louder than the standard  $6^\circ$  approach when the entire microphone array was averaged. The steeper approach also appeared to have peak SEL values equivalent to or slightly louder than the standard approach. These data are also compared, noting that the steeper approach angle had a shorter duration with closer proximity to the ground, so it likely generated a louder noise signature in that configuration compared to the standard approach. A shallow approach angle of  $3^\circ$  was quieter than the standard approach, and several composite approaches with multiple approach angles and nacelle angles also produced an average SEL value with significant benefits compared to the standard approach.

#### **3.2.4.5 Conclusions and Recommendations**

This study has identified several limitations in the procedures outlined in the current noise regulations. These limitations will need to be addressed to establish a generic set of certification



requirements and procedures applicable to a wide class of UAM vehicles. The limitations identified in this study are summarized below:

- Including all UAM architectures within the classification used in the current set of regulations is not possible. For example, Lift + Cruise UAM vehicles may not fit only in one type of classification.
- Current “worst-case” maneuver definitions may not apply to all UAM vehicles.
- There are currently no specified procedures for RPM-control vehicles (especially when it is difficult to achieve a trimmed state).
- No specified procedures exist for certain flight operations, including hover and transition, which may result in significant noise signatures for UAM vehicles.
- There are limited requirements defined for light vehicles. Regulations for tilt-rotor aircraft were developed for vehicles significantly heavier than expected UAM vehicles.
- Altitudes, flightpaths, and microphone distances specified in the current set of regulations may not adequately capture the noise signatures of UAM vehicles.
- Current noise metrics may not capture relevant noise signatures of UAM vehicles, which can cause annoyance.

The majority of the UAM vehicles rely on DEP. DEP results in a smaller rotor size that usually decreases the blade tip speed. This helps to reduce the high-speed impulsive noise signature making broadband noise a significant contributor to the overall noise signature. There is evidence from flight tests that electric propulsion can be significantly quieter (as much as 10 dB) at lower altitudes compared to internal combustion propulsion. These characteristics imply that most UAM vehicles may be considerably quieter than rotorcraft.

Most UAM vehicles have a MTOW under 7,000 lb, making them eligible to show compliance under Appendix J to Part 36, if they are classified as rotorcraft. The maximum noise limit specified in Appendix J is about 85 dBA SEL. Based on the acoustic test results on full-scale UAM vehicles reviewed in this study, most UAM vehicles should achieve an acoustic profile quieter than the Appendix J maximum noise limit. If lower noise limits are adopted in Part 36, for example, 62 dB  $L_{Amax}$  at 500 ft altitude as identified by Uber (Uber Elevate, 2016), certain UAM vehicles could face significant challenges in showing compliance to Part 36 requirements. Any changes to the noise limits in Part 36 appendices should consider community acceptance and fleet operations. Establishing recommendations for new noise limits for UAM vehicle certification was outside this study's scope.

Assuming that lower noise limits will be adopted in Part 36, the authors make the following high-level recommendations to amend the Part 36 procedures to enhance their applicability to UAM vehicles:

- Currently, the appendices in Part 36 include only the helicopter and tiltrotor configurations. These appendices should be amended, or additional appendices should be added that include requirements and procedures for various UAM configurations, including Lift + Cruise, vectored thrust, and wingless multicopter.
- Multiple numerical and experimental studies have confirmed that broadband noise significantly contributes to the overall noise signature of UAM vehicles. Since broadband noise can vary with vehicle architecture and operational conditions differences, defining a

single “worst-case” may not be possible. For example, Appendices H and K to Part 36 require the approach flightpath angle to be 6°. The appendices should include flight tests that cover a range of flightpath angles and speeds for the various UAM architectures.

- A lower flightpath altitude should be used for the certification tests to distinguish the vehicle's noise profile from the background ambient noise. Currently, the reference flightpath altitude for flyover tests is 492 ft (150 m) in Appendices H and K to Part 36.
- Additional flight conditions, including hover and transition, should be included in the appendices. These conditions might be critical if lower noise limits are adopted in the appendices. Additionally, the hover condition could face repeatability issues, as seen in the Joby Aviation acoustic tests (Pascioni et al., 2021). Appropriate tolerances in the noise limits should be established to account for such variability.

At present, due to the minimal dataset available on full-scale UAM vehicle acoustic tests, it is not possible to provide in-depth recommendations on the procedures outlined in Part 36 or derive appropriate MOCs specific to UAM vehicles.

The FAA is currently working with several UAM vehicle OEMs like Joby Aviation and Archer on developing a G-1 certification basis. This certification basis is based on the FAA’s Part 23 Amendment 64 with special conditions to address the unique UAM architecture features. This document is not available to the public. The noise regulations fall under the environmental consideration issue paper known as G-3. It is unknown whether the FAA or the UAM OEMs are currently addressing the G-3 requirements.

### **3.3 Task III – UAM Program Cost Estimation**

The advent of novel aircraft in the UAM market segment has raised numerous questions about the cost of certifying these new designs. Certification costs of conventional aircraft are better understood due to the significant historical data for most aircraft designs that companies and government agencies can use to estimate the potential costs. The novelty of UAM designs and the inexperience of many companies entering the field result in a big challenge when attempting to apply traditional cost estimation tools.

Numerous tools have been developed to provide rough budgetary estimates for project costs. These tools help companies and government agencies understand the capital risk before undertaking large projects. Each of these tools has been designed with a specific target application, and almost all have been developed using historical data. Applying these tools to novel designs and market segments does not guarantee valuable results. Assessment of these tools is important to understand whether or not they can be effectively applied to these novel designs.

In the current investigation, three cost estimation methods were assessed for their applicability to the certification costs of UAM aircraft. These models are the Development and Procurement Costs of Aircraft model IV (DAPCA IV), a modified version of the Eastlake model, and the NASA Advanced Missions Cost Model (AMCM). Due to the difficulty of isolating the actual expenditures required for certification, independent of the remainder of development, the total costs associated with developing a new design up to the first production vehicle were assumed to be included in certification costs unless the model provided an alternate definition. Each model is assessed below, along with a discussion on any modifications made to each model. In addition, the results from the Modified Eastlake model and AMCM are presented and compared briefly.

### 3.3.1 DAPCA IV

The DAPCA IV cost estimation model was developed by the RAND Corporation to estimate the cost of future military aircraft projects (Hess & Romanoff, 1987a, 1987b) and was a continuation of the previous DAPCA III program (Boren, 1976). This model is composed of Cost Estimation Relationships (CER), which are statistical equations relating project cost or effort to basic attributes of an item or project. These CERs are often developed using multi-variable least-squares regression analysis. The relationships in the DAPVA IV model were derived using the aircraft information from previously developed US military aircraft. The primary inputs in these equations are airframe weight, speed, production rate, and engine type.

This model was initially considered a strong candidate for assessing UAM certification costs. However, further analysis showed that the weight and speed of the aircraft used to generate the DAPCA IV model varied significantly from those of UAM vehicles. The aircraft characteristics for the vehicles used to develop the DAPCA IV model are summarized in Table 3.15. The airframe weight of the aircraft considered ranged from approximately 5,000–280,000 pounds, and the top speed of these vehicles was from 304–1,250 knots. Moreover, the slower the vehicle, the heavier the airframe (transport aircraft), while the lighter aircraft (fighters and trainers) had higher maximum speeds. The airframe weight and the cruise speed for vehicles in the UAM database are summarized in Table 3.16. Since detailed information is not publicly available, the airframe weight was estimated as 65% of the MTOW, as recommended by Gudmundsson (Gudmundsson, 2014). Note, while cruise speed is presented, this value is likely not significantly different from the vehicle's maximum speed as most commercial vehicles cruise close to their maximum speed. As shown, the values for cruise speed and airframe weight of UAM vehicles are significantly lower than those for the US military vehicles used in deriving the DAPCA IV model. Therefore, using the DAPCA IV cost model would require extrapolating the used data rather than interpolating it. Therefore, the investigating engineers deemed this model inappropriate to apply to UAM projects.

Table 3.15 Aircraft parameters used to develop the DAPCA IV model.

	<b>Airframe Unit Weight (lb)</b>	<b>Empty Weight (lb)</b>	<b>Wetted Area (sq. ft)</b>	<b>Maximum Speed (knots)</b>
Mean	32,257	47,815	5,091	734
Std. Dev.	52,769	63,306	6,475	320
Range	5,072 – 279,145	7,410 – 320,085	1,070 – 30,800	304 – 1,250+

Note. Data contained in the table obtained from *Aircraft Airframe Cost Estimating Relationships: All Mission Types*, Hess, R. W. and Romanoff, H. P., 1987. Copyright 1987 The RAND Corp.

Table 3.16 Estimated airframe weight and cruise speed for UAM database vehicles.

	UAM Database Top 10+ Subset		UAM Database Full	
	Est. Airframe Unit Weight (lb)	Cruise Speed (knots)	Est. Airframe Unit Weight (lb)	Cruise Speed (knots)
Mean	2,531	93	1,833	125
Std. Dev.	1,715	40	1,805	71
Range	515 – 4,550	43 – 156	6 – 8,947	27 – 410

### 3.3.2 Eastlake Model

The Eastlake Model is a highly modified version of the DAPCA IV model developed to estimate the cost of light GA aircraft, whose characteristics in terms of weight and speed are much closer to those of UAM vehicles (Gudmundsson, 2014). Similar to the DAPCA IV model, the main variables in the Eastlake model CERs are airframe weight, maximum speed, and production rate. Additional correction terms are included in the CERs to account for more complex design requirements and certification costs, including the use of composite materials, wings with taper, complex flap systems, cabin pressurization, and the certification type of the vehicle. The Eastlake model was studied further because its formulation utilized vehicles that were more closely related to UAM vehicles in terms of size and speed as compared to those used to develop the DAPCA IV model.

#### 3.3.2.1 Eastlake Model Outline

There are two methods in which the CERs are used to estimate costs within the Eastlake model. The first is an estimation of person-hours using the CERs described above. This method estimates the labor hours required for engineering, tooling, and manufacturing of the aircraft. The total cost for each area is estimated by multiplying the number of labor hours by the labor costs for each of these activities. The second procedure used is the direct use of CERs to estimate the costs of specific activities required to develop and manufacture an aircraft. These include the cost of development support, flight test operations, materials, and quality control. Additional cost estimates are included for propulsion, avionics, and landing gear. Each aspect of the model is briefly discussed below, including the mathematical formulation and activities considered. Detailed values for the correction factors in each CER can be found in Gudmundsson's (Gudmundsson, 2014) design text.

The Eastlake model estimates the cost to certify an aircraft as the summation of the engineering cost, tooling cost, development support cost, and the cost of flight test operations.

##### 3.3.2.1.1 Cost of Engineering

The engineering estimate includes all hours required for research, design, and for some testing and evaluation, though flight test costs are accounted for separately. The engineering hours,  $H_{ENG}$ , are estimated by:

$$H_{ENG} = 0.0396 \cdot W^{0.791} \cdot V^{1.526} \cdot N^{0.183} \cdot F_{CERT} \cdot F_{CF} \cdot F_{COMP} \cdot F_{PRESS}$$

where  $W$  is the weight of the airframe,  $V$  is the maximum speed of the aircraft,  $N$  is the production rate in terms of the number of aircraft estimated to be produced over a 5-year period. Additionally,

$F_{CERT}$  is the correction factor for certification type,  $F_{CF}$  for the presence of a complex flap,  $F_{COMP}$  for the fraction of structure using composite materials, and  $F_{PRESS}$  for a pressurized cabin. The cost of engineering is then:

$$C_{ENG} = H_{ENG} \cdot R_{ENG} \cdot CPI$$

where  $R_{ENG}$  is the rate of engineering labor, and inflation is accounted for using the ratio of the Consumer Price Index (CPI) between the desired year and the CPI in 2012, as presented by Gudmundsson (Gudmundsson, 2014).

### 3.3.2.1.2 Cost of Tooling

Tooling hours include those used to design and build tools, fixtures, jigs, and molds used to manufacture the aircraft. The total estimated number of tooling hours,  $H_{TOOL}$ , are estimated by:

$$H_{TOOL} = 1.0032 \cdot W^{0.764} \cdot V^{0.899} \cdot N^{0.178} \cdot Q^{0.066} \cdot F_{TAPER} \cdot F_{CF} \cdot F_{COMP} \cdot F_{PRESS}$$

Here  $Q$  is the estimated production rate in terms of aircraft per month, and  $F_{TAPER}$  is the correction factor for an aircraft with a tapered wing. The tooling cost is estimated the same way the engineering cost was, using the appropriate hours estimate and the labor rate.

### 3.3.2.1.3 Cost of Manufacturing

Manufacturing hours are those invested in building and assembling the aircraft directly. These hours are estimated as follows:

$$H_{MFG} = 9.6613 \cdot W^{0.74} \cdot V_H^{0.543} \cdot N^{0.524} \cdot F_{CERT} \cdot F_{CF} \cdot F_{COMP}$$

### 3.3.2.1.4 Cost of Development Support

Development support costs,  $C_{DEV}$ , include all overhead activities, including administration, facilities maintenance, human resources, etc., as shown below:

$$C_{DEV} = 0.06458 \cdot W^{0.873} \cdot V_H^{1.89} \cdot N_P^{0.346} \cdot F_{CERT} \cdot F_{CF} \cdot F_{COMP} \cdot F_{PRESS} \cdot CPI$$

Here  $N_P$  is the number of prototype aircraft manufactured during development.

### 3.3.2.1.5 Cost of Flight Test Operations

The estimate of flight test costs includes those associated with both development and certification flight-test programs.

$$C_{FTO} = 0.009646 \cdot W^{1.16} \cdot V_H^{1.3718} \cdot N_P^{1.281} \cdot F_{CERT} \cdot CPI$$

### 3.3.2.1.6 Cost of Materials

The total cost of raw materials used in the manufacture of tooling and of the aircraft is:

$$C_{MAT} = 24.896 \cdot W^{0.689} \cdot V_H^{0.624} \cdot N^{0.792} \cdot F_{CERT} \cdot F_{CF} \cdot F_{PRESS} \cdot CPI$$

### 3.3.2.1.7 Cost of Quality Control

Quality control costs include those of all technicians and equipment required to demonstrate each aircraft has been built to print. It is estimated as a fraction of the total manufacturing cost.

$$C_{QC} = 0.13 \cdot C_{MFG} \cdot F_{CERT} \cdot F_{COMP} \cdot CPI$$

### 3.3.2.1.8 Cost of Propulsion

The cost of the propulsion is also estimated separately using a choice of relationship depending on the type of propulsion. For internal combustion or turboprop engines, the engine cost is estimated by:

$$C_{PP} = R_{ICE} \cdot N_{PP} \cdot P_{HP} \cdot CPI$$

Where  $N_{PP}$  is the number of engines,  $P_{HP}$  is the rated brake- or shaft-horse power of the engine, and  $R_{ICE}$  is the estimated cost per horsepower.

The expense of fixed-pitch propellers is estimated at a fixed cost of \$3,145. Variable pitch propeller cost is estimated by a CER due to the increased complexity of the system. The variable-pitch propeller relationship is available in Gudmundsson's (Gudmundsson, 2014) design text but is not provided here as few UAM vehicles are anticipated to utilize variable-pitch propellers.

### 3.3.2.1.9 Additional Costs

The Eastlake model includes an estimated cost of \$15,000 for avionics for GA aircraft certified under Part 23. The equations above also include the cost of landing gear, but a discount of \$7,500 per aircraft is applied for fixed landing gear designs.

## 3.3.2.2 Modifications for Applicability to UAM Vehicles

Four primary modifications were made to the Eastlake model for application to UAM vehicles. These were introduced to account for platform differences with GA aircraft. These modifications included the addition of correction factors in the existing CERs, an extension of propulsion CER to account for electric motors, the addition of an estimate for battery cost, and an adjustment to propeller/rotor costs. These modifications are detailed throughout the following sections.

### 3.3.2.2.1 Additional Correction Factors

Additional correction factors were added to the Eastlake model to account for UAM vehicle characteristics not typically present in GA aircraft, such as tilting wings or rotors, autonomy, and electric or hybrid propulsion. Each of these parameters was believed to increase the cost of development and certification due to the additional complexity they added to the aircraft. The Hybrid-Electric factor,  $F_{HyE}$ , was introduced to account for the extra complexity of developing and manufacturing DEP systems that were either fully electric or hybrid-powered, and was initially proposed by Finger et al. (Finger et al., 2019). A tilting factor,  $F_{TILT}$ , was introduced to account for tilting rotors or a tilting wing, which would increase the complexity of the aircraft structures, flight controls, and flight test campaigns. The autonomy factor,  $F_{AV}$ , was introduced to account for the added redundancy, control system complexity, and computer system development required by a vehicle that could operate autonomously. The values for these factors are provided in Table 3.17. The values given to the hybrid electric factor were proposed by Finger et al. (Finger et al., 2019). The table's preliminary values for  $F_{TILT}$  and  $F_{AV}$  were based on the research team's engineering judgment, as no recommendations or data were available in the open literature. The values are only provided for the CERs in which they were introduced as a multiplier. For example, the modified equation for engineering hours is:

$$H_{ENG} = 0.0396 \cdot W^{0.791} \cdot V_H^{1.526} \cdot N^{0.183} \cdot F_{CERT} \cdot F_{CF} \cdot F_{COMP} \cdot F_{PRESS} \cdot F_{HyE} \cdot F_{TILT} \cdot F_{AV}$$

Table 3.17 Scaling factors added to the Eastlake model to account for design considerations unique to UAM vehicles when compared with GA aircraft.

CER	$F_{HyE}$		$F_{TILT}$		$F_{AV}$	
	ICE	Hybrid or Electric	Fixed Wing/Rotor	Tilt Wing/Rotor	Not Autonomous	Autonomous
Engineering Person-Hours	1	1.33 – 1.66	1	1.25 – 1.5	1	1.1 – 1.25
Tooling Person-Hours	1	1.1	1	1.1 – 1.25	-	-
Manufacturing Person-Hours	1	1.1	1	1.1	-	-
Development Support Cost	1	1.05	1	1.05	1	1.05
Cost of Flight Test Operations	1	1.5	1	1.5 – 2.0	1	2.0
Cost of Materials	1	1.05	1	1.05	-	-
Cost of Quality Control	1	1.5	1	1.1	1	1.1

The original Eastlake correction factors are summarized in Table 3.18. When assessing the model, the factors for certification, tapered wings, and complex flaps were thought to need modification depending on the vehicle being considered. No adjustments were made to these factors, as there was insufficient data to justify any changes. However, further studies on these parameters would be critical under a more directed application of this model. For the current study, it was assumed that all UAM vehicles would be certified under Part 23. Any wingless design used scaling factors of 1 for both  $F_{TAPER}$  and  $F_{CF}$ .

Table 3.18 Scaling factors for the Eastlake model.

CER	$F_{CERT}$		$F_{TAPER}$		$F_{CF}$		$F_{COMP}$		$F_{PRESS}$	
	LSA	Part 23	Const. Chord	Tapered Wing	Simple Flap	Complex Flap	0%	100%	Not Press.	Press.
Engineering Man Hours	0.67	1	-	-	1	1.03	1	2	1	1.03
Tooling Man Hours	-	-	0.95	1	1	1.02	1	2	1	1.01
Manufacturing Man Hours	0.75	1	-	-	1	1.01	1	1.25	-	-
Development Support Cost	0.5	1	-	-	1	1.01	1	1.5	1	1.03
Cost of Flight Test Operations	10	1	-	-	-	-	-	-	-	-
Cost of Materials	0.75	1	-	-	1	1.02	-	-	1	1.01
Cost of Quality Control	0.5	1	-	-	-	-	1	1.5	-	-

### 3.3.2.2.2 Electric Propulsion and Battery Cost

The engine cost equation was modified to include a term for the cost of the electric motors. The modified engine cost equation is:

$$C_{PP} = (R_{ICE} \cdot N_{PP} \cdot P_{HP} + R_{EM} \cdot N_{EM} \cdot P_{EM}) \cdot CPI$$

where  $R_{EM}$  is the dollar cost per kW of motor power,  $N_{EM}$  is the number of electric motors, and  $P_{EM}$  is the power of each electric motor. The internal combustion part of the equation drops out for vehicles with an electric propulsion system. For hybrid vehicles, the complete equation is used.

Due to the large number of batteries required for most UAM vehicle designs, an equation was introduced to account for the cost of the batteries. The total cost of batteries was estimated as ( $C_{BAT}$ ), which depends on the mass of the batteries ( $m_{BAT}$ ), the battery density ( $\rho_{BAT}$ ) and the cost per battery cell ( $R_{BAT}$ ). Battery cost is given by:

$$C_{BAT} = m_{BAT} \cdot \rho_{BAT} \cdot R_{BAT}$$

where  $m_{BAT}$  is the total mass of batteries,  $\rho_{BAT}$  is the energy density of the batteries in kWh/lb, and  $R_{BAT}$  is the cost of batteries per kWh.

Based on the available data recorded in the UAM database, the average battery mass for an electric vehicle is about 34.5% of the MTOW of the vehicle. Figure 3.87 shows the electric vehicles' battery weight normalized with the MTOW aircraft. This normalized value is plotted against the vehicle's range, showing no clear relationship between the vehicle's performance and the battery mass. This information was available for 14 vehicles from the complete database and 2 from the Top 10+ subset. The battery weight was only available for one hybrid vehicle and it accounted for approximately 20% of the vehicle's MTOW.

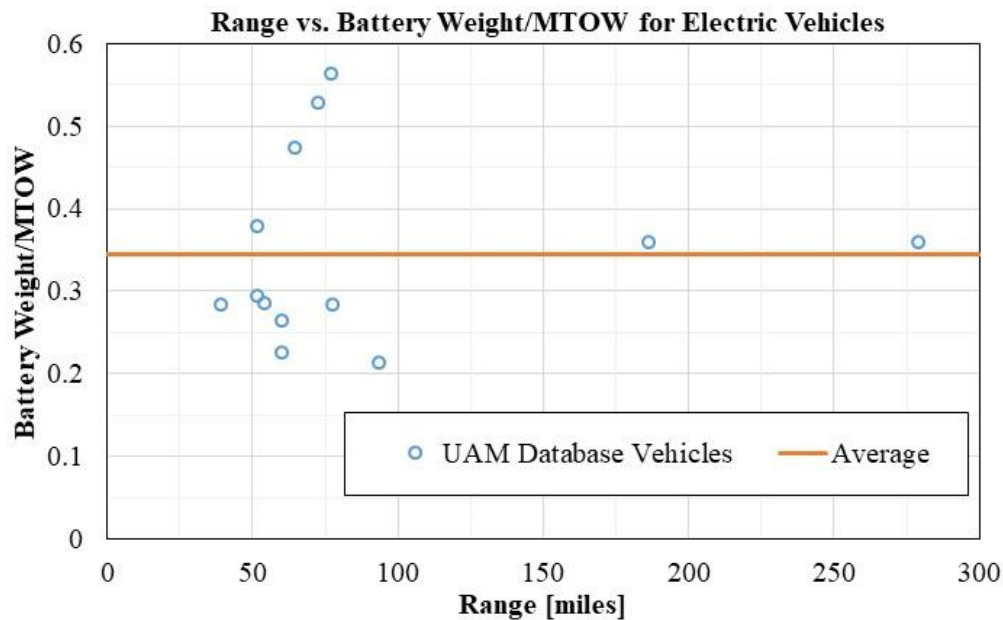

Figure 3.87 Battery weight to MTOW Ratio vs. UAM aircraft range for database aircraft.



### 3.3.2.2.3 Propeller Cost Modification

DEP and RPM control allow engineers to equip most UAM vehicles with fixed-pitch propellers, reducing vehicle complexity and cost compared to variable-pitch propellers. Since the size of the propellers varies significantly amongst UAM configurations due to differences in the number of rotors, the fixed cost of \$3,145 for a propeller was thought to be an inappropriate estimate of the cost of UAM propellers. A market survey was conducted for the retail price of composite propellers, which vary in size and number of blades. An initial power-fit model was applied to the available 2-bladed propellers with an  $R^2$  of 0.796 for a survey size of 13 propellers. The final model includes sensitivity to the number of propeller blades. The survey data, along with the regression model curves for various blades, is presented in Figure 3.88. The final expression for the cost of the propeller is given by:

$$C_{PROP} = \left( \frac{N_{BLADES}}{2} \right)^{0.3} 0.1707 \cdot D^{5.3917}$$

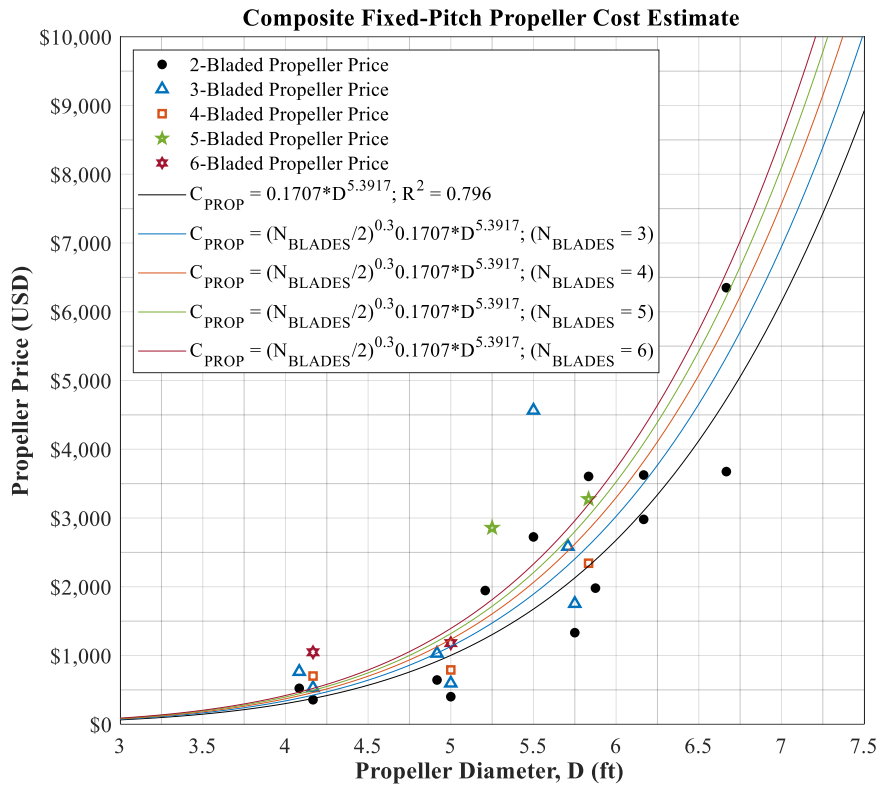

Figure 3.88 Composite, fixed-pitch propeller prices based on diameter and number of blades.

When applying this modified Eastlake model to UAM vehicles, propeller diameters were estimated using vehicle drawings. Utilizing the vehicle's wingspan or other known dimensions, a scale was determined for the drawing or picture, and the rotor diameter measurement was scaled accordingly.

Propeller measurements were used to determine that the average disk loading of UAM vehicles was approximately 10 lb/ft<sup>2</sup>. Using the relationships shown in Figure 3.89, the average disk loading was used to estimate a gross weight-to-power ratio of the vehicles of 4 kg/kW or 8.82 lb/kW. This relationship was used to estimate the electric motor power for each vehicle.

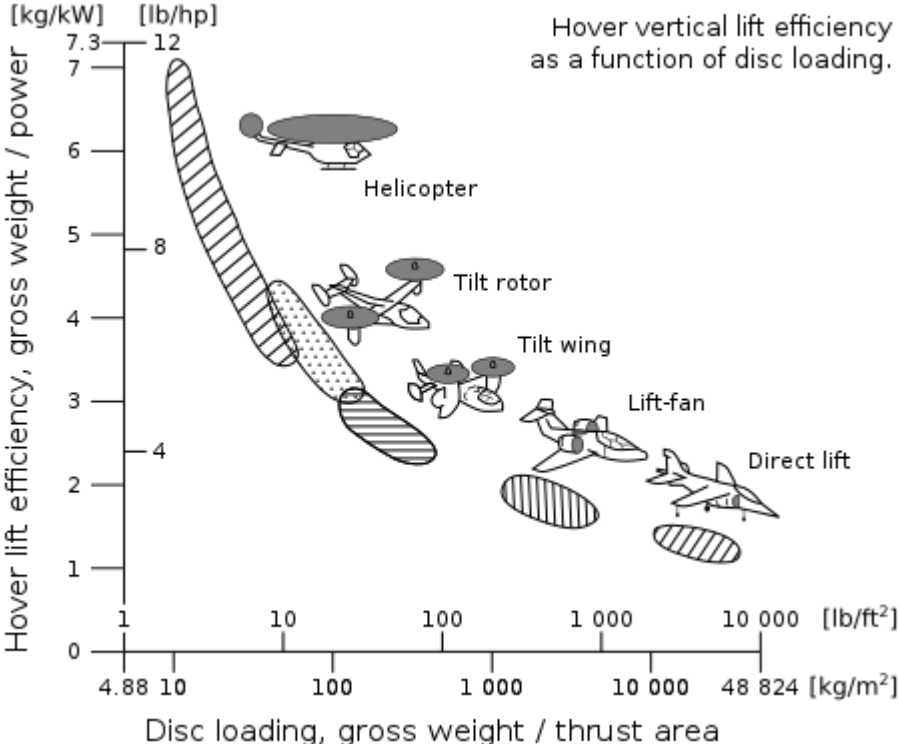

Figure 3.89 Diagram of correlation between disc loading and hover lift efficiency for various VTOL aircrafts such as helicopters, tiltrotors, tilt wings, lift-fan (F-35B), and lift-jets (Harrier). Reproduced from (Maisel et al., 2000).

**3.3.2.3 Application of Modified Eastlake Model to UAM Top 10+**

A set of UAM vehicles from the Top 10+ subset of the database with sufficient publicly available information were selected to test the modified Eastlake Model code. These vehicles and the design characteristics that are used in the Eastlake model are listed in Table 3.19. The design characteristics that affect the scaling factors in the code are outlined for each vehicle in Table 3.20. None of the vehicles assessed had a pressurized cabin, so  $F_{PRESS}$  was universally 1 and not included below.

The certification cost from the Eastlake model is a function of the number of units produced. Therefore, the model was applied assuming a single unit was produced. The results from the modified Eastlake model are presented in Figure 3.90. The output from the model estimates a certification cost much smaller than what was expected based on the available literature. Some available information estimates that certifying a single UAM vehicle could cost approximately one billion dollars (Blain, 2021). The modified Eastlake model estimates a certification cost for UAM vehicles of less than 10% of Blain’s estimate. While this quoted figure may be in error, it would be surprising for the industry to overestimate costs by a factor of 10.

Table 3.19 UAM Top 10+ vehicles and performance parameter inputs for Modified Eastlake model.

OEM	Vehicle	Top Speed (mph)	MTOW (lb)	Number of Electric Motors	Electric Motor Power (hp)	Propeller Diameter (ft)	Number of Propeller Blades (main propellers)
Joby Aviation	S4 1.0	200	4000	6	101.36	7.85	5
Beta Technologies	ALIA-250c	130	6000	5	228.06	12.97	2
Lilium	Jet 4 PAX	186	2866	36	12.1	0.862	28
Wisk	Cora	100	4350	12	25.34	4.83	2
Ehang	216	81	1322	16	12.56	4.65	2
Volocopter	Voloconnect	155	4000	6	101.36	7.85	2
Volocopter	VoloCity	68	1984	18	16.76	9.3	2
Pipistrel	Nuuva V300	137	3750	8	71.27	6.57	2
Hyundai	S-A1	180	7000	8	133.04	11.7	5
Astro Aerospace	Elroy	44	793	16	7.54	5.78	2
Vertical Aerospace	VA-X4	202	4670	8	76.02	10.17	5

Table 3.20 UAM Top 10+ vehicle architecture types used for scaling factor inputs.

OEM	Vehicle	Tilt	Autonomous	Electric / Hybrid	Complex / Simple Flap	Taper
Joby Aviation	S4 1.0	Yes	No	Electric	Simple	Yes
Beta Technologies	ALIA-250c	No	No	Electric	Simple	Yes
Lilium	Jet 4 PAX	Yes	No	Electric	Complex	Yes
Wisk	Cora	No	Yes	Electric	Simple	No
Ehang	216	No	Yes	Electric	Simple	No
Volocopter	Voloconnect	No	No	Electric	Simple	Yes
Volocopter	VoloCity	No	No	Electric	Simple	No
Pipistrel	Nuuva V300	No	Yes	Hybrid	Simple	Yes
Hyundai	S-A1	Yes	No	Electric	Simple	No
Astro Aerospace	Elroy	No	Yes	Electric	Simple	No
Vertical Aerospace	VA-X4	Yes	No	Electric	Simple	Yes

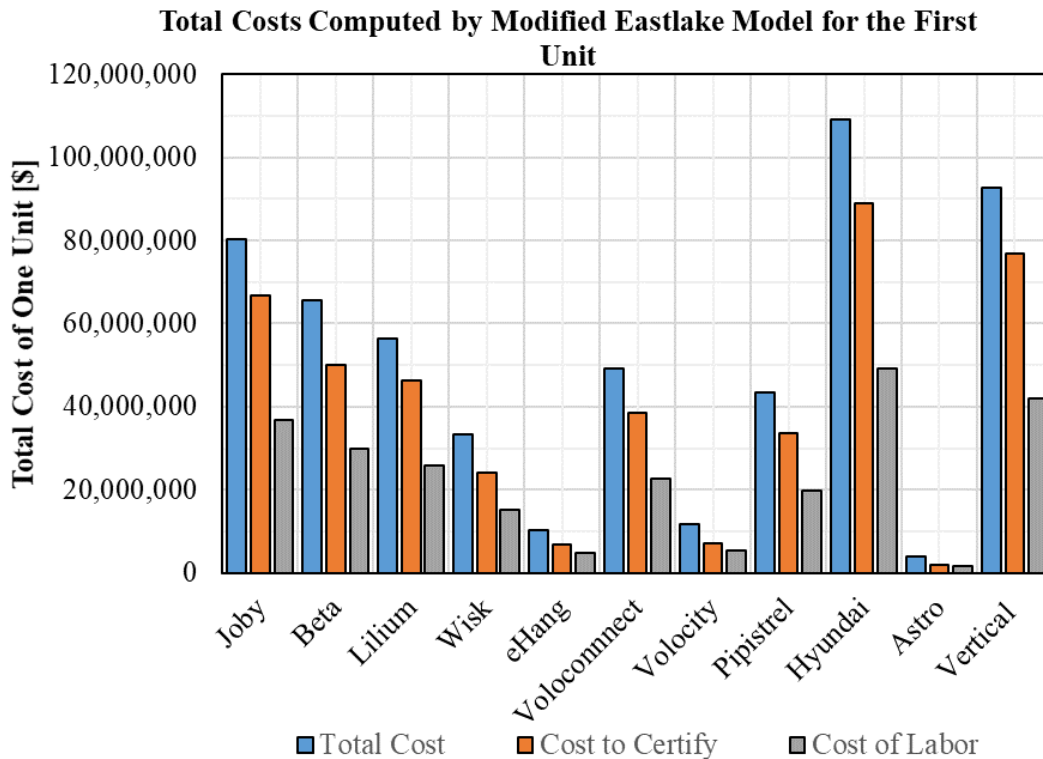

Figure 3.90 Estimated certification cost for the first unit based on the modified Eastlake model.

The contributing costs within the model were assessed to better understand the apparent underestimation of the modified Eastlake model. As seen in Figure 3.90, the cost of labor was estimated to account for over half of the cost of certifying each aircraft. When this labor is broken down further into engineering, tooling, and manufacturing hours, as shown in Figure 3.91, it can be seen that most of the cost stems from the engineering hours, which make up the majority of the estimate for all but the smallest UAM vehicles. While the relationship between the labor segments appeared reasonable, the estimated number of hours appeared low to the authors as a full-time employee would contribute around 2,000 hours per year.

In an attempt to understand the underestimation of the total cost, the total number of hours invested by engineers for each company was calculated using a top-down approach. Since there is no way to separate the number of hours for engineering, tooling, and manufacturing using the top-down approach, it was assumed that the engineers employed would be working in one of these disciplines.

The top-down approach was applied as follows:

- LinkedIn was used to approximate the current number of employees. This estimate was confirmed, when possible, using company or news reports. If a direct number of engineering employees was available, this was noted and used as an input for a year.

- If the number of engineers employed was not available, a ratio of engineers to employees based on UAM companies for which this data was available was used, which was approximately 60%.
- Employment history reports were used to determine the number of employees at different times. Employment data was interpolated between existing data.
- The number of hours worked for that year was estimated using 48 weeks worked per year and 40 hours per week.

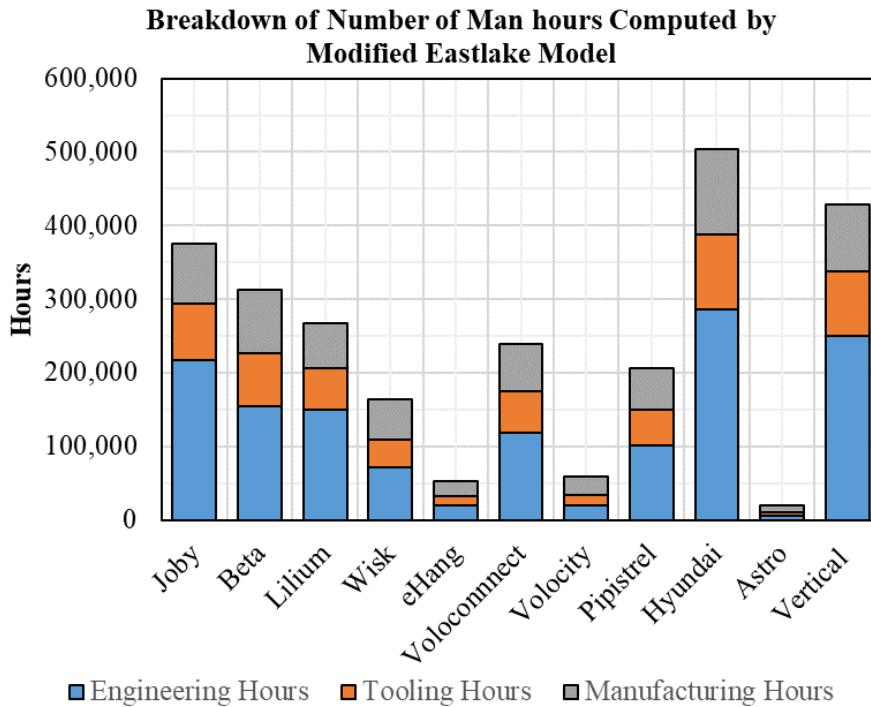

Figure 3.91 Breakdown of the number of person-hours estimated by the modified Eastlake model.

A comparison of the estimated labor hours of engineers from each company’s inception through 2022 and the total number of hours for engineering, tooling, and manufacturing from the modified Eastlake model are presented in Table 3.21 for the vehicles for which sufficient employment data was available. In general, the modified Eastlake model underestimates the number of hours invested in each of these programs by between 5 and 10 times, with the exception of Vertical Aerospace. Additionally, the top-down approach does not include outsourced work related to the development of the program, which could be significant for some of these companies.

Table 3.21 Comparison of engineering hours estimated by the modified Eastlake model and a top-down estimation approach using publicly available data.

<b>Aircraft</b>	<b>CER Engineering Hrs.</b>	<b>Estimated Hours Top-Down</b>
<b>Joby Aviation S41</b>	375,618	3,360,000
<b>Beta Tech Alia 250</b>	313,072	2,586,169
<b>Wisk Cora</b>	162,992	1,062,885
<b>Vertical Aerospace VA-X4</b>	429,267	668,000
<b>Lilium Jet 4 PAX</b>	266,790	2,229,040

### 3.3.2.4 Eastlake Model limitations

After examining the results from the Eastlake model and the comparison to the top-down approach, the authors noted two potential deficiencies in the Eastlake model. While there is insufficient evidence to specify whether either or both of these deficiencies were the most significant driver of the underestimation, both exhibited merit.

The first deficiency stems from the development of the Eastlake model. When discussing the development of the model, Eastlake and Blackwell noted that: "...a second phase of adjustment was made to force the equations to predict the correct current price of a Cessna 172" (Eastlake & Blackwell, 2000). While it is unclear whether this calibration occurred near the time of the article or during the model's original development in the late 1980s, the Cessna 172 was not a new plane design when it was used to calibrate this model. As such, the sales price of this aircraft was not necessarily representative of the original development costs of the aircraft. Additionally, when considering the Cessna 172 as a standard, there is some evidence that it was not a clean-sheet design from its inception. Basic parameters for five civilian aircraft developed by Cessna between 1945 and 1957 are presented in Table 3.22. These aircraft exhibit significant similarities in their overall size and performance. Cessna made incremental improvements over this development window, but these aircraft were generally exceedingly similar. This likely saved considerable engineering and design efforts compared to an entirely new aircraft design.

The second significant limitation of this model is a lack of accounting for the increased reliance on technology and increased safety regulations. Without an update of the model to account for these increased regulations, additional costs incurred to satisfy regulatory requirements are not captured. Reliance on increased amounts of technology increases the engineering complexity of the vehicle, which in turn increases the time and cost to certify an aircraft. Hess and Romanoff noticed this trend with regards to the DAPCA IV model's under-prediction of aircraft cost towards the end of its development, where they noted that the costs increased were "a result of the combined effects of numerous design-related and institutional changes that have occurred over the 1948-1978 time period (e.g., the increased emphasis on electronics, along with changes in materials of construction, manufacturing process, and the regulatory framework)" (Hess & Romanoff, 1987b).

Table 3.22 Basic size, weight, and performance parameters for aircraft developed by the Cessna Aircraft Company in the years preceding and immediately following the development of the Cessna 172.

	<b>140</b>	<b>120</b>	<b>170</b>	<b>172</b>	<b>150</b>
First Model Year	1946	1946	1948	1956	1959
Gross Weight (lb)	1,450	1,450	2,200	2,200	1,500
Clean Stall Speed (kts)	39	32	48	50	48
Cruise Speed (kts)	91	92	106	116	106
Service Ceiling (ft)	15,500	15,500	15,000	15,100	15,300
Take-off 50 ft (ft)	1,850	1,850	1,460	1,650	1,385
Landing, 50 ft (ft)	1,530	1,530	1,580	1,115	1,055
Rate of Climb (ft/min)	640	640	690	660	670
Range (mi)	450	450	571	540	350
Wingspan (ft)	33.3	33.3	36	36	33.3
Wing Area (ft <sup>2</sup> )	159.5	159.5	174	174	159.5

Note. Data contained in the table obtained from *Standard Catalog of Cessna Single Engine Aircraft*, Ed. Jim Cavanagh, 1995. Copyright 1995, Jones Publishing, Inc.

### 3.3.3 NASA Advanced Missions Cost Model

Created as a long-range cost forecasting tool, the AMCM was developed at the Johnson Space Center to estimate project development costs out 25 to 50 years (Jones, 2015). The AMCM is a single equation model with six independent inputs. Three of the inputs are easily understood, including the system's dry mass (or weight) in pounds,  $M$ ; the total number of development and production units  $N$ ; and the year of Initial Operational Capability,  $IOC$ . The fourth input, the hardware generation or block number, is a measure of incremental modifications to a project that may have slight modifications to the hardware. The final two inputs are coded inputs for the mission type,  $S$  and the project difficulty,  $D$ . The model estimates the total cost of Design, Development, Testing, and Evaluation (DDT&E) for the project. Using Greek symbols for empirical constants and capital letters for the variable inputs, the AMCM is:

$$C = \alpha N^\beta M^\gamma \delta^S \epsilon^{(1/IOC-1900)} B^\zeta \eta^D$$

The empirical constants are:  $\alpha = 5.04839 \times 10^{-4}$ ,  $\beta = 5.94183076 \times 10^{-1}$ ,  $\gamma = 6.53947922 \times 10^{-1}$ ,  $\delta = 7.69939424 \times 10^1$ ,  $\epsilon = 1.68051 \times 10^{-52}$ ,  $\zeta = -3.55322218 \times 10^{-1}$ , and  $\eta = 1.554982942$  (GlobalSecurity.org, 2005). Other sources provide empirical constant values about 10% different than those presented here (Larson & Pranke, 1999). The inputs referenced here are based on direction from inquiries made with cost estimation personnel at NASA. Resulting estimates from the AMCM are provided in millions of dollars in 1999. Unless otherwise specified, cost estimates presented in this document are adjusted to cost in 2021 using CPI.

While targeted explicitly toward space systems, the AMCM was developed using historical data from 54 spacecraft, 22 space transportation systems, 61 aircraft, 86 missiles, 29 ships, and 18 ground vehicles (Lukacs, 2009). The large variety of input vehicles allowed the developers to fit the model to a wide variety of vehicle types, using the numerically coded mission type,  $S$ , to adjust the model

for each. Representative values of  $S$  and the corresponding aircraft types are shown in Table 3.23 (GlobalSecurity.org, 2005). Missions with the highest and lowest values of  $S$  are included in the table for comparison. In total, there are more than 45 categories across ground vehicles, naval vessels, aircraft, and spacecraft. No category was developed for general aviation aircraft, but the same mission value, 1.75, represented commercial fixed-wing and rotary transport aircraft. Transport rotorcraft is likely the most similar mission category to UAM vehicles.

Table 3.23 Numerical values used to code AMCM mission specification.

Mission Type	$S$
Aircraft – Attack	1.97
Aircraft – Bomber	1.99
Aircraft – Commercial	1.75
Aircraft – Fighter	1.91
Aircraft – Patrol	1.93
Aircraft – Rotary Transport	1.75
Aircraft – Transport	1.67
Aircraft – Trainer	1.48
Spacecraft – Planetary Lander	2.46
Land Vehicle - Truck	0.87

The estimated difficulty is another coded input, ranging between -2.5 to 2.5, with -2.5 being very easy, 0 for a project with average difficulty, and 2.5 corresponding to a very difficult project (Owens, 2016). This input is subjective to the opinion of the analyst estimating the project's cost and could vary based on the capabilities or historical accomplishments of the developing agency or company in addition to the perceived difficulty of the project itself. Unfortunately, additional guidelines were not found during this investigation to guide the selection of the value of difficulty.

Being that the model was intended primarily for usage for spacecraft, the year of *IOC* is difficult to select for aircraft. For spacecraft, this input is likely the year of launch or potentially the year of commissioning for projects with further development or testing after deployment. However, many years can elapse between the first flight of an aircraft and its introduction into service or receipt of the type certificate. Because the AMCM is intended to estimate the design, development, testing, and evaluation costs, which include efforts that occur after the first flight, it is likely more appropriate to establish *IOC* as the year a civilian aircraft receives its type certificate.

### 3.3.3.1 Application of AMCM to Clean-Sheet Design Aircraft

Since the AMCM was applied in this study to a novel aircraft segment, it was first used to analyze two clean-sheet design aircraft from the last 30 years: the HondaJet HA-420 and the Pilatus PC-12. These aircraft were selected for two primary reasons. First, there was some publicly available information on these aircraft development costs. Secondly, both were general aviation aircraft and were similar in size to some of the vehicles in the UAM database, though both are heavier than most



of the database. The estimated cost for each of these aircraft served to provide a benchmark of the model and help to characterize inputs for *IOC*, *S*, and *D*.

Estimates for HondaJet’s development cost range from \$1 billion in 2017 (\$1.1 billion in 2021) made by the Teal Group to between \$1.5 and \$2 billion from Forbes in 2015 (\$1.7 to \$2.3 billion in 2021) (Muller, 2015). During the development period, four prototype HA-420 aircraft were built for flight testing (*HondaJet Nears Final Type Certification*, 2015). Earlier in the development cycle, two additional prototype aircraft were built and tested, the MH01 and the MH02. The HA-420 had its first flight in 2003 and received its FAA type certificate in 2015.

Similarly, estimates of the development cost of the Pilatus PC-12 were \$700 million in 1994 (\$1.3 billion in 2021) (Leitch, 2021). Two flight-test aircraft were built in 1991. Final type certification for the PC-12 was provided in 1994, slightly later than initially planned, due to a late-stage redesign of the wing to meet performance goals (Frawley, 2003).

The AMCM was applied to both aircraft using the values in Table 3.24. For both aircraft, two values were used for the *IOC* and *S*. The *IOC* years chosen were those of the first flight or receipt of the type certificate for each aircraft. Mission type was varied between transport aircraft (1.67) and commercial aircraft (1.75). For all configurations, the difficulty was varied from -2.5 to 2.5 in increments of 0.5. The number of flight-test aircraft for the final design was used for *N*. For the PC-12, this number was adjusted to 3 as the late-state wing redesign was suspected of requiring remanufacturing of one or both flight test aircraft. A subsequent analysis was performed for the HA-420 with an additional aircraft ( $N = 5$ ) to understand the impact of additional aircraft. For both aircraft, the dry mass was estimated as the aircraft's empty weight.

Table 3.24 Inputs for AMCM for two clean-sheet general aviation aircraft designs from the past 30 years.

AMCM Input	Pilatus PC-12	HondaJet HA-420
<i>N</i>	3	4
<i>M</i> (lb)	5,732	7,203
<i>S</i>	1.67 and 1.75	1.67 and 1.75
<i>IOC</i>	1991 and 1994	2003 and 2015
<i>B</i>	1	1
<i>D</i>	-2.5 to 2.5	-2.5 to 2.5

Estimates for the development costs of the Pilatus PC-12 are shown in Figure 3.92. The AMCM underestimated the cost of development for all inputs used for the development. Assessment of factors contributing to the difficulty of the project, the authors believe that a difficulty between 1 and 1.5 would be most appropriate for this aircraft. While the PC-12 was a new design, other aircraft of similar design and mission had been flying for several decades. The novel aspect of a single-engine aircraft entering into this space was deemed to contribute to the difficulty of the design. The late-stage wing redesign during the development of the aircraft is believed to explain some of the underestimations in the development costs.

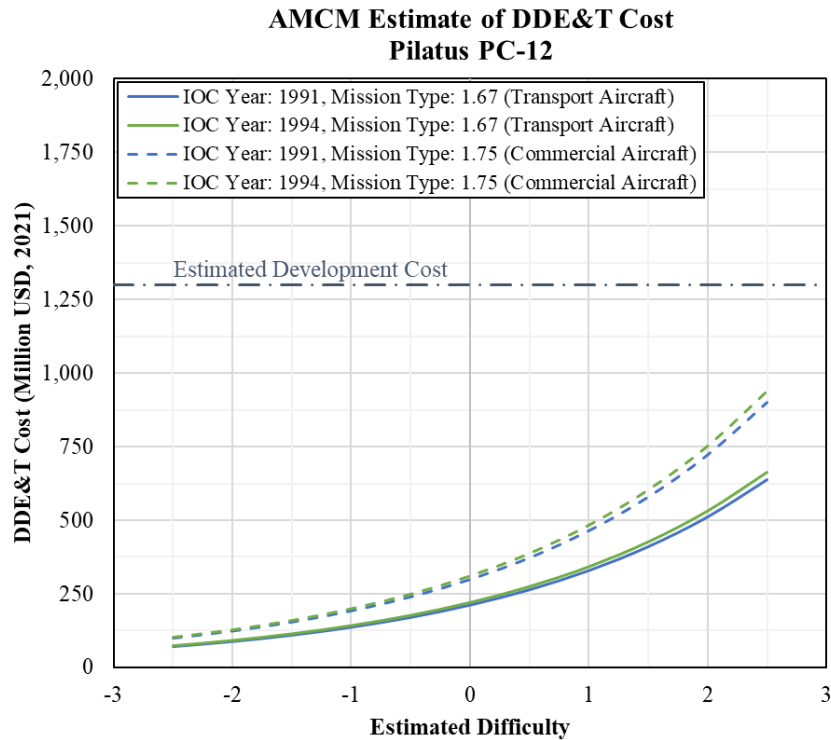

Figure 3.92 AMCM estimate of DDE&T costs for the Pilatus PC-12.

Estimates of the DDT&E costs for the HA-420 are presented in Figures 3.93 and 3.94. Figure 3.93 shows the results from the AMCM for  $N = 4$ . As can be seen, the model estimates fall within the range of development cost estimates for higher values of  $D$ . When considering the additional flight test aircraft, Figure 3.94 shows an increase in DDT&E of about 14%. The difficulty of the HA-420 is estimated to be in the range of 1.5 or 2, owing to this being the first aircraft developed by the company, and being this a novel design, owing to the location of the nacelles.

The following AMCM input variables for UAM vehicles were established based on the data for these two aircraft. The *IOC* year should correspond to the year a design received its type certificate because significant evaluation and testing occur during flight tests, after the first flight of an aircraft. The number of prototype aircraft should be used for  $N$ . The mission should be considered a commercial aircraft,  $S = 1.75$ . The difficulty should be considered 2.5 due to the novelty of UAM designs, the reliance on new technologies, and the inexperience of most companies. Additionally, the difficulty of certifying these vehicles, which require new or modified certification guidelines, adds to the overall difficulty of the project.

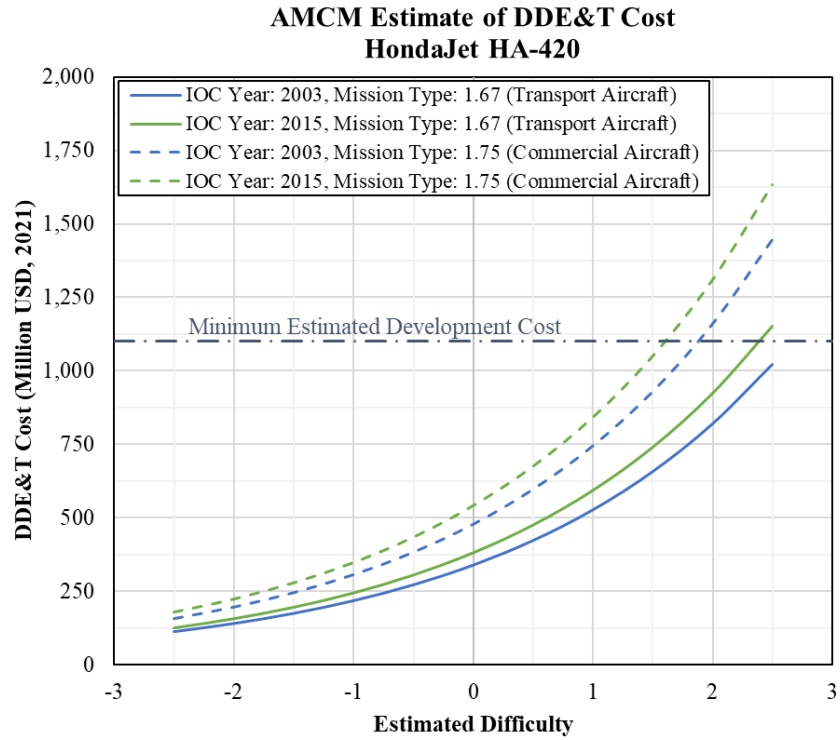

Figure 3.93 AMCM estimate of DDE&T costs for the HondaJet HA-420.

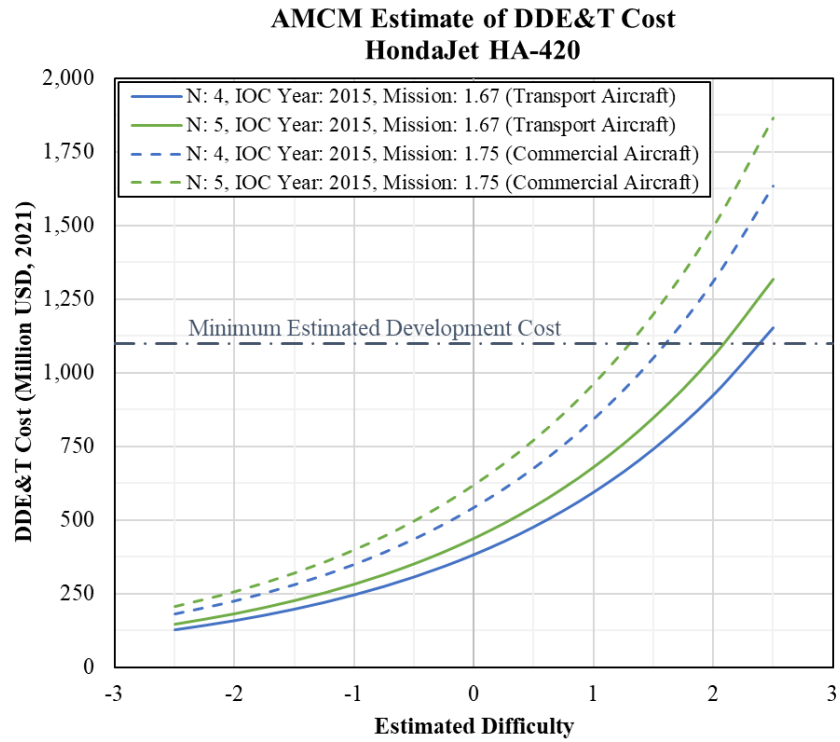

Figure 3.94 Impact of the number of prototypes on the AMCM estimate of DDE&T costs for the HondaJet HA-420.

### 3.3.3.2 Sensitivity Analysis

Because many of the inputs to the AMCM are either subjective or estimates with little available information to guide predictions for UAM vehicles, a sensitivity study was performed to understand the impact each variable had on the result. A baseline set of inputs to the AMCM were selected and are presented in Table 3.25. Each of the inputs was varied from this baseline value in both directions within a reasonable range (e.g., at least one prototype is required for meaningful outputs, no vehicles in the Top 10+ segment of the database weighed less than 300 pounds, etc.). Block number was only increased as there is no meaning for a “Block 0” configuration. The results from this analysis are presented in Figure 3.95 in terms of percentage change in DDE&T cost estimate. Inputs for vehicle dry mass and the number of prototypes are given in percentage of baseline input.

The mission type and difficulty are the most sensitive in terms of effect. These are also the most difficult to estimate accurately for UAM vehicles. A very difficult project ( $D = 2.5$ ) is estimated to be three times as expensive as an average difficulty program ( $D = 0$ ). Similarly, the estimated cost savings of a program designing a fixed-wing transport aircraft ( $S = 1.67$ ) versus an equivalent transport rotorcraft ( $S = 1.75$ ) is roughly 30% of the project’s cost.

Table 3.25 Baseline inputs for AMCM sensitivity analysis.

AMCM Input	Baseline Value
$N$	5
$M$ (lb)	3,000
$S$	1.75
$IOC$	2025
$B$	1
$D$	0

For preliminary budgeting purposes, accuracy in the aircraft weight is not critical. A 30% over- or under-estimation changes program cost by only 20%. Block number, while moderately sensitive, is likely one of the easiest parameters to estimate for these programs. Projects are usually clearly defined as a modification of an existing design or as a clean-sheet design. Finally, the initial year of operational capability had a minimal effect. Estimation of program cost would exhibit a similar effect to the other parameters if  $IOC$  was adjusted by 10 to 20 years.

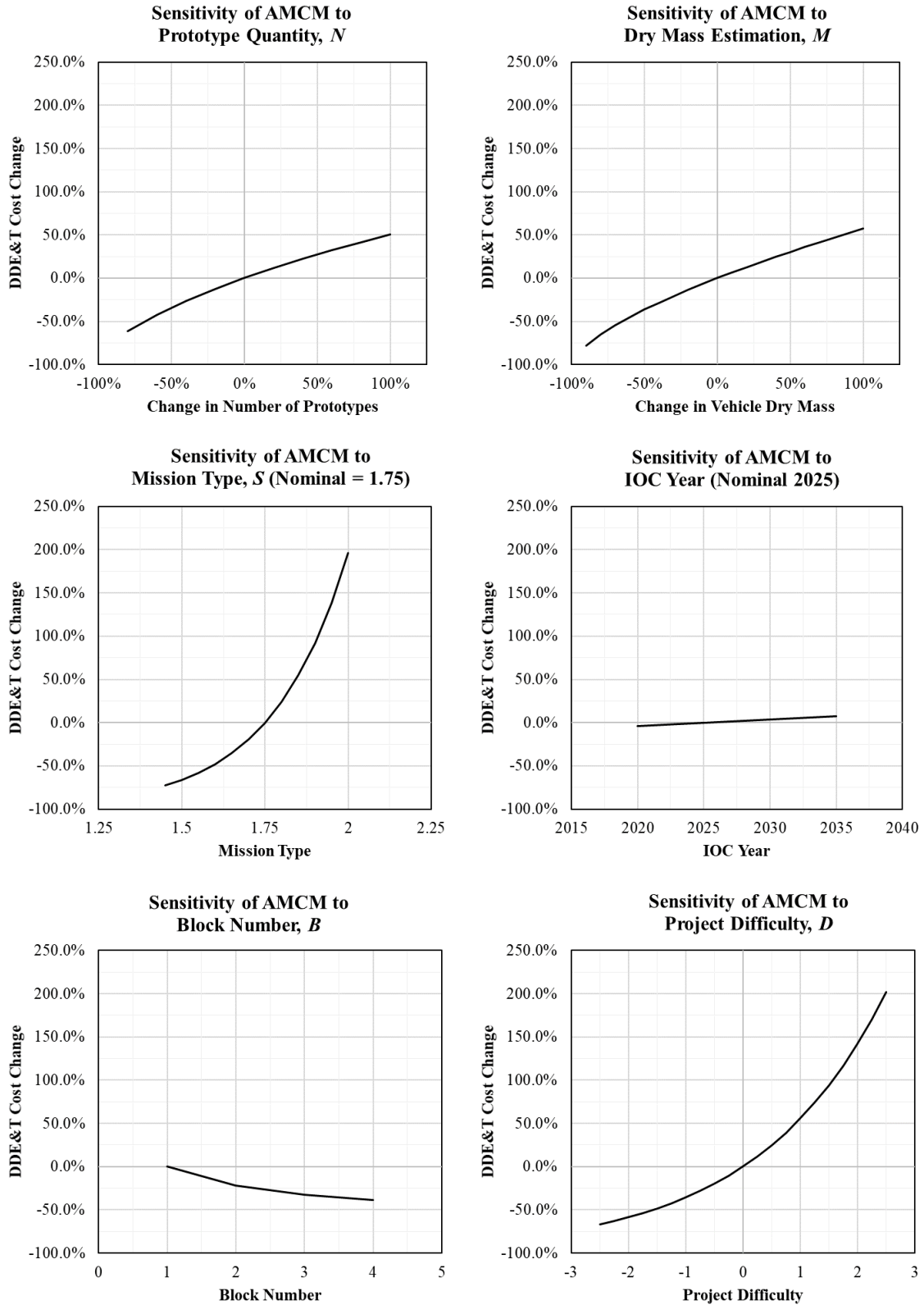

Figure 3.95 Sensitivity analysis of AMCM.

### 3.3.3.3 Application of AMCM to vehicles in UAM Top 10+ Database

The same aircraft previously analyzed for the UAM Top 10+ Database using the modified Eastlake model were also evaluated using the AMCM. Input values for the model are provided in

Table 3.26. The assumptions made for the model inputs are:

- The dry mass was approximated by the MTOW less the designed payload. The mass of batteries was included because they are more similar to aircraft system hardware than they are to fluids like hydraulic fluid or fuel.
- The number of prototypes was held constant at five. Based on available news releases, this appeared to be a reasonable number. However, this is likely the most widely varying input, and the total number of prototypes for each vehicle could reasonably be assumed to be between two and ten without significant surprise. This was held constant across the study due to a lack of detailed information available from most companies.
- Block number was established as 1 for each of the vehicles. Because none of the UAM vehicles is a direct derivative of a completed program, from the perspective that none of the considered aircraft has received a type certificate, each project was treated as a new design rather than a derivative program. It was thought possible that a further breakdown of costs could be produced at each step of the program that a fully functional vehicle was prototyped and then used to develop a subsequent, certified design. However, this level of granularity was not pursued as the confidence in the input data was insufficient to justify adding complexity to this model.
- Mission specification was established as  $S = 1.75$ , representing a transport rotorcraft. All vehicles in the database utilize eVTOL technology, which is most closely aligned with rotorcraft.
- The difficulty of developing UAM vehicles was deemed very high ( $D = 2.5$ ) because UAM vehicles are novel without previously certified aircraft with which to compare. In addition, technologies such as distributed electric propulsion (DEP) being employed are untested in aerospace applications, and most companies in the UAM market lack experience certifying an aircraft.
- The *IOC* was held constant at 2025. This was selected due to the small impact of the year of vehicle *IOC* and the lack of reliable information for when most vehicles in the database would receive a type certificate.

The resulting variations in DDE&T cost estimates are strictly due to the weight of the vehicles. The results can be scaled based on the sensitivities determined in Section 3.3.3.2 as better information becomes available.

Figure 3.96 shows the estimated program costs for each of the vehicles analyzed. The current estimates range from a low of \$367 million for the Astro Aerospace Elroy to a maximum of \$1.83 billion for the Hyundai S-A1. Figure 3.97 shows a comparison between the AMCM and the modified Eastlake model. The modified Eastlake model estimates development costs between 0.6% and 5.9% of those predicted by the AMCM, depending on the vehicle considered. While there is insufficient information to establish the accuracy of either model when applied to UAM vehicles, the projections from the AMCM align more closely with news reports for funding received and cost estimates following the top-down approach for engineering person-hours.

Significant consideration is warranted as to whether companies would be able to fund projects at the cost predicted by the AMCM. Very few companies have publically acknowledged funding levels near \$1 billion or more. There are two very real possibilities when considering these numbers. First, the cost estimates from the AMCM could be inflated. While likely not incorrect by an order of magnitude, an overestimation by a factor of two or four times is plausible. Second, many companies may be underestimating the cost to certify a new aircraft. Many of the largest startups in this field have undergone several rounds of fundraising through various methods. It will only be after several UAM vehicles are certified that the extent of either of these possibilities, or the impact of others not considered here, is established.

Table 3.26 AMCM inputs for UAM Database Top 10+ vehicles.

<b>Vehicle</b>	<b>Weight M (lb) (=MTOW – Payload)</b>	<b>Quantity N</b>	<b>Mission S</b>	<b>IOC Year</b>	<b>Block B</b>	<b>Difficulty D</b>
Joby S4 1.0	3,150					
Beta Technologies Alia-250	4,980					
Lilium Jet (4 Pax)	2,016					
Wisk Cora	3,610					
Ehang 216	837					
Volocopter Voloconnect	3,320	5	1.75	2025	1	2.5
Volocopter VoloCity	1,543					
Pipistrel Nuuva V300	2,736					
Hyundai S-A1	6,150					
Astro Aerospace Elroy	528					
Vertical Aerospace VA-X4	3,678					

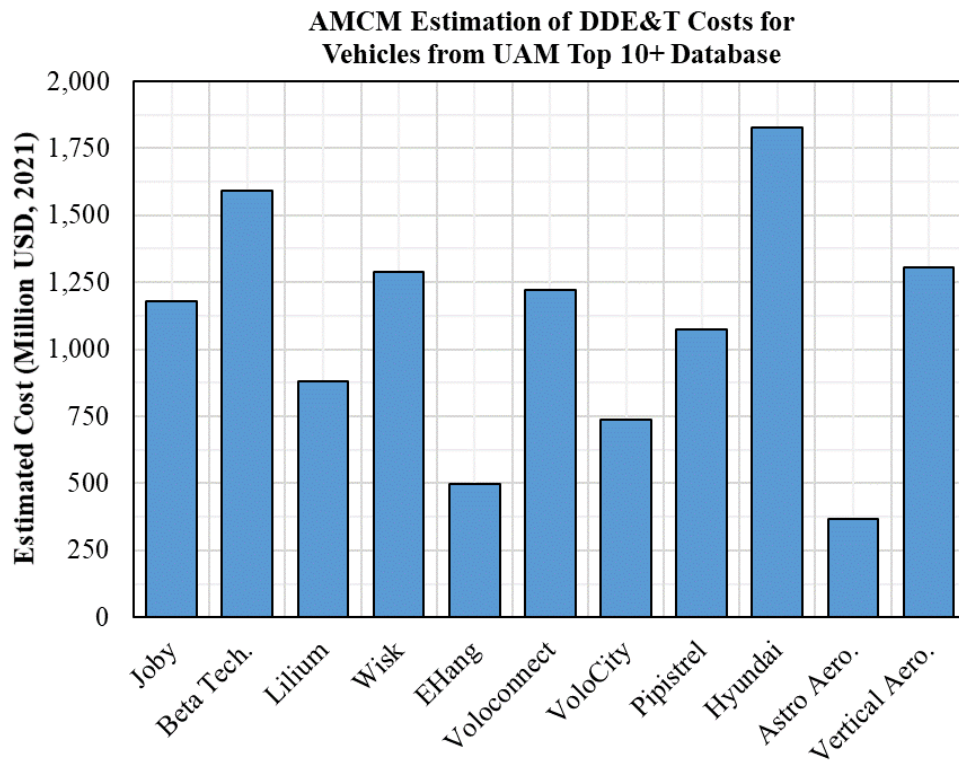

Figure 3.96 AMCM project cost estimates for UAM Database Top 10+ vehicles.



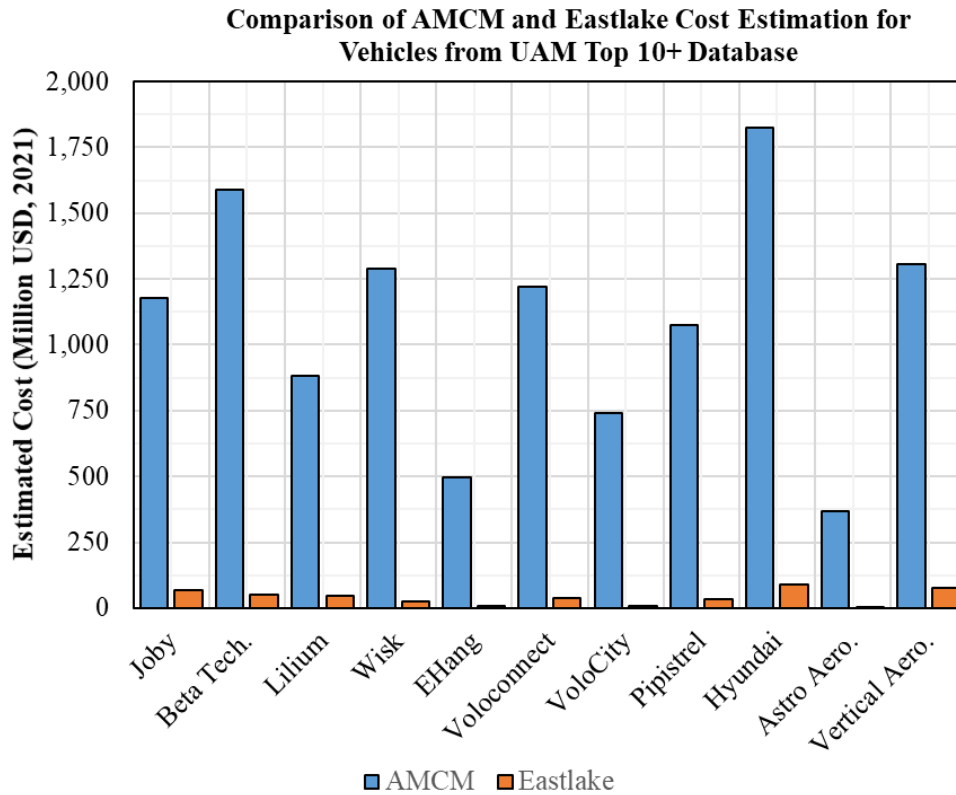

Figure 3.97 Comparison of AMCM and Eastlake model project cost estimates for UAM Database Top 10+ vehicles.

### 3.3.4 UAM Program Cost Estimation Conclusions

Based on the publicly available information and the three models considered, the application of the AMCM appears to provide the most realistic estimates for certification costs for UAM vehicles. This conclusion is based on the comparison of publicly available information on funding raised by companies developing UAM vehicles. Unfortunately, the AMCM doesn't output any granularity in the cost estimate. Again, it should be noted that certification costs here are inclusive of much of the development cost of a vehicle due to the complexity of design activities that may have been less expensive had the design not been intended to meet regulatory requirements. The modified Eastlake model appears to significantly underestimate the costs involved with the development of a UAM vehicle.

A more robust and detailed set of CERs for UAM vehicles would require companies' detailed expenditure and labor data. Without this information, such as what was available for the development of the DAPCA IV model, a more accurate model cannot be developed. Additionally, these data will only be available after several companies have brought vehicles to market to allow analysis of certification (and development) costs. Additionally, the wide variety of UAM architectures would likely require a complex set of CERs or perhaps even preclude the possibility of developing a single, universal tool for cost estimates in this market segment.

### 3.4 Conclusions

From the information gathered during the development of the database in Section 3.1, it is possible to classify UAM aircraft by categories in terms of airworthiness. These categories have been defined as Vectored Thrust, Lift + Cruise, Wingless Multicopter, and Electric Rotorcraft. Nevertheless, an airworthiness requirement may differ for different aircraft in the same category depending on their unique mission and characteristics. As stated previously, there are aircraft that depending on the mission type, can change their configuration, such as the Sabrewing Raegal RG-1.

Due to the novelties of UAM aircraft, it is possible to state that current regulatory frameworks for conventional aircraft, although useful, are insufficient and cannot address all the characteristics of these novel aircraft. Leveraging the current regulations, an initial framework for UAM aircraft (in the form of special conditions) would need more requirements and potential modifications. In particular, areas that involve vertical take of landing, autonomous flying, operation environment, VTOL and battery crashworthiness, and noise would need to be reviewed and revised to adapt to the specific needs of the UAM aircraft. In particular, the researchers identified that additional research is needed in the area of crashworthiness so that an equivalent level of safety for UAM users can be provided.

In addition, the certification cost of these novel aircraft is unknown. Two models were evaluated and compared using public-domain data. Although the AMCM seems to provide the most realistic estimates for certification costs based on the available information, several limitations were identified and discussed. UAM companies' expenditure and labor data will be required to develop more robust and detailed cost models. Finally, it is worth mentioning that due to the wide variety of UAM architectures, different cost models may be required to consider the UAM vehicle's specific characteristics.

### 3.5 References

- Alvarez, E. J., Schenk, A., Critchfield, T., & Ning, A. (2020). Rotor-on-Rotor Aeroacoustic Interactions of Multicopter in Hover (in review). *Journal of the American Helicopter Society*.
- Angerer, J. R., McCurdy, D. A., & Erickson, R. A. (1991). *Development of an Annoyance Model Based Upon Elementary Auditory Sensations for Steady-State Aircraft Interior Noise Containing Tonal Components (NASA-TM-104147)*.
- ASTM International. (2020, October 9th). ASTM F44 as a Means of Compliance for Part 23. In NASA and FAA, *eVTOL Crashworthiness Workshop Series Workshop #2: Professional Organizations, Stakeholders and Regulatory Approaches for Crashworthiness for eVTOL Vehicles*, Online.
- ASTM International. (2021). *Standard Specification for Normal Category Aeroplanes Certification*. (F3264-21).
- Avdeev, I., Martinsen, M., & Francis, A. (2014). Rate- and Temperature-Dependent Material Behavior of a Multilayer Polymer Battery Separator. *Journal of Materials Engineering and Performance*, 23(1), 315-325. <https://doi.org/10.1007/s11665-013-0743-4>
- Bahr, M., McKay, M., Niemiec, R., & Gandhi, F. (2020). *Handling Qualities Assessment of Large Variable-RPM Multi-Rotor Aircraft for Urban Air Mobility* VFS international 76th Annual Forum & Technology Display, Virginia Beach, VA.
- Baker Mckenzie. (2022). *Regulation and Certification of Electric Vertical Take-off and Landing (eVTOL) Aircraft*. Retrieved February 7th from [https://www.bakermckenzie.com/en/insight/publications/2022/01/regulation-certification-evtol-aircraft?utm\\_source=Electric+VTOL+News&utm\\_campaign=c76219b230-eVTOL+eNews%2C+Sept+29%2C+2017\\_COPY\\_01&utm\\_medium=email&utm\\_term=0\\_5d82db6e49-c76219b230-50827190](https://www.bakermckenzie.com/en/insight/publications/2022/01/regulation-certification-evtol-aircraft?utm_source=Electric+VTOL+News&utm_campaign=c76219b230-eVTOL+eNews%2C+Sept+29%2C+2017_COPY_01&utm_medium=email&utm_term=0_5d82db6e49-c76219b230-50827190)
- Basner, M., Clark, C., Hansell, A., Hileman, J. I., Janssen, S., Shepherd, K., & Sparrow, V. (2017). Aviation Noise Impacts: State of the Science. *Noise Health*, 19(87), 41-50. [https://doi.org/10.4103/nah.NAH\\_104\\_16](https://doi.org/10.4103/nah.NAH_104_16)
- Bell 525 Fact Sheet. (2019). <https://www.bellflight.com/products/bell-525>
- Bennett, R. L., & Pearsons, K. S. (1981). *Handbook of Aircraft Noise Metrics (NASA CR-3406)*.
- Blain, L. (2021). *Lilium's CPO on the massively expensive challenge of eVTOL certification*. New Atlas. Retrieved May 31, 2022 from <https://newatlas.com/aircraft/interview-lilium-chief-program-officer-yves-yemsi>
- Blake, W. K. (2017). Noise From Rotating Machinery. In *Mechanics of Flow-Induced Sound and Vibration, Volume 2* (pp. 505-658). <https://doi.org/10.1016/b978-0-12-809274-3.00006-4>
- Boren, H. E., Jr. (1976). *A Computer Model for Estimating Development and Procurement Costs of Aircraft (DAPCA-III) (R-1854-PR)*. The Rand Corporation.
- Brentner, K. S. (2018). *Rotor Noise Modeling [Presentation Slides]* 5th Annual Transformative Vertical Flight Workshop, San Francisco, CA.
- Celik, A., Jamaluddin, N. S., Baskaran, K., Rezugui, D., & Azarpeyvand, M. (2021). *Aeroacoustic Performance of Rotors in Tandem Configuration* Aiaa Aviation 2021 Forum,
- Coltman, J. W., Bolukbasi, A. O., & Laananen, D. H. (1985). *Analysis of rotorcraft crash dynamics for development of improved crashworthiness design criteria* [Technical Report] (DOT/FAA/CT-85/11). Federal Aviation Administration.
- Conner, D. A., Burley, C. L., & Smith, C. D. (2006). *Flight Acoustic Testing and Data Acquisition For the Rotor Noise Model (RNM)* 62nd American Helicopter Society Forum, Phoenix, AZ.

- Conner, D. A., Edwards, B. D., Decker, W. A., Marcolini, M. A., & Klein, P. D. (2000). *NASA/ARMY/BELL XV-15 Tiltrotor Low Noise Terminal Area Operations Flight Research Program* 6th AIAA Aeroacoustics Conference and Exhibit, Lahaina, HI.
- De Florio, F. (2016). *Airworthiness An Introduction to Aircraft Certification and Operations* (Third ed.). Butterworth-Heinemann. <https://doi.org/https://doi.org/10.1016/B978-0-08-100888-1.00002-1>
- Doughty, D. H. (2012). *Vehicle Battery Safety Roadmap Guidance* [Technical Report] (NREL/SR-5400-54404). National Renewable Energy Laboratory. <https://www.osti.gov/biblio/1055366-vehicle-battery-safety-roadmap-guidance>
- Doughty, D. H., & Crafts, C. C. (2006). *FreedomCAR: Electrical Energy Storage System Abuse Test Manual for Electric and Hybrid Electric Vehicle Applications* [Technical Report] (SAND2005-3123). <https://www.osti.gov/servlets/purl/889934>
- Eastlake, H. W., & Blackwell, C. N. (2000). *Cost Estimating Software For General Aviation Aircraft Design* ASEE PEER 2000 Annual Conference, St. Louis, MO.
- Edwards, B. (2002). *Psycoacoustic Testing of Modulated Blade Spacing for Main Rotors* (NASA CR-2002-211651).
- European Commission, Joint Research Centre, Bielewski, M., Blagoeva, D., Cordella, M., Di Persio, F., Gaudillat, P., Hildebrand, S., Mancini, L., Mathieux, F., Moretto, P., Paffumi, E., Paraskevas, D., Ruiz, V., Sanf elix, J., Villanueva, A., & Zampori, L. (2021). *Analysis of sustainability criteria for lithium-ion batteries including related standards and regulations* [Technical Report] (JRC123925). Publications Office of the European Union. <https://op.europa.eu/en/publication-detail/-/publication/cb6b63eb-7268-11eb-9ac9-01aa75ed71a1/language-en>
- European Union Aviation Safety Agency. (2019). *Special Condition for Small-Category VTOL Aircraft* [Special Condition] (SC-VTOL-01, Issue 1). <https://www.easa.europa.eu/downloads/99956/en>
- European Union Aviation Safety Agency. (2020). *Proposed Means of Compliance with the Special Condition VTOL* (MOC SC-VTOL, Issue 1). <https://www.easa.europa.eu/downloads/114733/en>
- European Union Aviation Safety Agency. (2021a). *CRD Proposed Means of Compliance with the Special condition VTOL– MOC SC-VTOL Issue 1* [Comment Response Document]. <https://www.easa.europa.eu/downloads/114734/en>
- European Union Aviation Safety Agency. (2021b). *Means of Compliance with the Special Condition VTOL* (MOC SC-VTOL, Issue 2). <https://www.easa.europa.eu/downloads/127717/en>
- European Union Aviation Safety Agency. (2021c). *Second Publication of Proposed Means of Compliance with the Special Condition VTOL* (MOC-2 SC-VTOL, Issue 1). <https://www.easa.europa.eu/downloads/128938/en>
- European Union Aviation Safety Agency. (2021d). *Study on the societal acceptance of Urban Air Mobility in Europe*. <https://www.easa.europa.eu/full-report-study-societal-acceptance-urban-air-mobility-europe>
- European Union Aviation Safety Agency. (2022a). *CRD Proposed Means of Compliance with the Special condition VTOL– MOC-2 SC-VTOL Issue 1* [Comment Response Document]. <https://www.easa.europa.eu/downloads/136698/en>

- European Union Aviation Safety Agency. (2022b). *Second Publication of Proposed Means of Compliance with the Special Condition VTOL* (MOC-2 SC-VTOL, Issue 2). <https://www.easa.europa.eu/downloads/136697/en>
- European Union Aviation Safety Agency. (2022c). *Third Publication of Proposed Means of Compliance with the Special Condition VTOL* (MOC-3 SC-VTOL, Issue 1). <https://www.easa.europa.eu/downloads/136701/en>
- Federal Aviation Administration. (2005). *Type Certification - With Change 6*. (Order 8110.4C).
- Federal Aviation Administration. (2011). *14 CFR Part 36*. Dept. of Transportation, Federal Aviation Administration
- Federal Aviation Administration. (2017a). *Advisory Circular Noise Standards: Aircraft Type and Airworthiness Certification*. (AC 36-4D). U.S. Dept. of Transportation, Federal Aviation Administration
- Airworthiness Standards: Normal Category Airplanes, 14 CFR Part 23 Amdt. 23-64 (2017b). <https://www.ecfr.gov/current/title-14/chapter-I/subchapter-C/part-23?toc=1>
- Designation of applicable regulations, 14 CFR Part 21 § 21.17 Amdt. 21-100 (2017c). <https://www.ecfr.gov/current/title-14/chapter-I/subchapter-C/part-21#21.17>
- Federal Aviation Administration. (2017d). *FAA Accepted Means of Compliance Process for 14 CFR Part 23*. (AC 23.2010-1).
- Accepted Means of Compliance; Airworthiness Standards: Normal Category Airplanes, 14 CFR Part 23 87 FR 13911 (2022). <https://www.ecfr.gov/current/title-14/chapter-I/subchapter-C/part-23?toc=1>
- Federal Interagency Committee on Noise. (1992). *Federal Agency Review of Selected Airport Noise Analysis Issues*.
- Finger, D. F., Goetten, F., Braun, C., & Bil, C. (2019). *Cost Estimation Methods for Hybrid-Electric General Aviation Aircraft* Asia Pacific International Symposium on Aerospace Technology, Gold Coast, QLD, Australia.
- Frawley, G. (2003). *The International Directory of Civil Aircraft, 2003/2004*. Aerospace Publications Pty Ltd.
- Gasaway, D. C. (1969). *Noise Encountered in Rotary-Wing Aircraft*. U. S. o. A. Medicine.
- George, A. R., & Chou, S.-T. (1984). *Broadband Rotor Noise Analyses (NASA CR-3797)*.
- GlobalSecurity.org. (2005). *Advanced Missions Cost Model*. Retrieved April 19, 2022 from <https://www.globalsecurity.org/military/intro/reference/calc/AMCM.htm>
- Greenwood, E. (2011). *Fundamental Rotorcraft Acoustic Modeling from Experiments (FRAME)* [PhD Dissertation, University of Maryland].
- Greenwood, E. (2021). *Measurements to Support Noise Certification for UAS/UAM Vehicles and Identify Noise Reduction Opportunities Annual Report (ASCENT Project 077)*.
- Gudmundsson, S. (2014). *General Aviation Aircraft Design: Applied Methods and Procedures* (1st ed.). Elsevier Inc.
- Gunnarson, T. (2022, January 26th). ASTM Overview: eVTOL Standards. In TVF2022, 9th Annual Electric VTOL Symposium, San Jose, CA.
- H145 Technical Information*. Retrieved January 18, 2022 from <https://www.airbus.com/en/products-services/helicopters/civil-helicopters/h145/h145-technical-information>
- Hallez, R., Colangeli, C., Cuenca, J., & De Ryck, L. (2018). *Impact of electric propulsion on aircraft noise* 2018 AIAA/IEEE Electric Aircraft Technologies Symposium, Cincinnati, OH.

- Hayden, R. E., & Aravamudan, K. S. (1978). *Prediction and Reduction of Rotor Broadband Noise* International Specialists Symposium on Helicopter Acoustics, NASA Langley Research Center, Hampton, VA.
- Hess, R. W., & Romanoff, H. P. (1987a). *Aircraft Airframe Cost Estimating Relationships: All Mission Types* (N-2283/1-AF). The RAND Corporation.  
<https://www.rand.org/content/dam/rand/pubs/notes/2005/N2283.1.pdf>
- Hess, R. W., & Romanoff, H. P. (1987b). *Aircraft Airframe Cost Estimating Relationships: Study Approach and Conclusions* (R-3255-AF). The RAND Corporation.  
<https://www.rand.org/pubs/reports/R3255.html>
- Hirschberg, M. (2022). *The FAA makes a U-turn on its approach to powered-lift, as the eVTOL industry tries to hang on*. Retrieved Aug. 15th from <https://evtol.com/opinions/the-faa-makes-a-u-turn-on-its-approach-to-powered-lift-as-the-evtol-industry-tries-to-hang-on/>
- HondaJet Nears Final Type Certification*. (2015, April 12, 2019). AVweb. Retrieved April 25, 2022 from <https://www.avweb.com/recent-updates/business-military/hondajet-nears-final-type-certification/>
- Huff, D. L., Henderson, B. S., Cluts, J. D., Boyle, D. K., Bennett, J., & Janzen, J. (2021). *Noise Measurements from Ground Tests of the Moog SureFly Vehicle* AIAA Aviation 2021 Forum,
- International Civil Aviation Organization. (2017). *Annex 16 to the Convention on International Civil Aviation, Environmental Protection, Volume I, Aircraft Noise (8th Edition)*. Montreal, Canada: International Civil Aviation Organization
- International Civil Aviation Organization Committee on Aviation Environmental Protection. (2012). *Environmental Technical Manual Volume I: Procedures for the Noise Certification of Aircraft*.
- International Organization for Standardization. (2016). *Acoustics — Description, measurement and assessment of environmental noise — Part 1: Basic quantities and assessment procedures (ISO Standard No. 1996-1:2016)*. <https://www.iso.org/obp/ui/#iso:std:iso:1996:-1:ed-3:v1:en>
- Jones, H. W. (2015). *Estimating the Life Cycle Cost of Space Systems* 45th International Conference on Environmental Systems, Bellevue, WA.  
<https://ntrs.nasa.gov/api/citations/20160001190/downloads/20160001190.pdf>
- Kalnaus, S., Wang, H., Watkins, T., Simunovic, S., & Sengupta, A. (2019). Features of mechanical behavior of EV battery modules under high deformation rate. *Extreme Mechanics Letters*, 32, 100550. <https://doi.org/10.1016/j.eml.2019.100550>
- Kalnaus, S., Wang, Y., Li, J., Kumar, A., & Turner, J. A. (2018). Temperature and strain rate dependent behavior of polymer separator for Li-ion batteries. *Extreme Mechanics Letters*, 20, 73-80. <https://doi.org/https://doi.org/10.1016/j.eml.2018.01.006>
- King Air 360ER*. Retrieved January 19, 2022 from <https://beechcraft.txtav.com/en/king-air-360er>
- Kitaplioglu, C., & Shinoda, P. (1985). *Hover and Forward Flight Acoustics and Performance of a Small-Scale Helicopter Rotor System* (NASA TM-86786).
- Kotak, B., Kotak, Y., Brade, K., Kubjatko, T., & Schweiger, H.-G. (2021). Battery Crush Test Procedures in Standards and Regulation: Need for Augmentation and Harmonisation. *Batteries*, 7(3), 63. <https://www.mdpi.com/2313-0105/7/3/63>
- Krishnamurthy, S., Christian, A., & Rizzi, S. A. (2018). *Psychoacoustic Test to Determine Sound Quality Metric Indicators of Rotorcraft Noise Annoyance* 47th International Congress and Exposition on Noise Control Engineering, Chicago, Illinois.

- Larson, W. J., & Pranke, L. K., (Eds.). (1999). *Human Spaceflight: Mission Analysis and Design*. McGraw-Hill.
- Leitch, G. D. (2021, September 2021). Denali vs PC-12 NGX. *SA Flyer*, (308).  
[https://issuu.com/saflyermagazine/docs/saf\\_complete\\_21\\_09](https://issuu.com/saflyermagazine/docs/saf_complete_21_09)
- Lift Aircraft. (2021). *Frequently Asked Questions*. Retrieved August 8th from  
<https://www.liftaircraft.com/faq#:~:text=In%20the%20U.S.%2C%20Hexa%20is,for%20floats%20and%20safety%20equipment>
- Lukacs, M. D. (2009). *Estimating the Cost of Aircraft Development and Certification [White paper]*.
- Maisel, M. D., Giulianetti, D. J., & Dugan, D. C. (2000). *The History of the XV-15 Tilt Rotor Research Aircraft: From Concept to Flight* (NASA SP-2000-4517, Issue 17). National Aeronautics and Space Administration.
- Mestre, V., Fidell, S., Horonjeff, R. D., Schomer, P., Hastings, A., Tabachnick, B. G., & Schmitz, F. A. (2017). *Assessing Community Annoyance of Helicopter Noise*.  
<https://doi.org/10.17226/24948>
- Miller, N. P., Czech, J. J., Hellauer, K. M., Nicholas, B. L., Lohr, S., Jodts, E., Broene, P., Morganstein, D., Kali, J., Zhu, X., Cantor, D., Hudnall, J., & Melia, K. (2021). *Analysis of the Neighborhood Environmental Survey*. (DOT/FAA/TC-21/4). Federal Aviation Administration
- Mordor Intelligence. (2020). *Urban Air Mobility Market (2021 - 2035) [Presentation Slides]*. M. Intelligence.
- Mordor Intelligence. (2021). *Urban Air Mobility Market: Growth, Trends, COVID-19 Impact and Forecasts (2021-2035)*. <https://www.mordorintelligence.com/industry-reports/urban-air-mobility-uam-market>
- More, S. M. (2010). *Aircraft Noise Characteristics and Metrics* [Purdue University].
- Muller, J. (2015). *How The HondaJet Took Flight: An Engineer's 29-Year Obsession*. Forbes. Retrieved March 12, 2022 from  
<https://www.forbes.com/sites/joannmuller/2015/05/06/how-the-hondajet-took-flight-an-engineers-30-year-obsession/>
- Mulvaney, M., & Kratsios, M. (2017). FY 2019 Administration Research and Development Budget Priorities. In U.S. Department of the Treasury (Ed.).
- NASA. (1980). Bell XV-15 Tiltrotor. In.
- Ollerhead, J. B. (1982). *Laboratory Studies of Scales for Measuring Helicopter Noise (NASA-CR-3610)*.
- Orendorff, C. J., Lamb, J., & Steele, L. A. M. (2017). *Recommended Practices for Abuse Testing Rechargeable Energy Storage Systems (RESSs) [Technical Report]* (SAND2017-6925). Sandia National Laboratories. [https://www.sandia.gov/ess-ssl/wp-content/uploads/2019/05/SNL-Abuse-Testing-Manual\\_July2017\\_FINAL.pdf](https://www.sandia.gov/ess-ssl/wp-content/uploads/2019/05/SNL-Abuse-Testing-Manual_July2017_FINAL.pdf)
- Owens, A. d. W., Olivier. (2016). *Sensitivity Analysis of the Advanced Missions Cost Model* 46th International Conference on Environmental Systems, Vienna, Austria.
- Pascioni, K. A., Greenwood, E., Watts, M. E., Smith, C. D., & Stephenson, J. H. (2021). *Medium-Sized Helicopter Noise Abatement Flight Test Data (NASA TM-2021-0011459)*.
- Pascioni, K. A., Watts, M. E., Houston, M., Lind, A., Stephenson, J. H., & Bain, J. (2022). *Acoustic Flight Test of the Joby Aviation Advanced Air Mobility Prototype Vehicle* 28th AIAA/CEAS Aeroacoustics 2022 Conference,
- Peacock, L. (2020). *Jane's All the World's Aircraft: Development and Production 2020-2021* (P. Jackson, Ed. 108th edition ed.). Jane's by IHS Markit.

- Rajala, V., & Hongisto, V. (2020). Annoyance penalty of impulsive noise – The effect of impulse onset. *Building and Environment*, 168. <https://doi.org/10.1016/j.buildenv.2019.106539>
- Riley, T., & Cuppoletti, D. R. (2021). *Acoustic Analysis Framework for Prediction of UAM Noise Radiation from Subscale Data* AIAA Scitech 2021 Forum,
- Rizzi, S. A., Huff, D. L., Boyd, D. D., Jr., Bent, P., Henderson, B. S., Pascioni, K. A., Sargent, D. C., Josephson, D. L., Marsan, M., He, H. B., & Snider, R. (2020). *Urban Air Mobility Noise: Current Practice, Gaps, and Recommendations* [Technical Publication (TP)] (NASA/TP-2020-5007433). <https://ntrs.nasa.gov/citations/20205007433>
- Roth, M. (2000). Review of atmospheric turbulence over cities. *Quarterly Journal of the Royal Meteorological Society*, 126(564), 941–990. <https://doi.org/10.1002/qj.49712656409>
- RTCA. (2017). *Minimum Operational Performance Standards for Rechargeable Lithium Batteries and Battery Systems*. (DO-311A).
- Sabrewing Aircraft Company. *Rhaegal RG-1*. Retrieved February 28th from <https://www.sabrewingaircraft.com/cargo-uav/#:~:text=Rhaegal%20RG%20D1,of%20200%20knots%20%2F%20370%20kph>.
- SAE International. (2013). *Safety Standard for Electric and Hybrid Vehicle Propulsion Battery Systems Utilizing Lithium-based Rechargeable Cells*. (SAE Standard J2929).
- SAE International. (2021). *Electric and Hybrid Electric Vehicle Rechargeable Energy Storage System (RESS) Safety and Abuse Testing*. (SAE Standard J2464).
- Schildt, P., Braun, C., & Marcocca, P. (2017). *Flight Testing the Extra 330LE Flying Testbed* 2017 Society of Flight Test Engineers Symposium, Destin, FL.
- Schultz, T. J. (1978). Synthesis of social surveys on noise annoyance. *J Acoust Soc Am*, 64(2), 377-405.
- Senzig, D. A., & Marsan, M. (2018). *UAS noise certification* INTER-NOISE 2018, Chicago, Illinois.
- Shenoy, R. K., Kohlhepp, F. W., & Leighton, K. P. (1986). *Acoustic Characteristics of 1/20-Scale Model Helicopter Rotors*. <https://ntrs.nasa.gov/api/citations/19880014164/downloads/19880014164.pdf>
- SMG Consulting LLC. (2022). *Advanced Air Mobility Reality Index*. Retrieved March 8th from <https://aamrealityindex.com/aam-reality-index>
- Smith, B., Gandhi, F., & Niemiec, R. (2020). *A Comparison of Multicopter Noise Characteristics with Increasing Number of Rotors* Vertical Flight Society's 76th Annual Forum & Technology Display, Virginia Beach, VA.
- Thipphavong, D. P., Apaza, R. D., Barmore, B. E., Battiste, V., Burian, B. K., Dao, Q. V., Feary, M. S., Go, S., Goodrich, K. H., Homola, J. R., Idris, H. R., Kopardekar, P. H., Lachter, J. B., Neogi, N. A., Ng, H. K., Oseguera-Lohr, R. M., Patterson, M. D., & Verma, S. A. (2018). *Urban Air Mobility Airspace Integration Concepts and Considerations* Aviation Technology, Integration, and Operations Convergence.,
- Thompson, S. (2018). Part 23 Amendment 64: A Performance-Based Approach to Type Certification of Small Airplanes. DGAC 6th Annual Seminar on Safety in Airworthiness, Santa Cruz, Bolivia.
- Tilt Rotor Project. (1975). *Tilt Rotor Research Aircraft Familiarization Document (NASA-TM-X-62407)*.
- Torija, A. J., Chaitanya, P., & Li, Z. (2021). Psychoacoustic analysis of contra-rotating propeller noise for unmanned aerial vehicles. *J Acoust Soc Am*, 149(2), 835. <https://doi.org/10.1121/10.0003432>



- Uber Elevate. (2016). *Fast-Forwarding to a Future of On-Demand Urban Air Transportation [White Paper]*.
- United Nations. (2019). *Manual of Tests and Criteria - Seventh Revised Edition [ST/SG/AC.10/11/Rev.7]*. United Nations,.  
<https://doi.org/https://doi.org/10.18356/390e2d1a-en>
- Wang, Z., Henricks, Q., Zhuang, M., Pandey, A., Sutkowy, M., Harter, B., McCrink, M., & Gregory, J. (2019). Impact of Rotor–Airframe Orientation on the Aerodynamic and Aeroacoustic Characteristics of Small Unmanned Aerial Systems. *Drones*, 3(3).  
<https://doi.org/10.3390/drones3030056>
- Watts, M. E., Greenwood, E., Smith, C. D., & Stephenson, J. H. (2019). *Noise Abatement Flight Test Data Report (NASA TM-2019-220264)*.
- World Health Organization. (2018). *Environmental Noise Guidelines for the European Region*. W. H. Organization.
- Yi, X., Zhang, Z., Li, Z., He, Y., & Liu, Q. (2019, 18-20 Oct. 2019). Effect of State of Charge on Thermal Runaway Characteristics of 18650 Lithium Ion Batteries. 2019 9th International Conference on Fire Science and Fire Protection Engineering (ICFSFPE),
- Zawodny, N. S., & Boyd, D. D., Jr. (2017). *Investigation of Rotor-Airframe Interaction Noise Associated with Small-Scale Rotary-Wing Unmanned Aircraft Systems* AHS International 73rd Annual Forum & Technology Display, Fort Worth, TX.
- Zhou, W., Ning, Z., Li, H., & Hu, H. (2017). *An Experimental Investigation on Rotor-to-Rotor Interactions of Small UAV Propellers* 35th AIAA Applied Aerodynamics Conference,
- Zwicker, E., & Fastl, H. (1999). *Psychoacoustics: Facts and Models* (2nd ed.). Springer-Verlag.

### 3.6 Appendix A: EVTOL Database

A database of the entire UAM VTOL market was generated, where the main characteristics of 212 vehicles were documented. The vehicles included in this database were extracted from the eVTOL Aircraft Directory available at [evtol.news/aircraft](http://evtol.news/aircraft). The generated database excludes any aircraft that does not fit the Rizzi definition of a UAM vehicle (Rizzi et al., 2020), is defunct, does not have any technical information, or was added after June 2021, which was the most recent update of the database at the time of writing this report.

The final version of the database in excel format can be found attached to this document.



2021-06-07\_VTOL\_List\_NoCTOL\_DATABASE

## 4 EVALUATION OF UAM INTEGRATION ON THE NATIONAL AEROSPACE SYSTEM – AIR TRAFFIC CONTROL AND OPERATIONS

### 4.1 Introduction

Urban Air Mobility (UAM) and Advanced Air Mobility (AAM) are the two newly introduced concepts to be added as a new form of transportation within urban and other areas. To enable their integration within the transportation networks of our urban environments, the UAM ecosystem must achieve compatibility with the National Airspace System (NAS) and other novel Air Traffic Management (ATM) environments, such as Unmanned Aircraft System (UAS) Traffic Management (UTM). Work package 3 of the ASSURE A36 project (WP3) seeks to identify the impact of UAM on the NAS with respect to Air Traffic Control (ATC), infrastructure, and operations via introduction of common terms and definitions, research gaps that exist for a successful integration, as well as certain assumptions and limitations that are imposed on this research study.

#### 4.1.1 Introduction of common terms and their definitions

With the multitude of related systems and associated acronyms, this section assists in definition of the four fundamental terms:

- **Unmanned Aircraft System Traffic Management (UTM)** is a traffic management system complementary to ATM that identifies services, responsibilities, architecture, data exchange practices, performance, etc., for low altitude sUAS operations.
- **Urban Air Mobility (UAM)** is a transportation system or a set thereof that will work on transitioning from the current ATM system to autonomous aircraft serving low-level altitudes within the urban environments.
- **Advanced Air Mobility (AAM)** is an initiative by National Aeronautics and Space Administration (NASA), FAA, and other aviation industry stakeholders that builds upon UAM concept to develop a transportation system for transporting people and cargo between local, regional, intraregional, and other areas that currently receive little to no aviation services and are not specific to urban environments.
- **On-Demand Mobility (ODM)** is very similar to UAM, where automated, electric-powered aircraft provide high-speed on-demand transportation services to the public. In the context of this study, ODM and UAM are used interchangeably without any specific distinction in provided services or principles of operations.

#### 4.1.2 Introduction of UAM CONOPs

There are currently two existing Concepts of Operations (CONOPs), one presented by the FAA (2021a) and one by NASA (Hill et al., 2020). Both CONOPs describe an operational environment that will support the growth of UAM operations in and around densely populated urban areas in the United States. Their goal is to develop an air transportation system within major urban centers and between regions that will allow a safe and gradual transition from traditional ATM to a system that incorporates low-altitude operations of manned and autonomous aircraft operations within those environments. This system will be able to sustain hundreds of simultaneous low-altitude UAM operations.

While both CONOPs describe a similar UAM operating environment, their application and organization of airspace structure is different. NASA defines a UAM Operational Environment (UOE) with a free-flight concept. FAA ConOps 1.0 Operations (3.2) envisions established corridors with UAM flights adhering to paths solely within those structures for nominal scenarios, but mature state operations will drive less structure and more fluid operations. Another main difference between the two is in the scale of initial implementation. The FAA's initial goal for UAM incorporation into the National Airspace System (NAS) is to use current operational blueprint and infrastructure, such as helicopter routes and helipads as a template for further development of UAM airspace design. NASA is aiming to reach pre-defined UAM Maturity Level (UML) 4 within the same time span. However, it entails hundreds of UAM operations with reduced separation requirements and in low-visibility conditions, which is far more advanced than the FAA's vision. Other differences between concepts of operations are in operational assumptions, specifics relative to the regulations and aircraft certification, vertiport vs. airport definitions, etc.

#### **4.1.3 Research Gaps**

The research team identified the following research gaps from the literature review, industry analysis, and industry development projections. These gaps include open questions posed by the UAM community and gaps identified by the A36 team.

- What are the operational constraints of UAM corridors?
- What are the operational constraints of UAM vertiports?
- What minimal Communication, Navigation, and Surveillance (CNS) requirements are necessary to achieve non-segregated UAM operations?
- What are the roles and responsibilities of the Providers of UAM Service (PSU) vs. ATC with respect to UAM flight planning, surveillance, information exchange, deconfliction, and contingency management?
- What data exchange must be supported by ATC with UAM stakeholders?
- What UAM system characteristics, infrastructure, and operational requirements influence ATC workload?
- What best practices can be established to guide vertiport design and planning?
- How can multi-modal transportation network simulation enable future UAM research?

#### **4.1.4 Assumptions and Limitations**

The team identified several assumptions that may be applied to the scope of this study and overall outcomes. Certain limitations have also been recognized to have a possible impact on the scope of the study.

- The study shall implement UAM operational scenario simulations modeling operations within the vicinity of Daytona Beach International Airport (KDAB) to leverage existing resources and local ATC Subject Matter Experts (SMEs) with extensive past or ongoing experience in KDAB tower.
- The results of this simulation can be applied to most airports around the US.
  - The exact application will depend on runway configuration, number of available runways, availability of infrastructure resources, availability of ATC radar equipment, active Standard Operating Procedures (SOPs) and Letters of Agreement (LOAs), airspace structure and configuration, annual weather patterns and phenomena, geographical location, etc.

- The level of simulated capabilities does not exceed the operational tempo of the FAA CONOPs 1.0 Operations or NASA UML-4 Stage of UAM development.
  - Using the FAA CONOPs 1.0 as a foundation, simulated environment combined assumptions from both FAA CONOPs 1.0 or NASA Vision CONOPs UML-4 that were most compatible with the team’s vision of the procedural requirements and standards.
  - The capabilities and operational assumptions tested do not exceed those described in the FAA CONOPs 1.0 or NASA Vision CONOPs UML-4.
    - i. The participants for the experiment should be familiar with the ATCT environment and have prior training within that environment before the start of the experiment.
    - ii. The skill and experience of the participants may vary due to the level of training they have achieved to date or whether they were exposed to the real-life ATC environment.
    - iii. As this study proposes multiple runs of the experiment scenarios (within-subjects design), some of the confounding variables, like order effect or maturation, may affect the study results.
- The FAA support includes internal information from UAM stakeholders to support current and future attempts for generation of expectations on required capabilities and standards envisioned for UAM operations.

## 4.2 Research Questions

This research study has investigated the impact of UAM on the NAS as new operations are integrated into both traditional ATM systems and their procedures, and/or into the UTM framework. Research questions addressed within this study include:

- What timelines for UAM/AAM capabilities are proposed by academia, industry, government, or other relevant stakeholders?
- What are the minimum system, operational, and procedural requirements necessary to enable UAM integration?
- What CNS requirements/best practices are necessary for UAM integration?
- What is the impact of UAM integration on air traffic controller workload?
- What are the infrastructural requirements necessary to support UAM integration into NAS (including terminal environments)?
- What strategies exist to coordinate non-segregated operations between the UAM and non-UAM air traffic?
- What are recent industry advancements toward UAM integration globally?
- What factors influence vertiport infrastructure design and planning?

## 4.3 Summary of Literature Review

The research team surveyed over 130 articles with 105 cited in Appendix A of this report. Articles were organized by the research questions they inform, where some of them often addressed multiple research questions. The team reviewed articles, capturing information that addresses each research question either partially or in full. These notes with citations were organized into the report’s

narrative that attempts to explain the current state-of-the-art technologies and trends toward future development for each question. The following section provides a summary of the key findings for each research question.

#### ***4.3.1 Proposed Timeline of AAM Development and Integration***

As UTM and UAM emerge as new airspace concepts whose growth depends upon advances in technologies and markets, this section surveys the anticipated timelines of their maturity and implementation. The European Union Aviation Safety Agency (EASA) (2021) indicated that all 76 analyzed publications chosen for their UAM study were published no earlier than 2017, showing a significant interest in the topic in recent years. While EASA does not have an exact year for UTM and UAM's market entry, most of their sources point to 2025 for market entry and 2030 for autonomous operations.

Dietrich (2020b) and Mendonca (2020) analyzed the growth opportunities for AAM and UAM in the upcoming decades. Using NASA's UMLs, UAM growth was projected to be gradual with different key factors, like automation, infrastructure, etc., developing simultaneously over the next decade. Both studies expect UAM to reach its full potential around 2030 and to continue maturation from 2030 and onward. Lineberger et al. (2021) project a similar timeline of events based on a recent AAM industry development analysis. The main difference between the projections is a significant slow-down of industry growth after the first two decades of implementation. The UK Research and Innovation (UKRI) (2021) presents a program for UAM growth divided into five main stages spanning over the same projected timeline. Despite slight differences in their time frame proposals, Dietrich (2020b), Mendonca (2020), Lineberger et al. (2021), and UKRI (2021) all agree that the UAM industry will reach maturity in the 2030s.

Hasan (2019) conducted a market study on the viability of UAM for last-mile delivery, air-metro, and air-taxi within the next decade. The analysis projected the first profitable year of last-mile delivery would not occur earlier than 2030. In retrospect, air-metro is anticipated to start earning profits in 2028 at 130 million trips with continual growth into 2030 with 740 million expected operations. The most impactful variables are certification, number of vertiports, maintenance and energy costs, limited passenger capacities, and vehicle supply. The air-taxi service is not projected to be profitable within the next decade, but it is expected to have demand in urban areas like Miami, New York City, San Francisco, etc.

#### ***4.3.2 Minimum System, Operational, and Procedural Requirements Necessary to Enable UAM Integration***

This section identifies the minimum requirements to enable integration for UAM systems, operations, and procedures. It first addresses literature regarding UTM and NAS constraints. Next, it explores altitudes, velocities, and automation. Finally, this section discusses the regulatory considerations identified through the literature.

##### **4.3.2.1 UAM Traffic Management Framework Constraints**

As a new entrant to NAS, UAM is projected to utilize significant chunks of pre-defined airspace, similarly to sUAS. UAM operations are expected to use a similar (or the same) structure for progressive and effective flight management, just like UTM under 400 ft. Same as ATM, a concept

of UOE covers all UAM operations in low-level airspace with consideration for various NAS constraints.

Hill et al. (2020), Patterson et al. (2021), and Volocopter (2021) explained that the basic architecture of the UOE should be like that of the current UTM infrastructure plan, in which third-party federated service suppliers are in the scope of PSUs. This environment shall be the size of horizontal airspace between the top of UTM airspace and the bottom of regular controlled air traffic airspace. Within the UOE, the number of PSUs managing traffic may vary. Hill et al. (2020) and Patterson et al. (2021) outlined that, depending on the size of the UOE, single or multiple PSU may manage the whole UOE or its sectors. It should be flexible as the portions of the operating area would be deemed “available” or “not available” based on factors like temporary flight restrictions, non-UAM users' needs, traffic demand, etc.

Since the route structure should be organized as a network, Zhu and Wei (2019) described two options for its layout. Option one is a locally connected network with only certain aerodromes being inter-connected. It is simple with fewer collision points; however, some flights may not have direct routing. Option two is a densely connected route network with direct paths between all aerodromes accessible to that environment. Despite the direct routing, safety hazard risk is higher with more collision points.

Data sharing for UTM aircraft ensures that all stakeholders are informed of UTM operations. The National Aeronautics and Space Administration (NASA), in partnership with the Federal Aviation Administration (FAA), is well positioned to lead the industry in defining and establishing a new, third set of flight rules for NAS users that will unify the approach to achieving the diverse mobility needs of current and emerging operations. Augmenting but not replacing VFR and IFR, the new flight rules – which we refer to as Digital Flight Rules (DFR) – will provide all operators, current and future, the opportunity to achieve unprecedented mobility. DFR will offer ubiquitous access to all airspace classes in both Visual Meteorological Conditions (VMC) and Instrument Meteorological Conditions (IMC) and unmatched flexibility of operations to meet the wide diversity of operational needs at scale. David and Ian (2020) explained that the objective of DFR is to provide safe and unfettered access to the airspace to all participating vehicle operators under all visibility conditions without incurring the limitations in operational flexibility inherent to IFR and even VFR. Advancements in communications, navigation, surveillance, aircraft connectivity, information access, automation technology, and supporting ground infrastructure provide the opportunity for the vehicle operator to engage at an unprecedented level in managing their flights regardless of flight visibility. Under DFR, these advancements enable the vehicle operator to assume full responsibility for traffic separation and therefore full trajectory management authority in all visibility conditions and airspace regions. According to Volf (2017), Mueller et al. (2017), Ramasamy et al. (2017), Raju et al. (2018), Sacharny et al. (2020), and Rollo et al. (2017), UAS operators shall send operational intents and real-time information to UTM Service Suppliers (USSs). The USS would then share primary constraints to public safety agencies, along with operational constraints, modifications, notifications, and other information. The data would also be exchanged with System Wide Information Management and supplemental data suppliers to include terrain, weather, surveillance, and performance information. The USS would define UAS mission constraints, operation boundaries, performance requirements, and distribution of no-fly zones, Notices to Airmen, weather, etc.

#### **4.3.2.2 NAS Constraints**

Comparing NAS constraints and UAM challenges, Vascik et al. (2018b) and Morgan Stanley Research (2021) identified NAS-dependent challenges that include weather restrictions, access to controlled airspace, autonomy interactions with ATC, and safety in congested flight areas. The main UAM impacts from these constraints were found to be on ATC scalability, all-weather operations, and network operations.

As with any other new entrant, many assumptions have been applied to maintain efficiency of the operations for all users. FAA (2020a) assumes any developments of regulatory, operational, or technical background to satisfy safety concerns that may arise. In addition, UAM aircraft are expected to operate within the environment identified within NAS yet separated from other NAS users. UAM will have established corridor networks that allow safe passage for aircraft operationally separated from other NAS users. The data would be shared via FAA-NAS data exchange protocols to ensure clear connection and communication between the FAA and UAM community.

The ATC element, as a limiting human factor within the NAS structure, is one of the fastest variables to reach capacity. Vascik and Hansman (2017) identified that much of the airspace in Los Angeles and other major urban areas is not utilized for commercial operations, general aviation, or helicopters. It may be used for upscale ODM operations without having any impact on the NAS. In Vascik and Hansman (2020), the authors proposed the use of static and dynamic cutouts for airspace allocation to provide procedural separation to all air traffic based on the airspace usage and traffic flow patterns. The cutout availability will be defined by the ATC, but the operations within that airspace will not be under their control. Using the proposed concept has increased UAM accessibility by 80% without imposing extra workload on ATM infrastructure.

Mueller et al. (2017) recognized airspace capacity as a dynamic value and proposed that a mix of corridors and traffic flow management should be established to allow predictability and separation of operations. Even though the FAA has full authority over NAS activities, Patterson et al. (2021) predicts that it will delegate many responsibilities and functions to PSUs. Therefore, if the UAM aircraft stay within its designated UOE boundaries or corridors, they will be managed by UOE/Corridor stakeholders, i.e., PSUs, with minimal (if any) pressure on the ATC system.

Booz Allen Hamilton (2018a, 2018b) analyzed weather patterns in specific urban areas of interest to evaluate the barriers it may impose on UAM operations. The results showed significantly different weather patterns between various areas within the urban environment and between surface and aloft altitudes. Looking at results by geographic locations, weather patterns on the west coast are generally more favorable for UAM flights than in the central US or east coast.

#### **4.3.2.3 Altitudes**

UAM flight operations depend upon the identification of viable altitudes to ensure safety of the UAM aircraft and other airspace users. A Booz Allen Hamilton (2018a) study considers a range of operational altitudes for UAM between 500 and 5,000 ft. The authors justified this range by their weather analysis and strong winds aloft at altitudes above 5,000 ft in the cities of focus. Chan et al. (2018) predicts that the initial UAM operations are expected to start in low-level airspace below 2,000 ft. Once all major characteristics of UAM operations are identified (i.e., services, procedures, support tools, etc.), such aircraft can be integrated at higher altitudes. Lascara et al. (2019) states that most operators expect the operating altitudes to be at or below 5,000 ft over metropolitan areas. sUAS



as part of UTM operations will generally be bound to altitudes below 400 ft. Although, in their airspace integration concept, UAM aircraft flew through UTM corridors allocated under 2,000 ft (at around 1,700 ft).

#### **4.3.2.4 Velocities**

Surveyed literature addressed the speeds flown relative to flight profile. Kotwicz et al. (2019) found that current electric aircraft with a range of up to 50 NM are most feasible with flight profile speeds of up to 150 kts. However, the continuous advancement of battery technology projects electric aircraft's distance and speed capabilities to increase in the future. Both Niklaß et al. (2020) and Zapico et al. (2021) proposed speeds for different flight profiles depending on the environment. Standard vertical speeds were 500 ft/min for take-off and 300 ft/min for landing. Approach and departure speeds were 500 ft/min vertical and 45 to 130 kts horizontally (variations based on the environment landscape). Cruise speeds in all situations were 130 kts. Stall speed was identified to be 73 kts.

#### **4.3.2.5 Automation**

The use of automation for UAM remains a controversial topic within the AAM community. Volocopter (2021) predicts a gradual introduction as the operations expand. By eliminating the flight crew, UAM will become more affordable, safer, and have a greater opportunity for expansion within the industry. Without automation, as the number of aircraft increases, pilot workload would also increase, especially in unpredictable environments (e.g., urban airspace).

The human element or the absence thereof must be considered as it can be both beneficial and/or a challenge. Loon (2020) asserts a human on the loop must remain an element of aircraft operations, regardless of the level of aircraft automation. While automation systems shall create and perform flight plans, human supervisors will analyze irregularities and arrange limits and priorities for automated aircraft to enhance safety. Aircraft automation would reduce human pilot fatigue and error, which also decreases the chance of accidents. Nevertheless, the UAM's software applications can assist in avoiding potential conflicts as human limitations may impact situational awareness.

In 2017, WISK became the first company in the U.S. to successfully fly an autonomous, eVTOL aircraft designed for passenger use. Since then, they've remained committed to a self-flying first approach and the safe integration of autonomous aircraft systems into existing airspace. Through partnerships with other aviation leaders, like NASA, they're creating autonomous flight-based solutions that address the growing urban mobility crisis in a way that is effective, accessible, and sustainable. The WISK's 6<sup>th</sup> generation aircraft is designed for Urban Air Mobility with main mission of Air Taxi. It comes with all-electric power and the aircraft classification is eVTOL. The aircraft type is still at an experimental level but expected to have fixed wings, on a single propeller, an autonomous (self-flying) pilot type and an altitude range from 1500-5000 AGL. The dimensions will be 21 feet long with 36-foot wingspan. It will come with 12 independent lift fans and fly initially about 25 miles plus reserves/ 40 kilometers plus reserves. The aircraft speed will be about 100 miles per hour/160 kilometers per hour. Pioneering an entirely new way to fly, the all-electric, self-flying air taxi rises like a helicopter and flies like a plane. The eVTOL aircraft will remove the need for a runway and allow people to land where they need to be. By using self-flying software combined with human oversight, WISK is shaping the future of accessible, everyday flight.

Despite the literature largely reporting automation as a UAM enabler, the survey identified some issues worthy of consideration. The National Academies of Sciences, Engineering, and Medicine (2020) state that automated aircraft systems must go through rigorous testing in low-risk environments before larger-scale implementation to prevent disruptions from common safety issues associated with automation. While the current advancements within NAS did not anticipate greater levels of automation in use, new automation-tailored operations and procedures can enable an easier integration of automated aircraft systems. Aircraft separation represents one capability significantly lacking within UAM automation due to the absence of suitable Detect-And-Avoid (DAA) technologies. The Federal Aviation Administration's (FAA) objective was also supported by RCTA committee with the establishment of SC-228, Minimum Performance Standards for Unmanned Aircraft Systems, on May 20, 2013. The committee's goals include creating Guidance Material (GM) for Navigation Systems, Lost Link UAS Behavior (GM), Minimum Aviation System Performance Standards (MASPS) for Command and Control (C2) Data Link Systems, and Minimum Operational Performance Standards (MOPS) for Detect and Avoid (DAA) equipment. The first round of standards development concentrated on civil UAS capable of entering Class A airspace and operating under IFR flight regulations. The transfer of a UAS from Class A or special use airspace and via Class C, D, E, and G airspace is now part of the operational environment for the DAA MOPS. The committee devised a C-Band solution when creating the performance specifications for the C2 Data Link. Along with EUROCAE WG-105, the committee also takes into account newly licensed bands that are made accessible for C2 Links, including cellular networks. With the introduction of DO-362, Command and Control (C2) Data Link Minimum Operational Performance Standards (MOPS), the committee's first documents were published in September 2016. (Terrestrial). Through 2023, additional work is anticipated to be completed.

#### **4.3.2.6 Regulations**

As the AAM domain is an emerging concept, there are no regulatory requirements currently set for UAM operations. Multiple studies, including Hill et al. (2020), Hasan (2019), and Hall (2020), state that the FAA will be the primary federal regulator of UAM operations, as its main goal is to ensure aviation safety. While the FAA remains the regulatory and operational authority, PSUs would maintain the responsibility for delivering flight-planning services, communications, and separation, among other data elements. These studies, as well as Lineberger (2021), agreed that some regulations may need to be created or modified to accommodate UAM limitations and spacing/separation needs. In addition, Hasan (2019) explained that air metro and air taxi operations are closely paralleled by regulations covering rotorcraft. Adding electric propulsion and autonomy to the NAS would require countless modifications within existing regulations, as well as the need to introduce new regulations to govern these aircraft and procedures.

The main regulatory piece assumed to serve as the foundation for UTM and UAM operations is 14 Code of Federal Regulation (CFR) Part 89. According to the FAA (2020b), Part 89 Remote Identification of Unmanned Aircraft (Remote ID) is a regulation that requires all UAS to broadcast certain information. The FAA explains that Remote ID is necessary to address aviation safety and security issues regarding UAS operators, as it is an essential building block toward safely allowing more complex UAS operations. All UAS aircraft are required to comply with Part 89, and sUAS aircraft are only required to conform to Part 89 if operating under Part 107. However, it is not clear how remote ID implementation, which will affect sUAS, will affect AAMs. AAMs will likely fly

under Part 135 (or some closely related rules) and will be identified based on their on-board digital IDs (either through DFRs or through some other on-flight IDs) as discussed below under CNS.

### ***4.3.3 Communication, Navigation, and Surveillance Requirements and Best Practices for UAM Integration***

This section defines the CNS requirements and best practices necessary to achieve UAM integration.

#### **4.3.3.1 Communications**

Of CNS-related subsystems, communication systems have great diversity when considering the number of stakeholders, types of communication required to enable UAM, and the architecture of the communication system(s) for the UAM operating environment and the aircraft. Raju et al. (2018) analyzed Flight Information Management System (FIMS), where USS can report intentions, messages, and locations and receive notifications about UTM airspace and operations. Similarly described in Hill (2020), this system allows UAM to operate without ATC clearance but enables ATC communications in case of deviations from authorized procedures. In addition, Lascara et al. (2019) foresees that UAM aircraft should be able to communicate vital safety procedures, which include traffic location, Dynamic Delegated Corridors (DDC) updates, weather data, obstacles, flight paths, and destination information. For this reason, FIMS within the UTM system might be used as the main application for data sharing between different stakeholders.

FAA (2020a) states that while PSUs are the primary communication method for UAM operators, ATC can communicate with the UAM community when it doesn't increase their workload. This communication has two aspects: strategic (e.g., flight planning) and tactical (i.e., diversion). While ATC communications for the former can be done via PSUs (and share intent with others), tactical communications are likely to be directly between ATC and the AAM A/C. When working with UAM aircraft, ATC can set corridor availability, give updates about UAM procedures, acknowledge abnormal UAM performances, and review data from UAM procedures. Young et al. (2020) project UAM communications to utilize information-upon-request type design, where operators would request the most up-to-date information from service providers before the flight. UAM Pilot in Command (PIC) would have minimal conversations with service providers during the flight and mainly use the UAM aircraft's systems to convey data to the service provider.

#### **4.3.3.2 Navigation**

The navigation aspect of the CNS systems is fundamental for the definition of operational environments, airspace throughput, and UAM aircraft navigational requirements. Mueller et al. (2017) state that to meet advanced navigational performance for UAM operations, the aircraft are likely to be equipped with a Wide Area Augmentation System (WAAS)-enabled Global Positioning System (GPS). Lascara et al. (2019) explain that performance-based operations are essential for UAM flights within corridors and the UTM/UTM-like network in general. Since access to a corridor requires a certain level of navigational precision, better operational performance permits more direct routing and a wider variety of corridor options for UAM aircraft.

Cotton (2020) and Stouffer et al. (2020) explain that because Global Navigation Satellite System (GNSS) is not as reliable in urban environments, a multiple-sensor fusion system with three or more sensors might be necessary for more advanced precision levels of navigation for UAM aircraft. Cotton (2020) argues that GNSS fused with Electro-Optical and Infrared (EO/IR) sensors would improve precision during the departure, approach, and landing phases of flight. However, as

operational volumes scale up, Low Area Augmentation System (LAAS) and WAAS are expected to provide even greater precision for navigation in low-level airspace. As helicopter operations are closely related to UAM, it is important to explore current Required Navigation Performance (RNP) requirements set via Advisory Circular (AC) 90-105A for these operations. According to FAA (2016), RNP 0.3 provides a sufficient level of safety and performance for rotorcraft operations in en-route and terminal environments.

#### **4.3.3.3 Surveillance**

As UAM aircraft conduct flight operations at low altitudes and compact urban environments, surveillance has shown to be a crucial factor within CNS architecture. According to Hill (2020), UTM surveillance should be conducted by a set of ground, aircraft-borne, and satellite-based infrastructure. It would be mostly sustained by the PSUs, but precise monitoring might be enhanced by aircraft-to-aircraft or ground-to-aircraft surveillance technologies. Similarly, FAA (2020a) describes surveillance features where most of the data exchange happens within PSU networks shared with USSs, Supplemental Data Service Provider (SDSPs), the FAA, and other stakeholders with access. Surveillance of UAM aircraft within corridors uses data sharing of operational intent, Remote ID, and supplemental information between those entities but without any ATC involvement. While UAM operations are not envisioned to use Automatic Dependent Surveillance – Broadcast (ADS-B) Out or transponders during nominal operations, if contingency occurs, UAM pilots are expected to turn on the transponder if departing its assigned corridor.

FAA (2020b) proposes the idea of using Remote IDs to achieve safety and security during UAS integration into NAS. Remote ID can be pre-installed on an aircraft to broadcast identification, location, altitude, velocity, etc., constantly, or added onto the aircraft to transmit the information with a condition of line-of-sight. Liu et al. (2021) explain that due to the nature of both environments and the design of unmanned operations, the Remote ID element will be a crucial part of UAS surveillance as it aids with issues like upload rate, range, accuracy, etc., that influence the quality and reliability of operation in an ATC controlled environment. Based on their research, surveillance can be conducted via broadcasting to the nearest ATC station using ADS-B, radio frequency, and similar means. ATC will need procedures to limit displaying these aircraft on FAA RADAR displays. This can be done today with the STARS equipment, using SQUAWK code blocks, altitudes, and other means. Further research should be done in this area.

On the other hand, Cotton (2020) predicts that ADS-B, as one of the primary surveillance methods today, will get overcrowded if UAM uses it for their operations, even at higher altitudes. They also explain that surveillance in urban environments requires either many receiving sites or high-power transmissions from UAM due to the operational environment and high RF reflectivity from the buildings. As the study does not consider the UTM concept but that the UAM will be non-segregated from air traffic, ADS-B with low-power Traffic Collision Avoidance System (TCAS) might suffice in Class B airspace. As there are no requirements for cooperative surveillance in Class E and Class G airspaces, radar and sensor systems will suffice to uphold DAA techniques.

#### **Expansion of CNS**

While considering UAM communications, it is vital to highlight V2V communications as a potential network topology. Volf (2017) described V2V and Inter-USS communications, highlighting the issues of UAS integration related to communications. V2V communications should satisfy flight

coordination, DAA, and collision avoidance to ensure safe and reliable operation. Inter-USS communication replicates handover procedures like the current ATC system, as well as it regulates the ATC workload. However, some of the outlined issues were the unknown extent of Pilot-ATC communications and the quality of the C2 data link. Mueller et al. (2017) argue that sophisticated communication methods will reduce aircraft's need for sensors, algorithms, displays, and other flight hardware, except for backup systems. Robust interaction designs will also allow improved aircraft supervision and operation automation wherever necessary. Emerging V2V communications shall enable communication of a better operating picture for an aircraft's flight path and intent via data sharing to other aircraft operating in the airspace.

Once the system can support a variety of navigational means, UAM aircraft need to have specific navigational equipment onboard the aircraft to maintain high accuracy. Hill (2020) recognizes that UAM aircraft shall be capable of navigation using precise Performance-Based Navigation (PBN) capabilities to support flights in non-VMC conditions. An external data feed and onboard hardware, software, etc., will enable these capabilities. More stringent requirements for UAM PBN are predicated by obstacle avoidance, conformance to the routing, and emergency scenarios. A UAM PBN method would also be beneficial for take-off and landing procedures, as the crews would not need to be educated on multiple options of approaches (e.g., Localizer or Area Navigation (RNAV)).

Looking further into on-board surveillance options, Guan et al. (2020) compared different types of cooperative and non-cooperative surveillance. ADS-B has the highest detection range providing location, altitude, and speed, and being capable of tracking and communication. Traffic Collision Avoidance System (TCAS)/Airborne Collision Avoidance System – X (ACAS-X) has a high detection range providing distance and altitude, but its weight limits feasibility for UAS (potentially suitable for a larger UAM platform). EO, IR, and acoustic sensors have relatively short detection ranges providing relative bearing and elevation, but they are slow, susceptible to weather constraints, and are not usable in IMC conditions. Synthetic Aperture Radar has a decent detection rate providing distance and relative bearing, but it has low accuracy (and high size, weight, power, and computing requirements). Both Light Detection and Ranging (LiDAR) and vision-based systems have a short range of operations that might be affected by other factors.

#### **4.3.3.4 Separation of UAMs**

To ensure UAM separation between other aircraft (UAM and other airspace users), CNS principles and technologies shall play a fundamental role in ensuring the safety in the sky. Hill et al. (2020) states that separation shall be ensured using Performance-Based Navigation (PBN) principles, sensors, and PSU network data sharing. Since the separation standards for UAM aircraft are much different from regular ATC procedures, factors like performance, operating environment, and flight planning will be crucial for ensuring safe separation.

Mueller et al. (2017) recognized that current separation standards would not apply to urban environments, comparing a standard 3-mile Instrument Flight Rules (IFR) separation radius to be as large as most of the San-Francisco area. IFR for ODM aircraft is much more challenging to implement compared to Visual Flight Rules (VFR) with a “well-clear” separation. Three separation layers are expected to apply to ODM aircraft: a multi-layer strategy with specified corridors and alternating altitudes based on the direction of flight; separation assurance using time constraints; and collision avoidance used to make the appropriate maneuver when the aircraft are on the collision

path. While Cotton (2020) produced similar expectations for ODM, their analysis went further by identifying the approximate separation criteria for UAM interactions with different operations.

- Passenger UAM interaction with a cargo or passenger UAM is proposed to maintain 250 ft vertical and longitudinal separation, while lateral separation will be defined based on the operating speed.
- Passenger UAM interaction with a VFR aircraft requires 4,000 ft lateral, 450 ft vertical, and ¼ mile longitudinal separation.
- Passenger UAM interaction with an IFR aircraft requires 3 miles lateral, 1,000 ft vertical, and 2 miles longitudinal separation.
- Passenger UAM interaction with an Autonomous Flight Rules (AFR) aircraft is proposed to maintain 500 ft vertical and ½ mile longitudinal separation and lateral separation based on the operating speed.

#### **4.3.3.5 Flight Planning/PSUs**

Flight planning addresses many factors responsible for ensuring safe operation across all types of aircraft including UAM. Lascara et al. (2019) looked at flight planning as an essential tool in determining the most favorable path for UAM flights. As such, the route planning must consider aircraft performance, attain ATC and other permissions, and use only the most preferred pathways determined by the UAM fleet operator. Hill et al. (2020) envisions flight planning to be the responsibility of PSUs, as they have the most access to shared information and direct communications with ATM systems. A fleet operator would submit a proposed operations plan to the PSU with a flight path, planned arrival/departure times, alternate vertiports/vertihubs, and other supplemental data, to which the PSU addresses strategic deconfliction and approval. PSU may also serve a critical role in smoothing any imbalances, prior to AAMs taking flights, by coordinating across operators/other PSUs thus minimizing tactical interferences.

According to Patterson et al. (2018), a typical UAM mission profile begins with aircraft taxi, where aircraft can either be manually moved or use wheels/hover for 15 seconds at 10% of cruise power. Next, the UAM aircraft would take off vertically at 100 ft/min for 50 ft. The aircraft would then transition into an ascending flight path; however, this operation varies by aircraft configuration. While helicopters can do this instantaneously, Vertical Take-Off and Landing (VTOL) aircraft can take additional time at this stage to transition the aircraft into its forward flight mode. Based on the planned altitude, the aircraft should climb from that position to the above-mentioned altitude at approximately 900 ft/min, meaning the aircraft would reach at least 500 ft one minute after take-off. Upon reaching the desired altitude, the aircraft enters cruise flight at the speed that maximizes its range with the capability of climb at 500 ft/min. The descending path will depend on the aircraft type before entering the 30-second hold over the landing area for additional clearances. A related requirement that was added to such execution is to have 20 minutes of cruise reserve.

Bosson and Lauderdale (2018) discussed that as there is no one prevalent Electric Vertical Take-Off and Landing (eVTOL) aircraft proposed for use by fleet operators, it is much harder to establish a universal flight profile. While the flight phases are the same for every UAM, transitions between separate phases are still merely assumed.

#### ***4.3.4 Impact of UAM Integration on Air Traffic Controller Workload***

With the addition of the new entrants into NAS, it is crucial to evaluate its impact on ATC performance as the most limiting factor for airspace capacity considerations. Thippavong et al. (2018) established that UAM integration should neither burden the current ATC infrastructure and automation capabilities nor add any additional workload to controllers' routine beyond the current duties. UAM flights are initially envisioned to operate under ATC like VFR traffic, especially for flights within Class B, C, or D airspace. Constraints from ATC workload limits the upscaling of operations if improperly integrated. This implies that emerging operational concepts, technologies, and procedures that do not require thorough ATC interaction should enable high-density operations within the UAM paradigm. According to Rollo et al. (2017), increased ATC workload would only occur for airspace classes A-C, mostly due to the unreliable communication links incurring the transmission delay and poor connection quality.

As the new operations emerge, controllers must assume a new set of responsibilities to accommodate the new entrants. Mueller et al. (2017) predicts ATC to have insight into ODM operations during nominal operations with the ability to intervene whenever safety may be compromised, which can eventually increase the controller's workload. As the system capacity and ATC workload are interdependent, certain approaches would need to be established to ensure the growth of operations without imposing extra work on the controllers. While the FAA's (2020a) authors do not envision much of the additional workload to be put on air traffic controllers, they outlined some of the new responsibilities that may challenge current ATM systems. As UAM aircraft are established within corridors, ATC does not control or communicate with those flights; though, they do have access to the operational data to ensure the safety of other NAS operations. Controllers do establish the corridor route availability as well as provide guidance to UAM aircraft that leave the corridor during a contingency scenario.

Certain strategies have been reviewed to minimize the impact of UAM operations and mitigate the extra workload on ATC system. Vascik and Hansman (2017) dug deeper and estimated that over 92% of ODM flights would need to enter Class B, C, or D airspace, which requires contact with ATC. Since the structure of low-level airspaces around airports (i.e., upside-down cake) takes up a large chunk of airspace managed by ATC, it adds a lot to their workload, especially when coupled with separation assurance. Visual meteorological conditions operations could relieve a lot of workloads from controllers as pilots can self-separate via see-and-avoid and well-clear rules, which could support increasing the density of operations. Revisions of separation standards remain necessary to utilize the accuracy of modern CNS equipment and reduce operations densities in the environment. With respect to airspace allocation, improvements, such as airspace redesign to include only used volumes, definition of permanent Special Flight Rules Areas, and organization of dynamic airspaces with "open/closed" status (such as DDCs), would help to relieve some of the ATC workload and allow scalability of ODM operations.

#### ***4.3.5 Infrastructure Requirements Necessary to Support UAM Integration into the NAS (including Terminal Environments)***

This section discusses the infrastructure requirements for UAM as described in the literature. This includes general infrastructure and corridors. It also addresses public acceptance concerns of UAM operations and the associated infrastructure supporting the operations. Lastly, infrastructure considerations for multi-modal transportation are discussed.

#### **4.3.5.1 UTM + NAS General Infrastructure**

Infrastructure requirements will emerge to support UAM operations compatibility with UTM airspace and the NAS. Stouffer et al. (2020) listed a few essential infrastructure features that included vehicle-to-vehicle communication, enhanced situational awareness tools, air-to-air and air-to-ground data exchange, and communication links. Some of the mentioned specifically required ground infrastructure included Mode-C multilateration, Airborne Collision Avoidance System (ACAS)-X, 5G capabilities, advanced Doppler Ranger Gating Range, infrared sensing, bistatic radar, and acoustic detection. Some of the required infrastructure for ATM include ADS-B and integration of UAM aircraft operations into the FAA's Data Comm program. These requirements are needed for expanded real-time communication, enhanced navigational accuracy, and assurance of proper separation and management of UAM aircraft within the PSU networks.

Hill et al. (2020), Air Traffic Control Association (2021), and Lineberger et al. (2021), all agree that supporting infrastructure development faces challenges due to limitations from energy generation, distribution, and storage used for UAM operations, such as vertiports, maintenance facilities, and other required infrastructure. Hill et al. (2020) and Lineberger et al. (2021) believe that further supporting infrastructure should include data collection and dissemination networks for UAM data exchanges, PSUs, UAM vertihubs and vertiports (incl. corridors and UOEs), and fuel/power suppliers.

With the significant additional infrastructure needed to fully integrate UAM within the NAS, Thipphavong et al. (2018) expressed concerns over the amount of this infrastructure. Identified potential hazards relating to infrastructure included the lack of vertiport availability and inadequate ground crew training for maintaining safety margins.

#### **4.3.5.2 Corridors (Actual Corridors, Operating Areas, and Helicopter Routes)**

Like the NAS's established network of routes and airways, numerous UAM routing concepts have been proposed leveraging a similar structure. In the FAA's UAM CONOPs, the idea of UAM corridors was introduced as a method of conducting safe flights without ATC separation of the aircraft (FAA, 2020a). UAM Corridors are not meant to be a replacement for ATM or UTM, but a supporting method where PSUs manage flight separation along fixed paths. The corridors will initially be limited to point-to-point paths between aerodromes but are likely to evolve into more complex networks of connected aerodromes. They will have an internal structure as well as incoming and outgoing air traffic, operating at different altitudes. Flight separation in the UAM corridors will be handled primarily by flight scheduling to de-conflict and raise awareness of new procedural rules. The UAM operators flying in the corridors are responsible for maintaining safety of flight and awareness of other flights, but regulations governing operations in the flight corridor will have to be continually updated to account for increasing automation and beyond visual line of sight flights. ATC control of corridors will be kept to a minimum by setting corridor availability and handling the off-nominal events.

The FAA UAM CONOPs also introduced nominal and off-nominal UAM use cases (FAA, 2020a). The FAA considers nominal use of UAM to be flights conducted in the UAM corridors, which consist of planning, departure, enroute, arrival, and post-op phases. Two off-nominal use cases are given by the FAA. The first is a flight within the corridor non-compliant to the original flight plan. If the vehicle strays from the flight path for any reason, then the UAM operator should update their PSU



and notify other PSUs of the event. Decisions will then have to be made as to whether the aircraft can continue operations or if the operation should continue in the new airspace it occupies. Once a decision is made, the arrival and post-op phases will continue as a nominal case given there are no arrival interferences; an off-nominal report will need to be written. The second off-nominal case presented is the event of a failure resulting in a forced landing. In this case, the aircraft is expected to exit the UAM corridor with ADS-B transponder turned on and ATC notified, depending on airspace classification. The PIC of the aircraft should focus on flying, and the UAM operator should contact ATC with the contingency plan to mitigate risk to other aircraft.

#### **4.3.5.3 Public Acceptance, Noise Impact, and Safety**

The placement and robustness of infrastructure impacts the public acceptance of UAM, which plays a significant role in its adoption, demand, and usage. Dietrich (2020a) states that UAM aircraft companies need to gain social acceptance to continue vehicle production. Achieving this goal might be particularly challenging since people are already resistant to helicopters, existing UAM vehicles, and other new technologies (also explored by Vascik and Hansman (2017)). The articles highlight noise pollution generated by rotors as an inhibiting factor in acceptance. Other factors include mistrust of the system's novelty, underestimated advantages to the community, and the assimilation of UAM within society.

According to Wisk (2021), AAM operations would need to satisfy the public's auditory and visual needs. Like Thipphavong et al. (2018), the study proposed limiting hours of operations or route planning around minimally populated or already noisy areas (i.e., highways). Flight altitudes need to be evaluated to minimize the visual impact and increase visual acceptance. With AAM corridors, the flight paths should become more routine and less unsettling to the public. The study further explained that the AAM aircraft's auditory and visual factors would fade away when AAM aircraft benefit most of the community.

Studies showed that the characteristics of the UAM vehicles and the types of operations they are intended to perform influence the public perception of UAM safety and community health/lifestyle. Hill et al. (2020) found that demand for UAM systems would increase if UAM companies present successful safety tests. They also considered benefits to the community when UAM is introduced into the community lifestyle.

Public acceptance has a tremendous impact on the locality of UAM operations. The correct choice of cities where the implementation of UAM can be successful requires making an accurate demand analysis and prediction. Garrow et al. (2018) is one of the first works conducted on focus groups to estimate the demand for UAM. The study predicted that high-income users will be the first adopters of the air services due to busy schedules and ability to afford the services.

The public's main issue with integrating AAM vehicles into the airspace, according to community research, is frequently whether the vehicles will be too loud. For NASA's aircraft design tools to accurately estimate noise levels for eVTOLs like Joby's, the agency is collecting and analyzing data from these types of aircraft. Manufacturers can create their vehicles for silent operation in urban and rural locations by using tools that accurately estimate noise. AAM routes and low-noise flight paths can be defined and optimized using the data, which will also help the Federal Aviation Administration (FAA) develop policies. The FAA will use all it has discovered from these tests to guide its continued work on operations and airspace integration.

After some of the testing as part of NASA's Advanced Air Mobility National Campaign, data analysis revealed that Joby's aircraft had achieved the ground-breaking low noise goals the company had set for itself. The aircraft measured a sound level of 45.2 A-weighted decibels (dBA) at 1640 feet (500 meters) of altitude and 100 knots of airspeed, which Joby says will hardly be audible in urban environments.

#### **4.3.5.4 Multi-Modal Transportation Considerations**

Considering competitiveness of transportation modes, such as automobiles, public transportation, and autonomous taxi service, Fu et al. (2019) attempted to understand the public's potential adoption of UAM service. Based on the market segmentation, several multinomial logit models were evaluated; safety, travel time, and travel cost were the most critical factors that would influence the public's choice. In comparison to the users of ground transportation modes, the UAM users are expected to stress the time variable the most (Fu et al., 2019). The results obtained in the study were integrated within the travel demand model, and applied to the Munich Metropolitan Region, resulting in UAM market share estimations ranging from 0.16% to 0.38% (Moeckel et al., 2020). Plötner et al. (2020), indicates that UAM travel for short distances (<5.4 NM) has a potential model share of 0.5%, by trying to employ UAM to complement public transport. Both studies concluded that the effect on existing traffic patterns from UAM is negligible.

Zhou (2012) and Nurden et al. (2007) found that age and economy are key factors for transport services demand. More specifically, Tyrinopoulos and Antoniou (2013) noticed that customers between the ages of 35 and 44 had a higher preference of using a private car. According to the survey noted from Panel (2018), UAM users are even inclined to pay 2-2.5 times the original price of a taxi in the United States and Germany to reduce their travel time up to 50%.

Wisk (2021) argued that many UAM services use eVTOL aircraft because of their minimal environmental and auditory impact. AAM transportation is projected to strengthen airport-community connections by ensuring more direct access to the airports. Passengers could also use eVTOLs to connect nearby vertiports and airports, such as tourist attractions and major hubs. Doing so shall relieve the congestion on the highways and within urban environments, as well as assist and potentially eliminate the need for outdated ground transportation services.

#### **4.3.6 Coordination of non-segregated operations between the UAM and non-UAM air traffic**

The coordination of segregated and non-segregated airspace elements between UAM and non-UAM air traffic must be addressed to ensure safe UAM integration into the NAS. The National Academies of Sciences, Engineering, and Medicine (2020) explains that integrating UAM aircraft into the same airspace with traditional aircraft is more efficient than separating them. Even though the initial operations are divided between UTM and ATM, the long-term solution is expected to incorporate all operations in one system.

As many studies described using a corridor structure for UAM operations, the survey explores how the coordination of these structures and operations could happen. Nguyen (2020) recognized that despite UAM corridors being in place, pilots of this aircraft type must contact local ATC for operation permission if they are operating in the vicinity of non-UAM aircraft. The study found a combination of DDC and 4D RNP systems could not only reduce traffic conflicts with non-UAM aircraft but also make ATC clearance unnecessary. FAA (2020a) explains that UAM aircraft might

enter other airspaces whenever maintaining separation in the corridors becomes impossible, for example, due to weather. However, the operators must obey the airspace's rules while in the airspace outside of the corridor system. After observing the helicopter's operations, Verma et al. (2020) found that digital communication would not be possible for UAM aircraft with the current aviation system. The study proposed a UTM-like system that separates UAM aircraft from traditional aircraft using designated airspace, routing, and constant deconfliction. Exploring possible UAM routing near busy commercial airports, Syed et al. (2017) found that UAM vehicles could fly around or below the traditional aircraft's approach area. This routing design allows UAM aircraft to be properly separated and avoid wake turbulence from the traditional aircraft while flying more direct paths.

The development and implementation of new flight rules must be considered in designing a non-segregated operational concept. Cotton (2020) evaluated a proposed concept of AFR for non-segregated operations in the same flight environment. The experiments were successful for mixed operations, even accounting for harsh IFR separation standards of 1,000 ft vertical and 3 miles in trail. Using automated prediction principles and tactical coordination, AFR flights can resolve conflicts within the non-segregated airspace without having to follow corridors or designated paths. Using the Digital Flight Rules (DFR) concept, Wing and Levitt (2020) stated that UAM and traditional aircraft could utilize the same airspace for flights. As VFR and IFR co-exist in the same airspace, they found that DFR operations may be safely integrated into the same airspaces. Regardless, DFR aircraft must still give way to aircraft operating under different flight rules.

#### ***4.3.7 Recent Industry Advances toward UAM Integration***

UAM/AAM has emerged as a branch of air transportation that requires investigation of past, present, and future progress relevant to a successful establishment of the market. The team has analyzed the latest news from the UAM/AAM community to be inclusive of industry trends through news and other sources outside of traditional academically published routes. Bhadra (2021) shows that the latest FAA concerns and points of interest are extensions of battery density, improving autonomy, developing 5G/Low Earth Orbit communications and other physical infrastructure, regulations, security, etc. The near-term operations are expected to be piloted using certified eVTOLs in allocated airspace with possible waivers or exemptions.

As helicopter operations remain one of the most viable business transportation outlets, Cook (2021) argues that two of the upcoming bills imposing critical limitations to these flights in the New York City area could be detrimental to innovations and technological developments for similar operations. One of the bills is proposed to tighten noise regulations even more than current levels, while the other bill requires the collection of a wide variety of documentation relevant to each operation. While already being heavily regulated, imposing further limitations may affect up to 80% of current helicopter flight numbers.

Poole (2021) sees numerous investments in eVTOL technologies set too high of the expectations for the timeline of vehicles' roll-up. Lineberger et al. (2021)'s projections of first revenues by 2025 were deemed too optimistic due to unknown certification standards, demand, pricing, and airspace management tools.

Polek (2021) says that multiple aviation stakeholders, such as American Airlines, Virgin Atlantic, and Avolon, have ordered 1,000 Vertical Aerospace aircraft for their regional connectivity. As

aviation goes electric, most of these companies are trying to develop sustainable and emission-free networks of regional routes connecting their markets and hubs even further.

#### **4.3.8 Vertiport Design and Planning**

##### **4.3.8.1 Vertiport Design and Infrastructure Considerations**

VTOL aircraft will use aerodromes known as vertiports. Published September 2022, the “FAA Engineering Brief No. 105, Vertiport Design” (FAA, 2022) provides interim guidance on the design requirements of facilities to support VTOL operations. Elements of vertiport design it addresses includes:

- Vertiport design and geometry,
- Marking, lighting, and visual aids,
- Charging and electric infrastructure, and
- Site safety requirements.

Many sources, such as the FAA, NASA, and other stakeholders, cover the design of these vertiports, showing many similarities, especially in design philosophy. The key differences are presented via vertiport contributions to the AAM community. According to NASA (2020c) and Lillium (n.d.), the current design of vertiports accommodates various types of VTOL aircraft that can carry cargo and passengers. NASA has created three main concept designs of vertiports: vertihubs, vertiports, and vertistops. These main design differences give vertiport developers the ability to apply different structural aspects at more varying and strenuous locations compared to traditional airports (NASA, 2020). According to Lilium (2020), the three key pieces to a vertiport are take-off areas, parking stands, and terminals.

Lilium (2020) has provided many design concepts for vertiports with four sizes and three organizational designs. The four sizes are micro, small, medium, and standard. Micro consists of one Take-off and Landing Area (TOLA) with two parking spots, small consists of one TOLA and four parking spots, medium consists of one TOLA with six parking spots, and standard consists of two TOLAs and eight parking spots. The three organizational designs are linear, where parking spots are in a straight line and all aircraft take a similar path to the takeoff area; back-to-back, where parking spots are back-to-back with a similar path; and courtyard, where parking stands are facing each other in a square design with the TOLAs located at the end. Another design by Pries (2021) is a satellite style design, where the gates are in a semicircle, connected to a pad.

Hill et al. (2020) defined the vertiport design’s objectives to be able to handle extensive volumes of passengers and various aircraft types, obey “the safety and efficiency of the NAS,” and be mindful of public complaints. Along with Sengupta et al. (n.d.), they explain the vitality of a vertiport’s location and include the limiting factors: flight areas, utility accessibility, current urban structures, UAM noise production, and environmental objects, such as trees, waterways, or prevailing wind patterns. Many vertiports must also be able to handle UAM emergencies or alternative landings.

Quite a few researchers describe different operational scenarios and features that would be essential to consider when designing UAM operations. Hasan (2019) projected metropolitan vertiports to serve on average 20-minute trips. Vertiport operations would follow a hub-and-spoke method where hubs in urban areas connect the spokes in suburban areas. Hall (2020) stated that turnaround times

would determine the number of vertiports an area requires to satisfy UAM demand. Fewer vertiports will be necessary if turnaround times are quick. Addressing vertiport readiness, Bosson and Lauderdale (2018) considered the five-minute window before departure to be the standard time interval for industry-wide use. Vertiport design must reflect proposed vertiport scheduling standards and vertiport throughput characteristics to match flight demand and vehicle maintenance intervals. To model the day-to-day operations, Guerreiro (2020) estimated that vertiports would follow the first-come-first-served algorithm. The study results showed that while using the first-come-first-served concept might not allow vertiports to always operate efficiently, this concept of operations allows a throughput of over 80% of flights, which might be the most efficient for UAM operations.

To summarize the design, operational factors, and infrastructure, NASA (2020b) expects passenger vertiports to serve 80-120 aircraft operations per hour, allocating multiple large landing spots with a throughput of about 12 parked vehicles. High service vertiports will be around the urban centers' outer edges due to their size. Urban areas will also have vertistops handling one aircraft at a time, possibly for emergency landings.

Mihir (2021) presented a framework that estimates noise levels from a full day of UAM operations in Northern California and Dallas-Fort Worth regions and determined how UAM flight trajectories are derived from an output of mature-state demand analysis. The study uses Robinson R44 as a surrogate UAM vehicle and modifying its NPD curves, Block Group level DNL values are estimated for two reduction scenarios (10-dBA and 15 15-dBA). According to the current state of knowledge, 10-dBA reduction from the traditional helicopter is achievable, but 15-dBA reduction could be challenging. Noise results from both scenarios are compared to understand the impact of extra 5-dBA reduction.

In Northern California, the area impacted (>45 DNL) decreases by 80% and population under influence decreases by 79%, on increasing reduction level from 10 dBA to 15 dBA. In Dallas-Fort Worth, the area and under influence (>45 DNL) decreases by 78% and population impacted decreases by 72%, on increasing reduction level from 10 dBA to 15 dBA. A vertiport level analysis was performed in the AEDT tool to develop DNL contours from UAM operations at Financial District vertiport in San Francisco. The area, population, and daytime population under DNL contours significantly change based on the reduction levels. The shape of the DNL contour is influenced by geographic travel patterns and airspace restrictions. Mihir's findings indicate also that a massive reduction in the noise footprint of UAM operations is observed on an increasing reduction level. Therefore, achieving reduction levels close to 15-dBA is recommended for mature state operations.

#### **4.3.8.2 Planning Vertiports**

Vertiports, when integrated and designed correctly, can be highly effective modes of transportation. While the design of these vertiports is what makes them effective in operation with passengers and cargo, the size, scale, and tools at the disposal of a specific vertiport are crucial for efficiency. This is where planning comes into place, so that certain locations have the right equipment and space to repair and park VTOL aircraft and drones, along with maintaining passenger throughput and proper services for operations. Different buildings and services should be compared among all locations. Locations of vertiports differ by offered services and TOLA design (vertihubs, vertiports, and vertistops), according to NASA (2020). Vertihubs will be placed outside of suburban areas, vertiports

will be placed in the middle of urban areas such as cities, and vertistops will be placed in suburban areas. With varying locations and unique services around the vertiports, it is easier to pick the locations based on the provided criteria. When all vertiports properly serve the major cities, they should be able to effectively operate in unison.

NASA (2020) outlined that general demand requirements would need to be considered for vertiport placement. The number of gates will have to be chosen based on the arrivals per hour and occupation time before the next aircraft arrival (Lim and Hwang, 2019). Planners will have to consider the services offered at each location, as well as the areas of the highest demand. According to NASA (2020), vertiports will have to follow strict regulations due to noise, ATC, other transportation, and quality assurance of the aircraft, as well as physical infrastructure.

#### **4.4 Methodology**

The KDAB airspace concept was used to model the airspace environment including UAM corridors, vertiport locations, vertiport ingress/egress, operational limits (altitudes, velocities, etc.), and CNS requirements. The rationale behind this concept was to combine already existing airspace elements with the novel concepts of UAM operations and environment. Simulation scenarios used for the purpose of this study attempted to closely replicate the team's vision for an airspace environment based on the literature review, FAA guidance, and subject matter expertise.

This section discusses the airspace design for a notional UAM operations environment in the vicinity of KDAB.

##### ***4.4.1 Standard KDAB Environment***

The air traffic control facility at Daytona Beach is a Class C airspace up-down air traffic control facility, which includes the ATCT and Terminal Radar Approach Control (TRACON). KDAB TRACON also provides ATC service to Ormond Beach Municipal Airport (KOMN) Class D Contract ATCT, New Smyrna Beach Municipal Airport (KEVB) Class D Contract ATCT, DeLand Municipal Airport-Sidney H Taylor Field (KDED), Flagler Executive Airport Class D Contract ATCT, and Spruce Creek Airport (7FL6). Analyzing the immediate proximity to KDAB, there are multiple airports and Class D airspaces, as shown in Figure 4.1. KOMN with Class D airspace is located northwest of KDAB; it shares the boundary of the KDAB's inner Class C ring. Directly to the south of the airport, there is 7FL6 private airport right outside the inner ring but within the outer ring of KDAB Class C airspace. To the southeast, there is KEVB airport with a larger part of its Class D airspace underlying the outer ring of KDAB's Class C airspace. Another airport that is important to consider is KDED, located southwest of KDAB, outside of the outer ring of Class C airspace. It is uncontrolled but often used for skydiving activities.



Figure 4.1. Daytona Beach Airspace on a VFR Sectional Chart.

KDAB has three operational runways: 7L/25R, 7R/25L, and 16/34. Runways 7L/25R and 7R/25L are parallel, while runway 16/34 intersects both. The most common runway in use is 7L/25R; however, runway 7R/25L is commonly used for VFR closed traffic pattern, and runway 16/34 is commonly used during unfavorable wind conditions, practice Area Navigation (RNAV) GPS approaches, and practice circling approaches. Land and Hold Short (LAHSO) of runway 25R and 7L is available on runways 16 and 34.

Most of the traffic in the KDAB airspace is general aviation with some commercial flights arriving and departing throughout the day. There is significant flight training at KDAB, including a large Embry-Riddle Aeronautical University fleet of aircraft. There are eight published Instrument Approach Procedures (IAPs): two Instrument Landing System (ILS) or Localizer approaches (both to runway 7L/25R), and six RNAV approaches (two for each runway).

#### 4.4.2 UAM KDAB Environment

Because UAM operations have distinct infrastructure requirements that differ from the existing infrastructure commonly used by the aviation community, UAM infrastructure requirements were considered during designation of the operational environment for UAM flights. UAM routes, destinations, altitudes within the KDAB were considered based on local points of interest and mostly come from the literature review, as well as SMEs opinions from within the team and other ERAU resources. It is important to note that any new aircraft entrant to the NAS may create antagonism with the aviation community. However, new entrants will have the privilege of using the NAS if they are safe. Common sense must be used when considering their impact on the current flying community. Safety is paramount on the new entrant's acceptance into the NAS, and the impact on current users should be minimal. UAM corridors and On-Airport vertiports need to be designed by a team that would include ATCT SME personnel input to mitigate a wide range of ATC issues surrounding an aerodrome (e.g., IAP procedures, VFR traffic patterns, ATC SOP, and other local

area considerations), UAM operators, pilot groups, airport personnel, and other interested parties. Once designed, tactical considerations for current weather (IFR, icing conditions, convective weather, etc.) must be considered and procedures developed to ensure safety.

#### 4.4.2.1 Take-Off and Landing Areas

The team first considered UAM infrastructure projections for take-off and landing. Upon investigation and analysis of suitable locations within the vicinity of KDAB, two vertihubs and one vertiport were set in place. KDAB vertihub were placed in a north-western part of the airport, as shown in Figure 4.2. That location was selected based on a discussion about possible implications for the most common operating runway, 7L/25R, and functionality when runway 16/34 is active. The team’s design includes enough apron space to place a vertihub with at least two vertipads and six parking spots using a layout outlined in Syed et al. (2017). Further studies may indicate the ideal location for the On-Airport vertiport could be a new structure above a parking lot, immediately adjacent to the Terminal. This would allow UAM passengers to easily access the terminal and TSA. Further research is needed in this area, which falls outside the scope of this project.

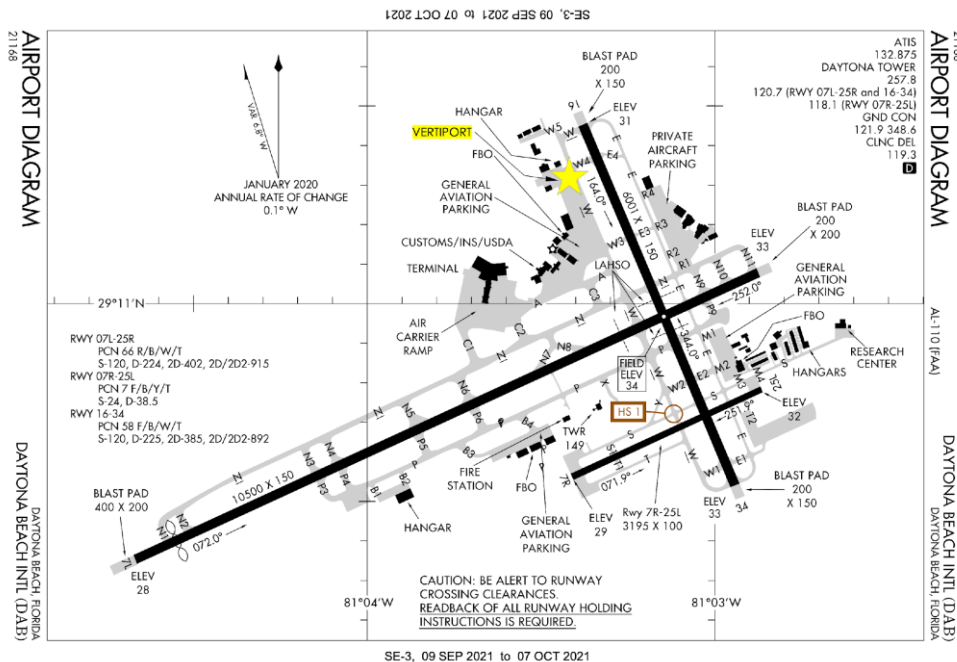

Figure 4.2. KDAB diagram with a proposed vertiport location.

The Orlando International Airport (KMCO) vertihub was placed in the vicinity of KMCO; however, since the airport is out of the operational scope for this study, the exact location was not specified. The team does envision it to be in the vicinity of Terminals A and B based on the preliminary evaluations of the airport structure and existing literature guidance. Further research is needed in this area, which falls outside the scope of this project.



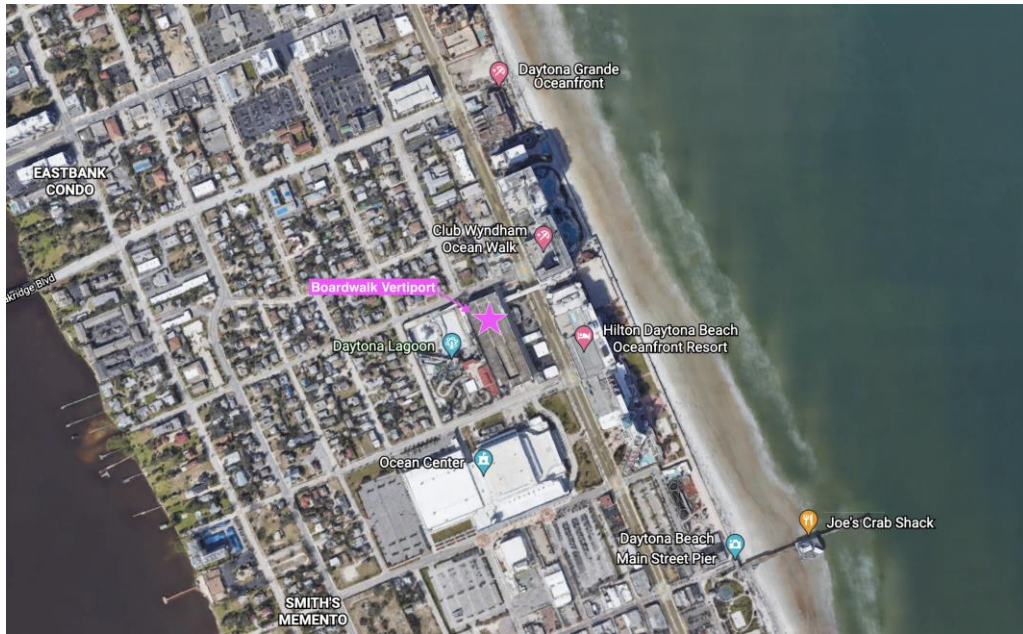

Figure 4.3. Preliminary Daytona Beach Boardwalk Vertiport Site.

The Daytona Beach Boardwalk Vertiport was placed on top of the parking garage building located on the beachside in one of the most popular tourist areas, as shown in Figure 4.3. The parking garage is one of the tallest suitable structures in that vicinity and has enough space to set up a vertipad and vertiport equipment. It also has easy access to major tourist attractions that would be of interest to UAM users.

The Daytona Beach Boardwalk Vertiport destination was selected based on the tourist survey data provided in market research from Mid-Florida Marketing & Research, Inc. (2021) where they highlighted main areas of interest and activities that make these destinations attractive. Nevertheless, all these destinations should satisfy the FAA and industry's vision for airport-to-vertiport type of UAM operations. Airport to Airport may be a future consideration for Mature State Operations as defined in FAA ConOps 1.0 (3.3 Mature State Operations) to form a network to optimize paths between an increasing number of aerodromes but was not researched in this study.

#### 4.4.2.2 Airspace Features

Once all three locations were placed, the team could better assess the airspace features and nuances before moving forward with corridor network modelling. One of the main airspace considerations for a proper protection of traffic flows in and out of KDAB and airports in its immediate vicinity came from Vascik and Hansman (2020), using 1.5 NM radius of protective airspace for UAM VFR operations alongside the open runways within 5 NM of the airport. The research team realizes that the specifics of UAM corridor design, pattern, and operation would vary on an airport-by-airport basis. Considering KDAB, most traffic utilizes runway 7L/25R with occasional 16/34. That indicates that the corridor pattern and status shall be dynamic throughout the day and change based on the runway status.

#### 4.4.2.3 Ground Obstructions

Even though Daytona Beach and its surroundings do not have many obstructions or tall buildings in the vicinity, the team has found a few ground features that may be of concern to the UAM operations and corridors set up, as shown in Figure 4.4. The closest ground obstruction to KDAB is Daytona International Speedway. It is located 0.87 NM northwest of the airport with the highest point of approximately 165 ft. Another close obstruction that might be of concern to the UAM traffic is Halifax Health Medical Center. It is located 1.3 NM north of the airport and stands approximately 220 ft tall. An obstruction that was found to have an impact on obstruction clearance during corridor placement considerations was Advent Health Daytona Beach Hospital. It is located 4.6 NM northwest of the airport with the highest point of 250 ft. The last consideration is the buildings in the vicinity of Boardwalk vertiport, which are less of a concern to UAM flights due to the UAM ingress/egress path.

The vertiport is located on top of a parking garage 3.95 NM to the northeast of KDAB standing 65 ft tall. While there are no obstructions in the UAM approach/departure path, the buildings surrounding the parking garage from the northeast stand from 158 to 263 ft tall, as shown in Figure 4.5. The distance to the closest obstruction of 180 ft with an approximate height of 350 ft.



Figure 4.4. Impactful Obstructions in the vicinity of Daytona Beach.

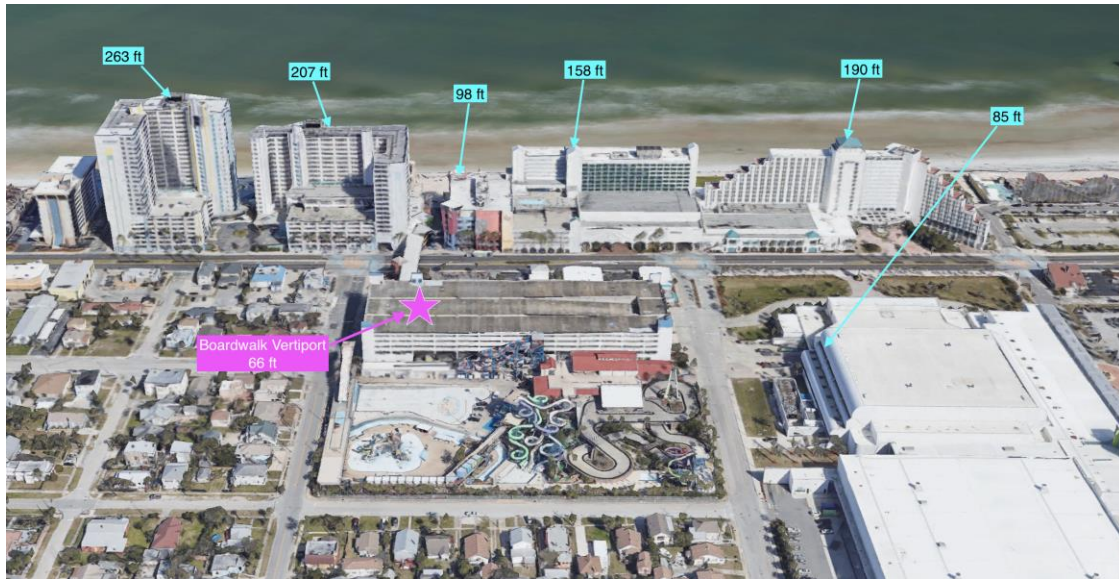

Figure 4.5. 3D View on Ground Obstructions around the Boardwalk Vertiport.

#### 4.4.2.4 KDAB Corridor Configurations

After many theoretical designs for corridor placements, configurations, and operational rules, the finalized conceptual corridor configuration and network combined the information learned from other studies, within-the-team expertise, local SMEs, and the FAA’s guidance. The proposed concept includes a network of dynamic corridors located directly to the north of KDAB with four transitions. Note: The two corridors, four transitions, and the fix names were used for the simulation in this research, and they are not currently used for any current air traffic navigation, except for the FOLIG intersection on the ILS RWY 7IL approach.

There are two proposed corridor configurations: BEACH UAM VFR Standard Instrument Arrival (STAR) or Standard Instrument Departure (SID) and NASCAR UAM VFR STAR or SID. The BEACH configuration routes traffic from KDAB vertihub to the east, and NASCAR configuration routes traffic from KDAB vertihub to the west, north or north and then east if KDAB RWY 16 is operational. Within these two configurations, there are four transitions shown in Figure 4.6: TOMOKA (purple), FOLIG (pink), RIDDLE (yellow), and ORMOND (red). All transitions act as UAM VFR STARS, VFR SIDs, or Departure Procedures. UAM aircraft are expected to use the same routing with arrival and departure flows using vertical separation, lateral separation, or one-way routings, The TOMOKA transition routes the traffic to and from the northwest direction. It is also a part of the FOLIG transition. The FOLIG transition routes the traffic to and from the southwest direction, including the traffic from KMCO vertihub using KMCO path. Both RIDDLE and ORMOND transitions route to and from the Boardwalk Vertiport, but the specific transition used for the flight depends on the runway in-use. In addition, both transitions can be used to lead traffic to and from the northeast and southeast directions.



Figure 4.6. A proposed concept of corridor network with all transitions included.

The TOMOKA transition leads UAM aircraft to and from the KDAB vertiport to DMALL, BUCEE, and TIGER, as shown in Figure 4.6. It is used as a part of FOLIG transition between the KDAB vertiport and TIGER. The path between the vertiport and DMALL passes by the Daytona International Speedway structure, but it is separated following the proper obstruction clearance for UAM traffic. After proper PSU coordination of intent, UAM traffic may enter or exit the NASCAR UAM VFR STAR or SID from TIGER or FOLIG,

The FOLIG (Figure 4.7) transition leads UAM aircraft to and from the KDAB vertiport to FOLIG final approach fix to runway 7L using TOMOKA transition, as shown in Figure 8. This transition is critical to organize the flow to and from the notional route to the KMCO vertiport using 167° initial heading, described in Section 4.4.2.4.

The RIDDLE (Figure 4.9) transition leads aircraft to and from the Boardwalk Vertiport via COCRN, ROTCC, RIDGE, and JACKS, as shown in Figure 4.8 This transition is only available for use when Runway 16/34 is not active or if the use of this transition was coordinated between the PSU and ATCT Cab Coordinator (CC). If runway 16 is not active, UAM aircraft shall vertically climb up to at least 500 feet above the KDAB vertiport on the departure and cross RIDGE at 1,100 feet before proceeding via the rest of the route. If runway 16 is active ATC coordination is required and UAM aircraft shall vertically climb up to 1,100 feet above the KDAB vertiport on the departure and proceed via the rest of the route. The aircraft may begin the descent at the approach fix JACKS down to the Boardwalk Vertiport.

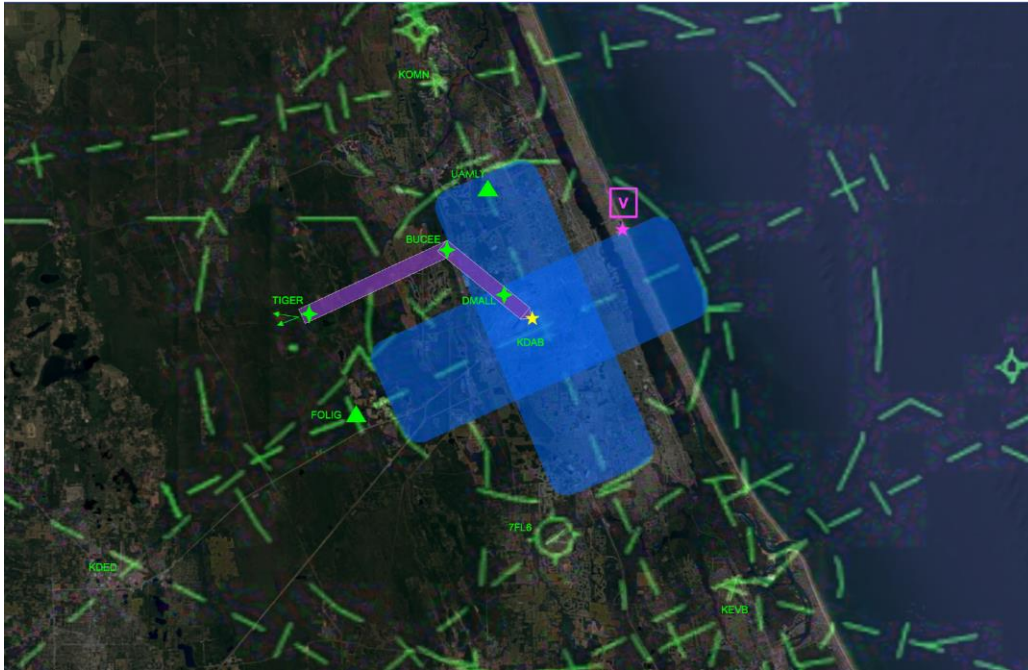

Figure 4.7. A proposed concept of the TOMOKA Transition.

The ORMOND Transition leads aircraft to and from Boardwalk Vertiport via DMALL, ADVNT, UAMLY, RIVER and JACKS, as shown in Figure 4.10. This transition is available without ATC approval, when runway 16 is active at KDAB. Most of the transition lies in the KDAB Class C airspace, and it provides procedural separation from KOMN Class D airspace. UAMLY is a fix added to the RNAV RWY 16, by the research team, to procedurally separate UAMs from NAS aircraft on the RNAV RWY 16 approach. It was designed to ensure NAS aircraft do not descend below 1280 ft (see Figure 4.10). The RNAV RWY 16 approach is not available to heavy jets without PSU/ATC coordination, to ensure UAMs have proper wake turbulence separation.

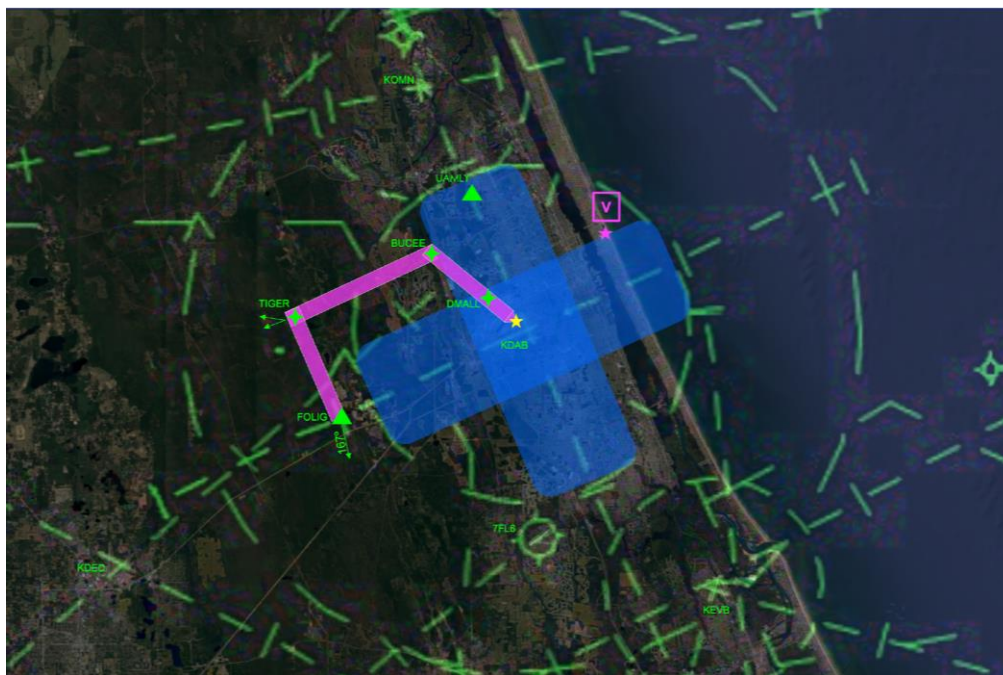

Figure 4.8. A proposed concept of the FOLIG Transition.



Figure 4.9. A proposed concept of the RIDDLE Transition.



Figure 4.10. A proposed concept of the ORMOND Transition.

Advent Hospital, Halifax hospital, and the Speedway structures are obstructions for the UAMs. The OMN transition from KDAB vertiport to DMALL to ADVNT uses lateral separation to procedurally separate UAMs from these obstructions. The OMN transition continues from ADVNT to UAMLY and to the RIVER. UAM aircraft may also use RIVER to enter or exit the corridors for the north- and southeast-bound flights and follow the coastline.

To provide more definition for each transition and corridor network, each fix and location were estimated to have the following approximate coordinates:

- KDAB Vertihub – 29° 11' 19" N, 81° 03' 26" W
- Boardwalk Vertiport – 29° 13' 49" N, 81° 00' 39" W
- FOLIG Fix – 29° 08' 24" N, 81° 09' 28" W
- TIGER Fix – 29° 10' 58" N, 81° 11' 09" W
- BUCEE Fix – 29° 13' 04" N, 81° 06' 29" W
- DMALL Fix – 29° 11' 53" N, 81° 04' 57" W
- ADVNT Fix – 29° 14' 54" N, 81° 05' 52" W
- UAMLY Fix – 29° 14' 57" N, 81° 05' 03" W
- RIVER Fix – 29° 16' 15" N, 81° 02' 35" W
- JACKS Fix – 29° 13' 38" N, 81° 01' 10" W
- COCRN Fix – 29° 13' 07" N, 81° 02' 27" W
- ROTCC Fix – 29° 11' 33" N, 81° 03' 01" W
- RIDGE Fix – 29° 11' 29" N, 81° 03' 12" W

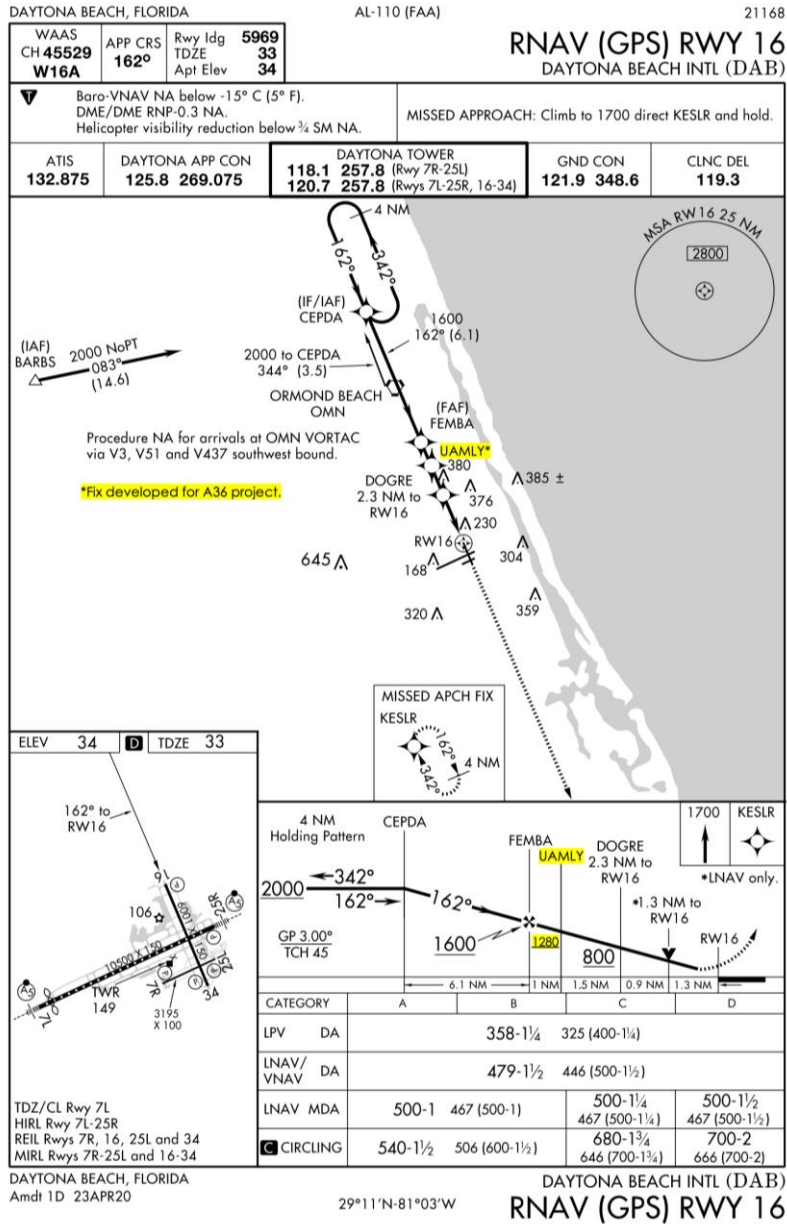

Figure 4.11. Amended RNAV (GPS) RY16 Approach Plate into KDAB.

#### 4.4.2.5 Notional Route to KMCO

ERAU's ATC Tower Lab's simulated airspace environment does not possess the airspace models necessary to simulate a route between KDAB and KMCO. To incorporate a route to and from KMCO, the FOLIG waypoint shall be used for in-bound and out-bound aircraft that would be flying that route on an initial 167° heading. For conceptual purposes, the team designed a notional route between FOLIG and a KMCO vertihub located within the general vicinity of KMCO that may be recommended for UAM utilization (see Figure 4.12). A detailed design of this route remains outside of the scope of this study because A36 WP3 focuses specifically on the ATC element in the vicinity of KDAB.



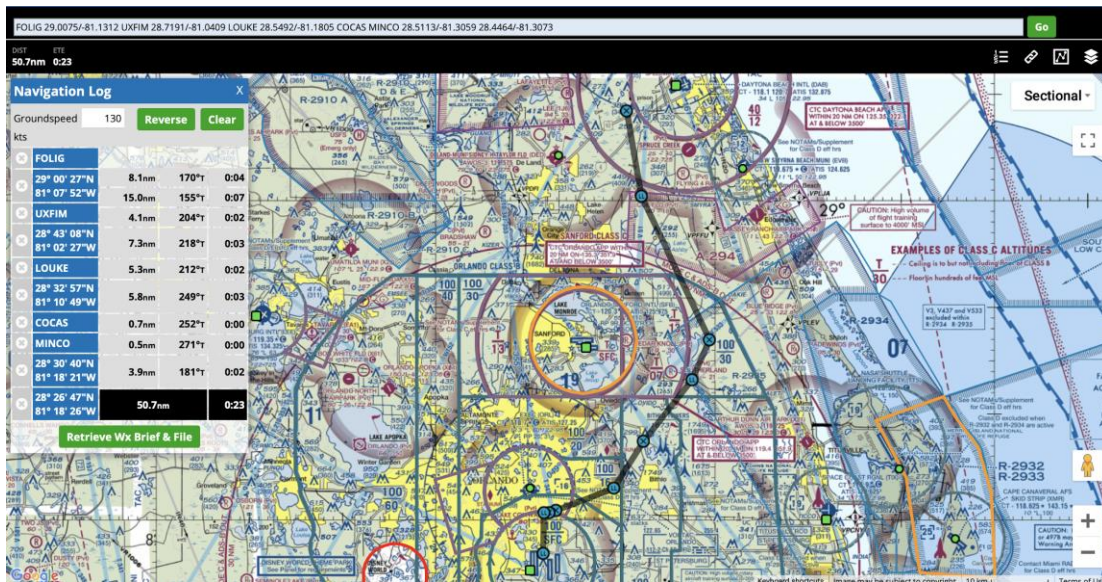

Figure 4.12. A proposed concept of the notional route from KDAB Vertihub to KMCO Vertihub.

*Note.* Route created using iFlightPlanner (2021) online software via sectional layout.

#### 4.4.2.6 KDAB Operational Restrictions

Unless coordinated with the ATCT CC and PSU, there are certain restrictions that shall be imposed on KDAB operations with the addition of the corridor network within the airspace. These are:

- Circling approaches for RY7L/25R shall not be allowed when the corridors are in use as these procedures will shut down the TOMOKA or RIDDLE transition.
- RY7L left traffic and runway 25R right traffic shall not be allowed as they will create a safety hazard to the UAM operations in the corridors.
- RY7L arrivals are restricted, staying at or above 1,600 feet until FOLIG.
- To avoid intersecting the Riddle transition, VFR/IFR RY7L departures MUST:
  - Climb and maintain 2,000 ft Above Ground Level (AGL) or above.
  - If departing other than runway heading, the left turn shall not exceed 30°.
- VFR aircraft at or below 2,000 ft AGL MUST fly runway heading until the coastal shoreline to turn in the northern direction and proceed along the beach.
- RY16 missed approaches MUST be stopped at 500 feet until crossing the RIDDLE transition.
- GPS (RNAV) RY16 Approach shall
  - HEAVY aircraft operations are not authorized unless coordinated with the CC and PSU.
  - Added an altitude crossing restriction fix (UAMLY in this study) for all aircraft to cross 3.7 NM from RY16 threshold at or above 1,280 ft (see Figure 4.11).

#### 4.4.2.7 UAM Operational Limits, CNS Requirements, and Flight Behavior

Operational limits for UAM aircraft and proposed CNS rules and obstruction clearances. Some of the defined elements of UAM operational limits requirements were defined based on the literature review, team's experience, and industry SMEs, as well as input from the FAA's guidance on the

caveats in usage of different equipment and settings. UAM flight behavior was emulated to replicate multiple descriptions of the flight profiles and characteristics like speed, motion patterns, etc., based on the findings in literature review. These elements were closely followed with addition of ATC separation are as follows:

- Commercial piloted VFR operations only.
  - If the weather conditions unexpectedly change to IFR, UAM aircraft are expected to either adhere to IFR rules or return to the point of origin.
- UAM aircraft cruising speed of 130 kts.
  - Vertical speed of 500 fpm for departure and 300 fpm for arrival.
- Flight phases shall occur in the following sequence: ground taxi, hover climb, transition, departure procedure, climb, cruise, descent, arrival procedure, transition, hover descent, ground taxi.
- UAM arrivals and departures will use the same route.
- PSU and UAM pilots will communicate intentions with each other for separation when climbing or descending at the vertiports.
  - Altitudes of flight shall conform to FAR Part 91.119, except when necessary for departure or landing, the minimum altitude over urban areas is 1,000 feet AGL and 500 feet AGL over rural areas.

CNS requirements are a less clear operational aspect to define as there are uncertainties in what equipment may be necessary for UAM operations. Based upon the literature review presented in Section 3 of this report. The following operational characteristics were derived. While RNP 0.1 is often mentioned in the studies, RNP 0.3 appeared to be more reachable with the currently existing equipment.

- Corridor radius shall be twice the required RNP accuracy (Prevot, 2020).
  - One-way corridor is 1,800 ft wide.
  - Two-way corridor is 3,600 ft.
- Vertical separation was defined to be 400 ft.
- Other capabilities shall include:
  - ADS-B In and Out.
  - Mode C capability.
  - Two-way voice communications.

#### **4.4.3 Simulation Environment Configuration**

This subsection discusses the configuration of the ATCT simulation environment to be used for the research team's experiments.

##### **4.4.3.1 Simulation Environment**

The simulations were conducted within a standard ATC Tower environment augmented for ATC Lab conditions. Each station has been set up for LC and GC positions. Both positions had access to the radar display, Airport Surface Detection Equipment (ASDE-X) display, electronic flight strip display, frequency switch panel, and runway crossing memory aid. LC position also had two timers available for wake turbulence separation timing on departures.

The KDAB ATCT environment was taken as a base for operational scenarios with UAM traffic simulation. To have the most realistic scenarios, the simulation utilized a view from the tower with

runways 7L/25R and 16. Runway 7R/25L was not visually accessible, but the traffic could be seen on the ATCT radar screen and ASDE-X screen. The traffic flow to that runway was simulated and automated to replicate the standard operations at KDAB. It was presumed to be operated by a phantom controller. Since the KDAB vertihub was situated in the northwestern corner of the airport, its structure was not visually accessible from the ATCT view; although, the UAM aircraft could be seen once they lift-off from the ground.

#### **4.4.3.2 Scenario Configuration**

There were two similar operational scenarios, where each was based on a standard operational day at KDAB. The first scenario represents a day of operations at KDAB with only conventional air traffic. Twenty-four aircraft were simulated during the 40-minute scenario. The second scenario included a combination of regular air traffic flow in and out of KDAB and prediction of traffic throughput for UAM operations. That scenario included 32 aircraft for conventional air traffic and 12 for UAM traffic for a 30-minute time span. Conventional air traffic followed the pre-programmed trajectories and inputs from a pseudo-pilot based on received ATC instructions. UAM traffic flow was mostly automated using the pre-programmed flight trajectories based on the corridor networks, but it also could follow the inputs for remote control from a pseudo-pilot.

The runway usage remained the same during the scenarios. The main runway staying active was 7L/25R, with occasional arrivals to runway 16 for LAHSO procedures. The aircraft arriving at runway 16 were Cessna 172 Skyhawks. They stopped before the runway 7L/25R intersection and typically turned into the ERAU ramp.

To better emulate UAM integration into the NAS, the UAM scenario also included three off-nominal conditions that the participants were assessed on:

- Handling a UAM emergency request to leave the corridor environment and proceed directly to the KDAB vertihub.
- Coordination for use of RIDDLE transition with CC/PSU while runway 16 is active.
- Protection of taxiing traffic from NASCAR Hangar and departing UAM aircraft.

These off-nominal situations were added to fully imitate the environment and possible complications that come with the addition of UAM traffic into active airports. The first two conditions allowed better assessment of the impact of UAM on LC management and organization, while the third condition was intended for understanding the GC part in UAM operations.

#### **4.4.4 Experimental Design**

To arrange and conduct the experiment for this study, the team has thought through different methodologies and metrics that may be measured, workload assessment tools, elements of the simulation environment that include roles, procedures (legacy and UAM-related), and instructions suitable for successful organization of the experiment. Once these elements have been discussed, developed, and set in place for the experiment, the team submitted an application to the ERAU Institutional Review Board (IRB) for their review and approval because the experiment included human subjects. Upon obtaining the approval from the ERAU IRB, participant recruitment began in parallel with the initial experimental set-up for the experiment. Once the desired (or close to desired) number of participants were recruited, the team scheduled and conducted a set of experiments outlined in the planning stage.

#### **4.4.4.1 IRB Review and Participant Recruitment**

The IRB application was a necessary step in preparation for the experiment with human subjects. Along with the IRB application online form, the submission included:

- Collaborative Institutional Training Initiative certificates for all the ERAU research study personnel.
- ATC study packet with relevant documents explaining fundamental phraseology for LC and GC, Pseudo-Pilot phraseology and input instructions, KDAB airport layout, list of airport location identifiers, and list of air carrier callsign identifiers.
- GC Performance Assessment sheet.
- LC Performance Assessment sheet.
- Demographic Survey Questionnaire.
- Pre-Experiment briefing script and presentation to raise participants' awareness about the significance and general course of the experiment.
- Post-Experiment briefing script to officialize the end of the experiment.
- Human Subjects Stipend Request Form.
- Informed Consent Form to ensure that human subjects' consent to the participation in the study.
- NASA TLX Survey with the instructions and questions that will be presented via the app.
- Recruitment email script used for participant search.

The IRB approval was granted to A36 WP3 Urban Air Mobility Studies on February 22, 2022. The submitted IRB documents may also be reviewed in Appendix B.

Once the team received the approval, participant recruitment began. The recruitment email was sent out to students of the ATM department, students who are participating in the ATM minor, and graduate students who have completed either within their ERAU Bachelor of Science degree. To increase the validity of the study's results, a pair of ERAU faculty with extensive real-world experience in the ATCT were also recruited. The participation requirements were as follows:

- Be at least 18 years old.
- Be an active student participating in Air Traffic Management degree/minor or a faculty member with previous Air Traffic Control experience.
- Have completed at least AT 315 (Introduction to Air Traffic Control Tower) or have previous experience in the ATCT.

The team was able to recruit 10 human subjects to participate in the experiment part of the study. Eight of them were students who satisfied all the requirements. Two of them were ERAU faculty members who satisfied the requirements and were able to participate in the experiment.

#### **4.4.4.2 Experimental Set-Up**

This section describes the simulation environment configuration and setup necessary for the simulation experiments performed.

##### *4.4.4.2.1 Lab Environment*

The lab environment was set to remain homogeneous throughout the experiment. The temperature and overall equipment set-up stayed the same during each simulation. Equipment set-up was as described in Section 4.4.3 of this report. Other environmental factors were thoroughly considered

before proceeding along with the course of the study. The simulations took place during the 1<sup>st</sup>, 2<sup>nd</sup>, or 3<sup>rd</sup> day of the week (i.e., Monday, Tuesday, or Wednesday). Participants' availability and willingness to attend were the primary factors in day pairings for experiment set-up, while environmental factors were of a secondary concern for scheduling purposes. This choice has been made to keep the relative homogeneity within the environment of the lab and in general, outside of the lab. As each participant had to undergo four simulations total, they were split in two days per participant. The times during which the simulations were conducted were similar for each pair of days.

#### *4.4.4.2.2 Experiment Simulation Positions Setup*

The ATCT simulation environment was limited to LC and GC positions because the clearance delivery position would not carry any significance within this study's scope. Both positions had assigned pseudo-pilots to emulate active flight operations. Two additional positions outside of ERAU's regular ATCT simulation setup were the CC position and PSU position, where both were fulfilled by the support personnel. Besides the standard duties of information coordination between facilities, CC's responsibility was to coordinate UAM corridor utilization and off-nominal scenarios with the PSU. The PSU position was assigned responsible for the oversight of UAM traffic flow and coordination of any off-nominal operations with the CC. As the PSU's role has not yet been fully established or defined by the FAA, the team augmented the available guidance from the FAA CONOP 1.0 and the literature review to replicate its functions, actions, and possible phraseology.

#### *4.4.4.2.3 Observing/Support Personnel*

In the progress of the simulations, the participants were observed by the specialized support personnel. The support personnel included SMEs and individuals with a considerable knowledge of ATCT operations and procedures. All of them are either part of the research team or faculty under the ATM department of ERAU. Their responsibility was to oversee the course of the experiments by noting useful details, elements of performance, situational awareness, unusual scanning patterns, distractions, and any other details that could help evaluate the environment and performance of the participants.

#### *4.4.4.2.4 Before the Experiment*

Once the recruitment process was completed, all participants were prompted to complete a Demographic Survey via Google Forms. The purpose of this survey was to gain a better insight on the selected participants taking part in the study. They also received an ATC study packet (mentioned in IRB submitted documents) to better familiarize themselves with the KDAB airport and refresh their memory on proper phraseology and other operational elements.

Before the initial assessment simulation, participants were randomly split into groups of two and given a briefing on the course of the research study, its significance, and what is asked of the participants within the scope of the experiment. After the briefing, the participants chose their starting position in the ATCT (i.e., GC or LC), and the first simulation began.

#### *4.4.4.2.5 Course of the Experiment*

Each participant was required to run three simulations total: one in both positions (switching midway through), one in GC position, and one in LC position. Pseudo-pilot and PSU/CC positions were filled in by the support personnel and were not evaluated within the scope of this study. The first simulation

included a scenario for runway configuration 7L/7R with an occasional 16 arrival for LAHSO but without any UAM traffic. It lasted around 40 minutes, where the participants were required to switch positions mid-simulation, complete the NASA Task Load Index (TLX) survey, and continue traffic management in their new positions. The second simulation included the same scenario for runway configuration 7L/7R with occasional 16 arrivals for LAHSO and UAM traffic arriving and departing to and from the KDAB vertiport. This simulation was completed twice, once in GC position and once in LC position.

Every participant completed three simulations. After each simulation (or part of the simulation) was finished, every participant completed the NASA TLX survey using an Apple iPad app. In between the simulations, every participant was given a 20-minute break to prevent effects of fatigue on performance evaluation. During that time, all shareable equipment was wiped to prevent the spread of COVID-19.

#### *4.4.4.2.6 After the Experiment*

Once the experiment was completed for a pair of participants, they proceeded to take their final NASA TLX survey. Once the surveys were completed, they attended a short debrief session that went over what they have accomplished within the course of this experiment. After the debrief was finished, the results were transferred to the study's database, and the participants were free to leave.

### **4.4.5 Metrics**

To measure the effects of UAM integration on human elements, the team used certain tools and metrics as part of this study. There were four elements: demographic survey, LC Assessment, GC Assessment, and NASA TLX survey. Each of them assisted to make a complete assessment of the study's sample data, particular insights of UAM integration into standard daily airport operations, and the workload that is imposed on ATC element because of it.

#### **4.4.5.1 Demographics Survey**

The demographics survey was used to collect basic demographic information for the sample of participants taking part in this study. It was split into three main sections: eligibility, basic demographics, and additional demographics that were based on whether the participant was a student or faculty. The survey was not extensive and would not require more than five minutes of time to complete (see Appendix B).

The eligibility section contained three controlling questions that allowed the participants to move forward if they met the requirement of participation. The eligibility requirements were as described in Section 4.4.4.1 of this report. If the participant did not satisfy all three of the required criteria, they could not continue with the survey or move forward with the experiment.

The basic demographics section allowed collection of information on gender, age, and ethnic background, as well as including a selection question on whether they were a student. If they chose yes, they were taken to the additional demographics section that was only pertinent to the student experiences within ERAU education program. If they chose no, they were taken to the additional demographics section that was only pertinent to faculty and their previous ATC experience.

The student participants' additional demographics section collected information about their major, education level, and to-date ATC experience (within ERAU Education Program). The faculty

participants' additional demographics section collected information on their previous ATC experience. Upon completion of that section, the participant submitted it to the A36 research team.

#### **4.4.5.2 Ground Control Assessment**

GC performance was assessed using GC Performance assessment sheet (see Appendix B). It was adopted from ERAU's ATC Program that commonly uses this evaluation instruction for the ATCT evaluations. Although, some alterations were adopted to include evaluation of UAM operational elements. The form used a point evaluation system and included 14 elements of evaluation with different weight of a point deduction based on the severity of that mistake to the safety of flight operations.

Three elements were weighted to have a 10-point deduction, if failed to fulfil:

- Protection of KDAB UAM Vertihub and UAM traffic.
- Use of procedures or phraseology when coordinating with PSU (especially protection for transitions like RIDDLE).
- Allow runway incursion to occur.

Two elements were rated at a 5-point deduction, if not fulfilled:

- Use of Approval Request (APREQ) for a runway 16 departure, when it is not active.
- High situational awareness of the environment/effective scanning techniques.

Two elements were rated at a 3-point deduction, if not fulfilled:

- Use of effective taxiing paths/routes, to include taxiing to and from the runways or crossing the runway (for example, allowing a nose-to-nose situation).
- Maintaining positive control of taxiing aircraft/arranging hold points along the route for efficient flow.

One element was rated at a 2-point deduction if an aircraft is delayed in crossing the runway for no reason.

Six elements were rated at a 1-point deduction, if not fulfilled:

- Maintain positive awareness of aircraft or vehicle IDs.
- Identify aircraft position at the time of first contact.
- Use of proper phraseology.
- Failure to use the word "taxiway" during runway crossing instructions.
- Indicate destination runway on the flight strip.
- Unorganized strip management on the flight progress strip board.

Each of the mistakes counted toward the final performance score, where each mistake resulted in point deductions. The sheet also contained a "Notes" section, where the evaluator could put down specific notes related to the controller's performance. This section was especially useful for explanation of UAM-related issues and elements of flawed performance, if any occurred. They were written down in a narrative form and further discussed in the Results section.

#### **4.4.5.3 Local Control Assessment**

Alternatively, LC performance was assessed using LC Performance assessment sheet (see Appendix B). It was also adopted from ERAU's ATC Program that commonly uses this evaluation instruction

for the ATCT evaluations. Compared to GC assessment, quite a few alterations were adopted to include evaluation of UAM operational elements in LC environment. This form used the same point evaluation system and included 17 elements of evaluation with different weight of a point deduction based on the severity of that mistake to the safety of flight operations.

One element was weighted to have a 10-point deduction if the controller failed to ensure proper runway separation. For example, an aircraft landed or took off over another or lost separation with UAM aircraft.

One element was weighted to have a 5-point deduction if the controller did not use proper procedures and phraseology when coordinating with PSU.

Two elements were weighted at a 3-point reduction, if not fulfilled:

- Inform CC/PSU of runway configuration change.
- Protect the UAM corridors via procedures or arrival/departure instructions.

Three elements were weighted at a 2-point reduction, if not fulfilled:

- Issue an alternative clearance to conventional air traffic when UAM exits the corridor environment.
- Issue a pattern entry point and use proper phraseology for VFR aircraft. Includes properly issuing a sequence of traffic.
- For Line Up and Wait (LUAW) procedures, inform LUAW aircraft of closest/cleared to land traffic, as well as inform runway 16 departure of traffic.

Ten elements were weighted at a 1-point reduction, if not fulfilled:

- Proper use of LUAW and Runway Crossing memory aids.
- Proper aircraft identification on initial contact.
- Proper take-off/landing clearance phraseology.
- Use key elements in phraseology, like “full length” or intersection name.
- Proper phraseology for runway crossing.
- Proper phraseology for aircraft exiting the runway.
- Maintain awareness about aircraft ID without repetitively asking their ID and location.
- Use proper strip marking.
- Unorganized strip board or scratch pad management.
- Efficient working flow without making aircraft wait too long.

Each of the mistakes counted toward the final performance score, where each mistake resulted in point deductions. The sheet also contained the same “Notes” section, where the evaluator could put down specific notes related to the controller’s performance. This section was especially useful for explanation of UAM-related issues and elements of flawed performance, as LC environment was more affected by the UAM traffic. They were written down in a narrative form and further discussed in the Results section.

#### **4.4.5.4 NASA TLX Survey**

NASA TLX (NASA, 2020d) assesses the workload for human subjects necessary for the subject to complete their assigned tasks using a human-machine interface. It can be presented on paper or online format within the NASA TLX application. Within the scope of this study however, it was given to the participants on an Apple iPad interface using a NASA published app (NASA, 2022).



The assessment splits workload into six different rating categories: mental demand, physical demand, temporal demand, performance, effort, and frustration level.

- Mental demand category assessed the demand of mental and perceptual activity, such as thinking, deciding, calculating, remembering, scanning, etc. It prompted the participant to think whether the task was mentally easy or demanding, simple or complex.
- Physical demand category assessed the demand of physical activity from pushing, pulling, turning, controlling, activating, etc. It prompted the participant to think whether the task was physically easy or demanding, slow or brisk, and restful or laborious.
- Temporal demand category assessed the part of the workload that comes from time pressure and rate and pace of the tasks.
- Performance category assessed the participants' perception on their own success with accomplishing the tasks and goals set by the research study. It prompts them to think about their satisfaction with how they performed the tasks.
- Effort category assessed the amount of mental or physical effort the participant had to achieve to achieve the level of performance rated in the previous category.
- Frustration category assessed participants' insecurity, irritation, stress, and annoyance levels during performing the task.

The assessment itself was split into two parts. First, the participants were presented with pairwise comparisons of two different categories to choose the element that had more impact on the total workload. There were 15 pair combinations for participants' choice. The second part included rating evaluation of the participants' experience for each of the categories on a scale from low to high or good to poor. Each evaluation had a separate scale, resulting in 6 different ratings.

After completing both parts, the participants were prompted to review their answers and submit the survey. The responses were then recorded in two different files, relevant to each part of the survey.

## **4.5 Experimental Results and Analysis**

Following the methodology presented in the previous section, the team conducted experiments on 10 participants under four roles: GC without UAM present, GC with UAM present, LC without UAM present, and LC with UAM present. This section of the report shall present the experimental results including TLX workload scores, LC/GC performance scores, and observations from the research team.

Next, the analysis subsection presents analysis of the results and discussion of their implications.

### **4.5.1 Results**

This subsection presents the experimental results. First, the demographics of the participants is summarized. Next, the participants' performance is assessed under the experiment scenarios without UAM and with UAM for the LC and GC positions. A discussion of the TLX and performance scores follows. Next, the TLX workload scores are presented.

#### **4.5.1.1 Demographic Survey**

As mentioned before, the researchers used the demographic survey to collect the basic demographic information and participants' experience level within the ATC domain. Responses to the first three control questions showed that all participants were eligible for participation in the experiment. Eighty percent of participants were male, and twenty percent were female. The gender statistics were

somewhat representative of the ATC industry in the United States, as well as the aviation industry in general (Zippia, 2022). Most participants were young – between 18-24 years old; though, one participant was between 25-34 years old, and two participants were older than 45 years old. Eighty percent of participants identified themselves as White or Caucasian, while 10% identified as Mixed and another 10% as Eastern Asian. Hence, the basic demographics showed that the sample was diverse and generally applicable to the ATC domain.

Additional information was collected from all eight student participants. Three quarters of them were earning a Bachelor of Science degree in Air Traffic Management as their study major, while one participant studied Aeronautical Science (i.e., pilot) and another one is earning a Master of Science degree in Aeronautics. Three quarters of the participants were also at a senior level of their degree progress, while one was a junior and one was a graduate student. All student participants have completed AT 315 – Introduction to VFR Tower, AT 401 – Advanced Terminal Radar Operations, and AT 405 – En-Route Radar Operations. In addition, three quarters of the participants have completed AT 406 – En-Route Non-Radar Operations and three fifth of the participants had experience with AT 415 – Advanced IFR Tower. Therefore, the team found that the participants were quite experienced, as collegiate students, in ATM and aware of implications of different events and the challenges that may occur within the ATCT environment.

For the faculty participants, their previous ATC experiences have been collected in lieu of classroom experience. All faculty participants have had the similar ATCT experience, where both have worked in ATCT and TRACON environments. In other words, they have achieved a high level of proficiency within the ATC environments most likely to be impacted by UAM operations via real-world experience.

#### **4.5.1.2 Ground Control Performance Assessments**

The GC position plays an essential part in the safe movement of aircraft, vehicles, and others on the airport movement areas at KDAB and the on-airport vertihub. The assessment of ATC performance in the GC position has shed some light on possible issues that may be evident either in the controller's behavior or vertiport operational success. For the no-UAM scenario, the scores varied from 95 to 100 points, with an average of 98.5. For the with-UAM scenarios, the range of scores increased from 84 to 100 points, with an average of 91.3. On average, there is a 7-point decrease from no-UAM to with-UAM scenario. Score distribution can be seen in Figure 4.13.

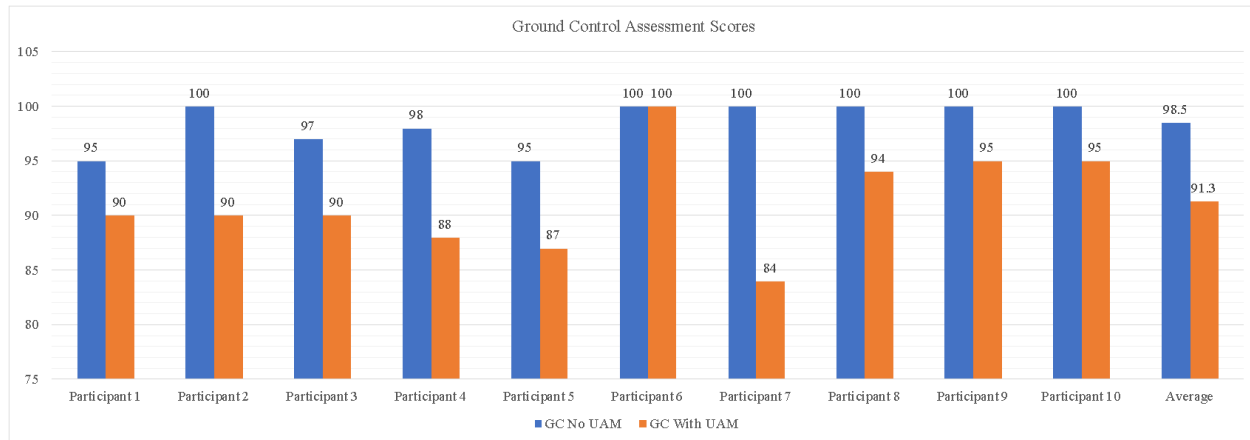

Figure 4.13. GC Assessment Scores.

One participant had no issues throughout their simulation runs regardless of the presence of UAM aircraft. Additionally, half of the participants had no imminent issues during their assessment in GC position without any UAM. Participants who did have issues in their no-UAM simulations appeared to have a runway crossing delay, missing elements of strip marking, poor knowledge of the airport, or improper use of runway crossing aid.

On the other hand, more participants had issues during their UAM scenario simulation. While most of them are UAM related, the participants also experienced some non-UAM-related issues that were not present in the first, no-UAM scenario. The comments are presented in Table 4.1, where some of these issues include:

- failure to protect taxiing aircraft from the overflying UAM emergency,
- failure to issue runway crossing or notify LC once the crossing was complete,
- over protection or under protection of the KDAB vertihub,
- issuing traffic for aircraft regarding UAM when not necessary,
- not issuing traffic for aircraft regarding UAM when necessary,
- not paying attention to the UAM aircraft ingress/egress, and
- lack of wake turbulence taxiing sequence awareness.

As per observations made of the participants' behavior during the UAM scenario simulation, some of them appeared more nervous or had more head movement than usual. One participant became visibly nervous once they received a RIDDLE transition request. The RIDDLE transition requires GC and LC approval, or disapproval, based on current traffic. The RIDDLE transition crosses taxiways and runway 16. One participant initially denied the operation. This appeared to be a categorical denial without a reason. The ATCT CC requested a time slot for the UAM RIDDLE transition, which was approved.

Table 4.1. Summary of Participant Evaluation in GC Position.

<b>ID</b>	<b>Scenario</b>	<b>Score</b>	<b>Issue</b>
1	No UAM	95	Did not maintain situational awareness while taxiing a Heavy which delayed runway crossing.
	With UAM	90	Was not able to protect runway 16 arrivals and UAM landing/departing.
2	No UAM	100	No issues.
	With UAM	90	Did not protect KDAB vertihub.
3	No UAM	97	Runway crossing delay at taxiway P; no runway assignment on a strip.
	With UAM	90	Did not protect the taxiing aircraft during the battery emergency.
4	No UAM	98	Poor knowledge of the airport.
	With UAM	88	Did not issue runway 16 crossing; LAHSO aircraft went past the intersection.
5	No UAM	95	Left 16/34 runway crossing aid on.
	With UAM	87	Over protection of the vertiport. More head movement for traffic scanning. Issued warning of UAM to the ac that didn't need it. Emergency equipment aboard the aircraft with battery issues.
6	No UAM	100	No issues.
	With UAM	100	No issues.
7	No UAM	100	No issues.
	With UAM	84	Did not protect UAM vertiport. Taxiing issues – turned B767 in front of C172. Taxied an aircraft from SheltAir with a departing UAM aircraft.
8	No UAM	100	No issues.
	With UAM	94	Did not discuss Alert 1/2 for the UAM aircraft with a battery issue. GC and LC did not notice that the UAM hasn't landed. Crossing runway or taxiway at 100 feet. Taxiing issues – turned B767 in front of C172
9	No UAM	100	No issues.
	With UAM	95	Did not notify LC once runway crossing was complete
10	No UAM	100	No issues.
	With UAM	95	Remained calm until RIDDLE transition request, then proceeded to say "UNABLE" without reasoning. Utilized 2-way taxiing on taxiway N. Good awareness on protecting the UAM emergency

### 4.5.1.3 Local Control Performance Assessments

LC performance assessment was more critical to the progress of this research study as this position on average has a larger workload impact during the UAM operational scenarios. It is further described in the NASA TLX Survey results section. The score distribution for the scenario with no-UAM was from 90 to 100, with an average score of 97.6. Though, for the scenario with UAM aircraft, the scores varied from 80 to 100, with an average score of 93.7. On average, there was a 4-point decrease from no-UAM to with-UAM scenario. The exact score distribution can be seen in Figure 4.14. Table 4.2 displays a summary of the participants evaluation in the LC position.

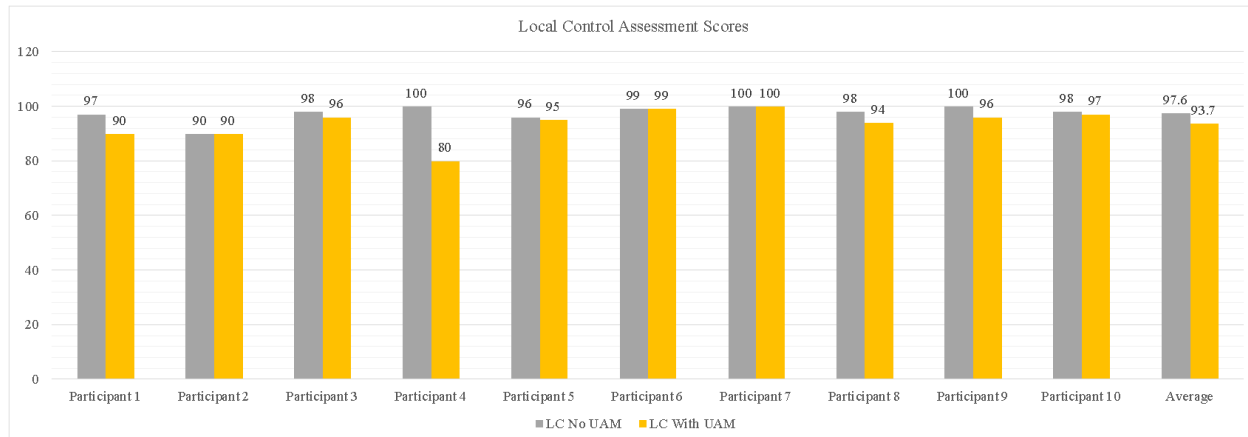

Figure 4.14. LC Assessment Scores.

Only one participant had no issues throughout both evaluations and only two participants had no issues during the no-UAM evaluation. Some of the common issues during no-UAM simulations included:

- Improper sequence of traffic,
- Proper phraseology for take-off clearance,
- Improper wake-turbulence separation,
- No heading assignment on departure for turbo-prop aircraft,
- No traffic advisories for traffic on 7L and 7R,
- Improper use of LUAW memory aid, and
- No switch to departure frequency.

While there were a lot of identified issues in the no-UAM scenario, the scenario which included UAM operations exposed even more issues. These issues were:

- Loss of separation between the conventional air traffic and UAM aircraft,
- LUAW with traffic on short final,
- Improper same runway separation for an arrival aircraft following a departure aircraft,
- Improper wake turbulence separation,

- Not treating the emergency UAM aircraft the same way a conventional aircraft would be treated during an emergency,
  - Failure to identify an Alert 1 or Alert 2 situation,
  - No information about emergency equipment on board,
- Improper use of LUAW memory aid, and
- No alternative clearance to the UAM aircraft leaving the corridor.

Even though a lot of identified issues pertained to the UAM operations, over half of the participants handled UAM operations well and protected the corridor environment during nominal and off-nominal situations. Similar to the GC evaluation, some participants seemed more nervous than usual, especially during off-nominal situations.

Table 4.2. Summary of Participant Evaluation in Local Control Position.

ID	Scenario	Score	Issue
1	No UAM	97	Did not properly sequence traffic. Did not say FULL LENGTH.
	With UAM	90	Aircraft lost separation with the UAM aircraft.
2	No UAM	90	Wake turbulence separation.
	With UAM	90	Aircraft lost separation with the UAM aircraft.
3	No UAM	98	Improper headings and no headings for the prop aircraft.
	With UAM	96	Great handling of UAM emergency but could have issued traffic to that UAM. LUAW issue with a heavy on a 4-mile final.
4	No UAM	100	No issues.
	With UAM	80	Runway separation not ensured when a Heavy landed and the preceding AC was departing. Wake turbulence was not applied for a small behind heavy departure.
5	No UAM	96	Did not time wake turbulence separation. No traffic issued for 7L and 7R, and no departure headings. A lot of coordination due to GC being a retired ATC.
	With UAM	95	Did not ask for emergency equipment on the UAM aircraft.
6	No UAM	99	Left LUAW on after the aircraft departed.
	With UAM	99	Go-around but used proper procedure. Left LUAW on after the aircraft departed.
7	No UAM	100	No issues.
	With UAM	100	No issues.
8	No UAM	98	Did not tell the aircraft to contact departure. No wake clocks. Good scanning.
	With UAM	94	Good job protecting the corridors. Did not issue alternative clearance to the UAM emergency. Did not tell aircraft to contact ground. Appeared nervous and mumbled to himself. Issued traffic to the aircraft overtaking the UAM emergency. Did not ask for Alert 1 or 2 for UAM emergency. Didn't start the clock. Restricted RIDDLE departure after RY 16 arrival.
9	No UAM	100	No issues.
	With UAM	96	Did not turn off LUAW memory aid. Selected the wrong memory aid for runway crossing. Sent an aircraft around during the UAM emergency for no reason.
10	No UAM	98	Requested LAHSO procedure for an air carrier (air carriers do not participate in LAHSO).
	With UAM	97	Issued UAM traffic to NAS arrivals. Issued possible wake turbulence alert to the UAM aircraft turning behind B737. Could not protect UAM corridors. Complained that UAM routes and operations restrict quick left turns for prop departures – slowing departures.

#### **4.5.1.4 Discussion of Assessments**

From the results, the following discussion provides insights from team members observing the experiments.

##### *4.5.1.4.1 Ground Control*

Some identified reasons for issues encountered during the GC Assessment were participant currency and proficiency level, KDAB airport knowledge, and understanding of how the UAM operations fit within the NAS.

Participant currency refers to the last time they have successfully applied their ATCT skills in the simulation or real-world environment. Participant proficiency refers to the kind of training they have received to date. Two participants were faculty (retired ATC); hence, they had the highest proficiency and currency. Two student participants studied outside of ATM department. One student pursued a bachelor's degree in Aeronautical Science and another one pursued a master's degree in Aeronautics. Their proficiency and currency were expected to be lower as their ATC experience was either not as high or somewhat dated compared to other participants. The remaining six students were deemed current and proficient in an ATCT environment.

Several of the participants had no knowledge or minimal knowledge of the KDAB airport layout or airport specific ATC procedures until they received their ATC study packet. The study packet included an airport map and the KDAB phraseology hand-outs; however, the researchers noted it is difficult for some participants to apply that knowledge without significantly more practice than was provided in this experiment. Lack of practice was evident in issues like slow taxiing, situational awareness, and runway crossing delays. Lack of KDAB UAM vertiport protection may be due in part to poor airport knowledge or comprehension of UAM vertiport protection requirements. Researchers noted a range of UAM vertiport protection measures on GC. Some participants did not protect for UAM operations and others applied very restrictive protection. The following two situations required UAM protection and were typically deficient with GC participants:

- a. GC participants needed to apply KDAB UAM restrictions to UAM traffic utilizing the RIDDLE Transition to NAS aircraft taxiing on Taxiway W which is near the KDAB vertiport.
- b. GC needed to consider restrictions on NAS aircraft taxiing on taxiway N for a UAM aircraft that declared an emergency for a low battery exited the UAM corridor and flew direct to the KDAB Vertiport.

Understanding of UAM operations was the least defined attribute but played the biggest role in UAM scenario assessments. Some participants were overly surprised by UAM aircraft appearance and performance. The standard operational constraints of UAMs seemed more confusing to the controllers when comparing the conventional NAS air traffic. While all the participants were given the same briefing and study packet, only four of them could appropriately handle both the UAM emergency and vertiport protection as a required of the GC during the performance assessment.

##### *4.5.1.4.2 Local Control*

The LC assessment revealed higher stress levels with UAMs. Inexperience or comprehension of the UAM operations and requirements seemed to have the biggest effects on the participants.

KDAB LC is complicated with parallel runways, crossing runways, significant mix of IFR and VFR traffic all flying within five miles of the airport. LC requires a high degree of situational awareness



because the aircraft are flying or are in take-off configurations. Researchers noted a range of UAM vertiport protection measures on LC. As on GC, some participants did not protect for UAM operations and others applied very restrictive protection. The following are areas where UAM protection was deficient on LC.

- a. LC participants needed to apply KDAB UAM restrictions and solutions to UAM traffic utilizing the RIDDLE Transition for NAS aircraft arriving RY16. The RIDDLE Transition crosses RY16.
- b. LC needed to consider restrictions on NAS aircraft arriving on RY7L for a UAM aircraft that declared an emergency for a low battery and wanted to exit the UAM corridor and fly direct to the KDAB Vertiport.
- c. LC needed to issue instructions to NAS aircraft initiating a missed approach on RY7L, to protect UAM corridors.

When no UAM aircraft were present in the airspace, most participants handled the air traffic correctly with only a few minor issues. However, in the simulations with UAM traffic flying to and from the KDAB vertiport, separation errors and lower situational awareness were exposed. One distinctive issue the participants had was protection of UAM corridors during the go-around situation. Depending on the aircraft's proximity to the touch-down zone, a go-around procedure would potentially compromise the safety of the UAM corridor environment.

On the other hand, some participants were very aware of the possible effects of the UAM emergency to the NAS traffic flow to RY7L. Some issued traffic, but no alternate instructions were needed to ensure separation. One participant (ATC retiree) issued a wake turbulence caution to the UAM emergency aircraft who passed behind a B737. There are implications for route changes during an emergency.

When a UAM aircraft leaves the corridor as part of an off-nominal scenario, it is supposed to be treated as a regular conventional aircraft. Controllers should issue traffic and safety alerts as needed to the UAM emergency aircraft and NAS aircraft. Minimum information (FAA JO7110.65 10-2-1) requires solicitation of certain items, such as pilot desires for emergency equipment, souls on board, etc. While the participants were aware of this ATC requirement, none of participants initiated the requirements of this order with the UAM emergency. It is possible they considered a low battery as minimum fuel because minimum fuel is not an emergency but merely indicates an "emergency situation" is possible (FAA JO 7110.65 Pilot Glossary). In addition, CC notified LC about the UAM emergency and pilots desires to fly direct to KDAB. However, when the UAM reported on the LC frequency, the participants did not inquire about any additional information or desires to have emergency equipment ready at the DAB vertiport. This is of a particular concern as the most common emergency scenario was battery issue, which could result in many possible outcomes, like in-flight fire, immediate aircraft stall, failure to safely land, etc. The UAM aircraft may require firefighting personnel, and Alert 1,2, or 3 situations. Participants in this simulation may be unaware of the particular needs of these new emerging aircraft and this highlights future required training.

There were other issues not related to UAM aircraft that were likely caused by higher perceived pressure levels in the LC environment. LC is responsible for safe transition from approach to a landing, LUAW procedures, same runway separation, wake turbulence separation, intersection departures, and IFR and VFR departure headings. These requirements all play a part in the

complexity of LC at KDAB. Without UAM aircraft, most issues were related to wake turbulence separation timing, usage of LUAW visual aid, and proper departure headings. They likely originated from participant's currency/proficiency, knowledge of the airport, and general situational awareness. However, the addition of UAMs seemed to intensify the pressure put on LC with the same or similar issues occurring. This may be a result of something new in their scan and thoughts of what to do next. Researchers noted that when the UAMs stayed in their corridors and NAS aircraft complied with ATC instructions there was minimal impact to ATC workload. As the researchers added issues, such as UAM requests to deviate from the corridor for an emergency, UAM approval requests for routes impacting NAS traffic, or NAS traffic making a missed approach, significantly increased perceived pressure on the LC.

#### *4.5.1.4.3 Local Control vs. Ground Control Score Distribution*

The Assessment sheets had a similar scoring system with most issues being equally weighted. On average, the GC Assessment score without UAM was 98.5, and with UAM, it was 91.3. For the LC Assessment, the average score without UAM was 97.6, and with UAM, it was 93.7. The score decrease for GC was a little over 7 points, and for LC – almost 4. The score for the scenario with no UAM was lower for LC compared to GC. Though, the results were expected due to the significant differences in the operating environments. On the other hand, during scenarios with UAM traffic, the average LC score was higher than the average GC score. This was a noteworthy finding as LC was assumed to have a more severe impact from UAM operations than GC. Probable causes for this finding were differences in the severity of occurred issues and the way the controllers handled them. The most common mistake for LC was failure to gather information from the UAM emergency, while the most common mistake for GC was failure to protect the vertiport. Their point deduction was different, as vertiport protection is of a higher importance. Other issues from LC or GC were not as severe with 1–5-point deductions. Hence, in combination with the harsher 10-point mistakes, it paved the way for a lower average score among GC distribution.

Human error had a considerable effect in point distribution as well. Since all participants have received the required training, they shall possess the skills necessary to manage air traffic safely and efficiently. Although, a lot of minor issues related to the loss of situational awareness were noted that may be ultimately attributed to human error. These are the actions that the participants would not have done otherwise, like leaving the LUAW sign on, wrong aircraft sequencing, or missed departure headings.

#### **4.5.1.5 NASA TLX Workload Survey**

While the Local and Ground Assessments were observations made by the support personnel, the NASA TLX Survey scores represent the actual workload experienced by each of the participants. Scores for LC and GC were separated to better differentiate between the scenarios and workload distribution within the same position.

One participant experienced the same workload regardless of the presence of UAM aircraft. Four participants had a lower workload score during the with-UAM scenario compared to the regular one, which the team believes can be attributed to the participant becoming more familiar with the simulation environment from the regular run. Five participants had a higher workload score during the with-UAM scenario. Figure 4.15 presents the NASA TLX workload scores for GC.

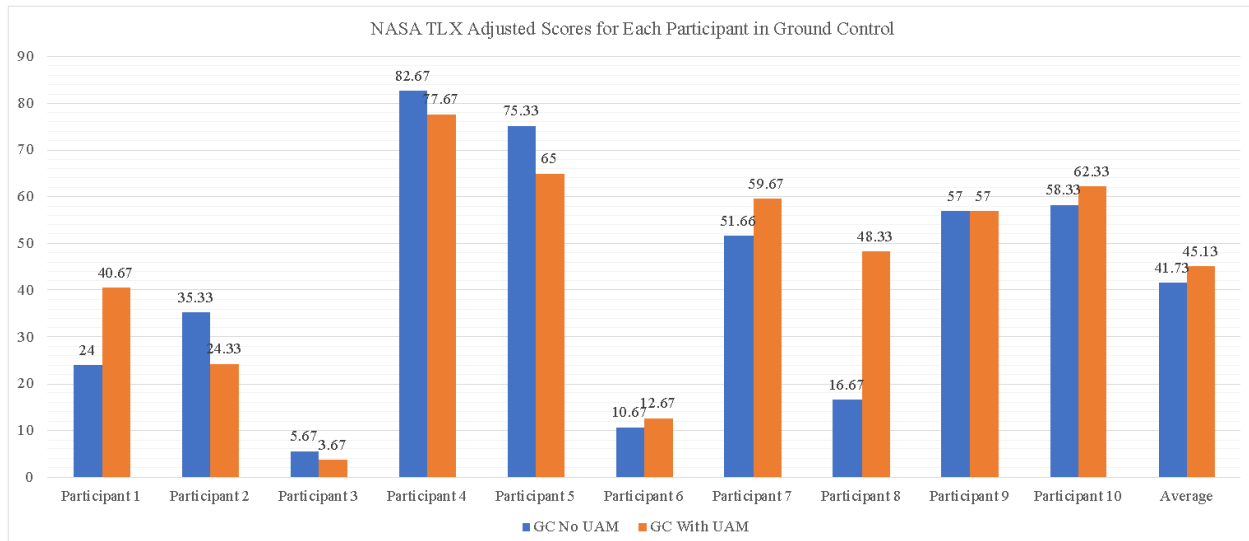

Figure 4.15. NASA TLX Adjusted Score for Each Participant in GC.

Moving onto the LC scores, three participants had an initial no-UAM score higher than the with-UAM one. All other participants have indicated an increase in their workload from the initial scenario to the with-UAM simulation. Figure 4.16 presents the NASA TLX workload scores for LC.

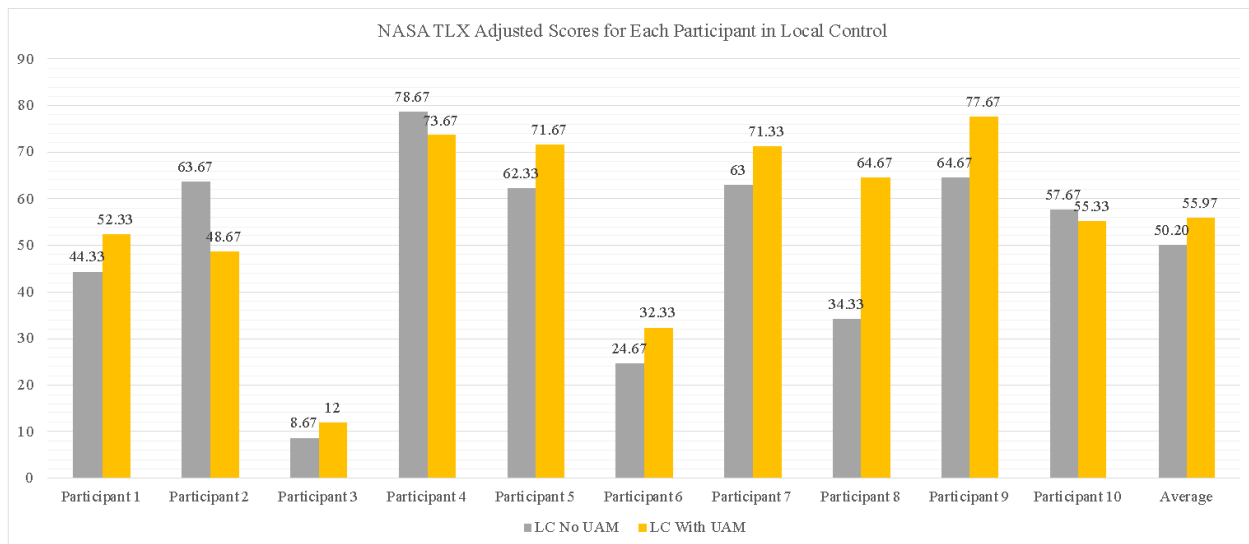

Figure 4.16. NASA TLX Adjusted Score for Each Participant in LC.

Analyzing the score distribution for both positions, there are a few observations and conclusions that may be drawn. If the initial score is higher than the following score, then the origin of workload for those participants has likely come from scenario anticipation, poor knowledge of the airport and procedures, and stress. Even though all participants have been thoroughly briefed on the experiment, and received a study packet for additional learning, lack of airport experience, anticipation of managing the traffic at a new airport, and general stress that comes from it might have boosted the initial workload for these participants. Hence, the second time around, they were more at ease and comfortable managing the traffic flow, as they were more familiar with the “way of things.”

If the initial score is lower, then it is likely that either the addition of UAM operations or signs of fatigue were impacting the score distribution. As the participants were completing all simulations in the same day, it is important to acknowledge that possible signs of early fatigue could impact the latter scores, even though there were 20-minute breaks in between the simulation runs. However, UAM operations could significantly impact the workload. GC had the task to protect the vertihub and ensure that the taxiing aircraft would be separated. Reviewing the assessment notes, some participants overprotected the vertihub, which is a clear indicator that this task was always in the participants' mind and could have added some pressure to their stress levels. LC had a task to protect the UAM corridors and emergency aircraft. While some have done a stellar job at separating UAM and non-UAM traffic, others have failed to understand their task pertaining to UAM operations.

**4.5.2 Analysis**

Observing the TLX and ATC performance assessment scores, there appear to be several noteworthy differences in scores. Figure 4.17 determines the statistical significations of the results, the team selected the Wilcoxon Signed-Rank test to determine if there is a significant difference between the means of two measurements from the same or related populations (Lowry, 2022). The analysis determines if there is a statistically significant change in TLX workload or ATC performance assessment between UAM and non-UAM scenarios and between LC and GC positions. The Paired t-Test could not be used for this analysis because of the data collected and their differences were not normally distributed as each, failed two normality tests, observations of histogram did not yield a bell curve-like plot and a Q-Q plot demonstrated skew discounting normality (Figure 4.18).

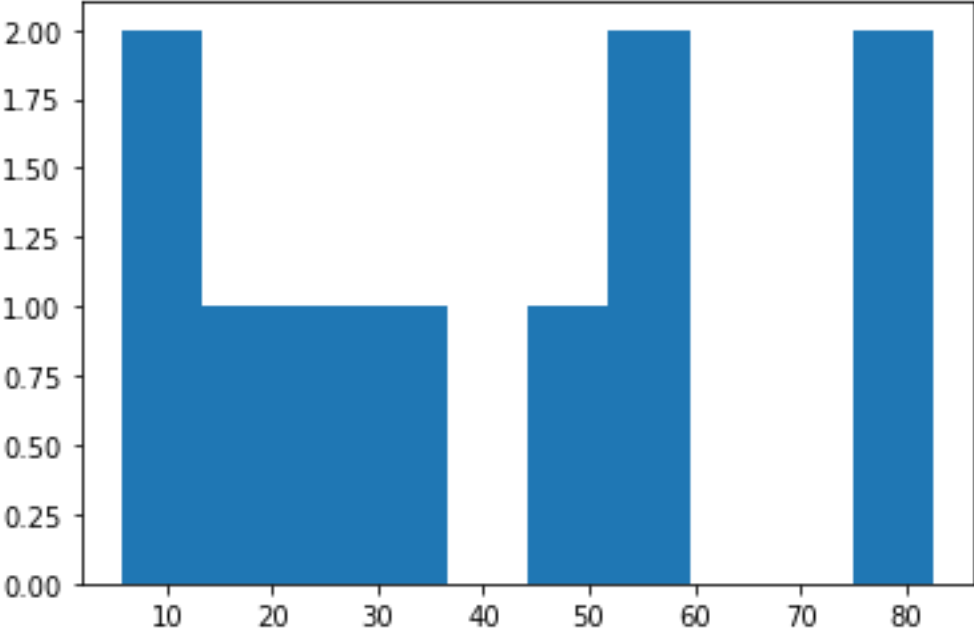

Figure 4.17. Sample histogram demonstrating lack of normality.

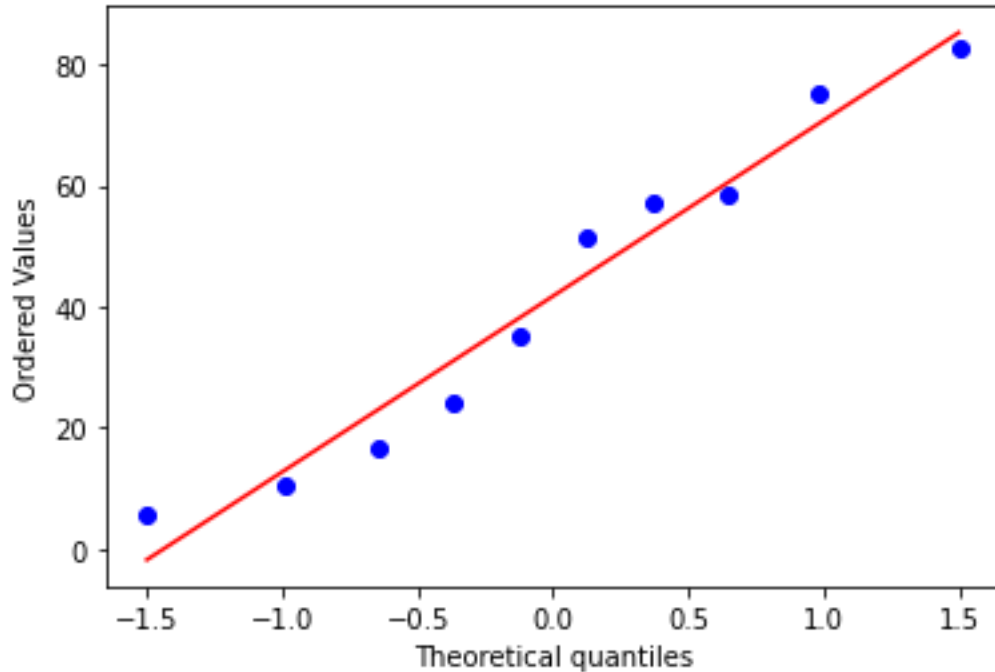

Figure 4.18. Sample Q-Q Plot demonstrating lack of normality (i.e., skew).

The research team selected this test as it provided a mechanism to compare measurements of workload or ATC performance scores between the different scenario configurations, i.e., GC without UAM, GC with UAM, LC without UAM, and LC with UAM. The team used the Wilcoxon test built into the Python library SciPy. When applying the test to two selected data sets from our results, a p-score is derived. A p-score of less than 5% (0.05) indicates that the difference in measurements between the two populations is statistically significant.

For workload and performance, respectively, the following pairs were evaluated:

- GC no-UAM vs. GC with-UAM
- GC no-UAM vs. LC no-UAM
- LC without UAM vs. LC with-UAM
- GC with-UAM vs. LC with-UAM

#### 4.5.2.1 Analysis of TLX scores

Table 4.3 presents the results of the Wilcoxon Signed-Rank Test for TLX Workload. From these results, insufficient evidence exists to support the conclusion that UAM’s presence impacts the workload of the participants with respect to the same position, i.e., the GC with-UAM vs. no-UAM and LC with-UAM vs. no-UAM scenarios the difference in workload was not significant enough to be statistically significant.

When UAM are present, the results showed LC workload to be higher than GC to a statistically significant degree.

Table 4.3. Analysis of TLX scores using Wilcoxon Signed-Rank Test.

	<b>p-value</b>	<b>p &lt; 0.05</b>
GC no-UAM vs. GC with-UAM	0.63529	No
GC no-UAM vs. LC no-UAM	0.08398	No
LC no-UAM vs. LC with-UAM	0.16016	No
GC with-UAM vs. LC with-UAM	0.01367	Yes

#### 4.5.2.2 Analysis of ATC Performance Scores

Table 4.4 presents the results of the Wilcoxon Signed-Rank Test in for ATC Performance. Two of the comparisons yielded significant results under this test. Both LC and GC positions showed a significant difference in controller performance when comparing their performance with-UAM vs. no-UAM.

Table 4.4. Analysis of ATC Performance using Wilcoxon Signed-Rank Test

	<b>p-value</b>	<b>p &lt; 0.05</b>
GC no-UAM vs. GC with-UAM	0.00742	Yes
GC no-UAM vs. LC no-UAM	0.66903	No
LC no-UAM vs. LC with-UAM	0.01755	Yes
GC with-UAM vs. LC with-UAM	0.23504	No

For the GC position, the mean score for ATC Performance without UAM was 98.5 versus a reduction in performance to a mean of 91.3 with UAM present. Likewise, for the LC position, the mean score for ATC performance without UAM present being 97.6 versus with UAM present being 93.7.

#### 4.5.2.3 Analysis Summary

- Experimental results and analysis showed that there is a statistically significant difference between the GC position vs. UAM operations in the LC position when UAM are present. Participants reported a higher workload for LC than GC under scenarios where UAM are present.
- Experimental results and analysis show a statistically significant difference in ATC performance for both GC and LC positions when comparing operations with and without UAM present. Participants scored lower performance scores with UAM are present.
- For all other cases where the p-value exceeded 0.05, the team cannot conclude any statistically significant differences are present.

#### 4.5.3 Recommended Experiment Improvements

The experiments conducted within this research were able to draw some conclusions; however, due to some logistics issues, there were some shortcomings of the experiments that we would like to address in future research.

**Number of Participants.** Our experiments included only 10 participants, which was less than desired. Statistical analysis techniques often require many more participants and/or measurements to work. Our small participant population limited the types and scope of our statistical analysis. The team had

difficulty recruiting participants toward the end of the academic term, which is when the ATCT Laboratory schedule permitted our experiments.

***Qualifications of Participants.*** One confounding variable of our experiment is the level of training and experience between our participants. Of our participants, two were retired ATCT controllers while the remaining participants were students with ATCT simulator experience. Ideally, active and retired controllers would be used; however, the research team did not have the resources to recruit a sufficient number of participants with such qualifications.

***Coordination of Academic Resources.*** The greatest challenge for setting up and conducting the experiments in the ATCT Laboratory, which is designated for academic use. Its availability put the research team into the later half of the academic term, which was also the busiest time of the academic year for our students.

## **4.6 Recommendations for UAM/NAS Integration**

Based upon the research findings from the literature review, experimental design, and experiment execution, this section provides recommendations for UAM/NAS integration.

### ***4.6.1 The minimum system, operational, and procedural requirements necessary to enable UAM integration***

The research team sought to identify the operational and procedural requirements required to integrate UAM to consider its impact on the NAS. This section summarized the recommendations for UTM constraints, NAS constraints, altitudes, velocities, automation, and regulations.

#### **4.6.1.1 Constraints/Assumptions**

- Low altitude airspace (ground to 400 ft AGL) is designated as sUAS airspace, UAM operates at or above 500 AGL in or out of UAM corridors, depending on the mission and NAS traffic. (Constraint, Section 4.3.2.1)
- UAM corridors are three-dimensional routes, designed to safely segregate UAM traffic from NAS traffic without tactical ATC separation or traffic advisory services. (Assumption, Section 4.3.5.2)
- Initially, UAM corridors should be in operation during VFR only, but UAM should be capable of IFR flight in the NAS. (Constraint, Section 4.4.2.7)
- The operational altitudes for UAM should be between 500 and 1000' AGL (FAR 91.119) within 5 miles in the vicinity of the airport. (Assumption, Section 4.4.2.7)
- UAM arrivals and departures may use the same route. (Assumption, Section 4.4.2.7)
- UAM corridors connect vertiports pairing or exit and entry routes into airports. (Assumption, Section 4.3.2.2)
- UAM corridors should be named similar to STARs and SIDs and published, providing UAM pilots and PSUs with aircraft and pilot operating requirements, routing, obstructions, MSA (minimum safe altitude), navigational information, and ATC frequencies. (Constraint, Section 4.4.2.4)

#### **4.6.1.2 Recommendations**

- UAM corridors and on airport vertiports need to be designed with ATCT SME personnel input to mitigate a wide range of ATC issues surrounding an aerodrome (e.g., IAP procedures,

VFR traffic patterns, ATC SOP, and other local area considerations), UAM operators, pilot groups, airport personnel, and other interested parties. (Recommendation, Section 4.4.2)

- Local ATCT SOPs will need adjustments based on the UAM corridors. (Recommendation, Section 4.4.2)
- PSUs may be required to APREQ specific corridor operations or airport operations that impact NAS traffic with ATC. The ATC coordinator will approve or disapprove these UAM departure/arrival APREQs. (Recommendation, Section 4.4.5.2)
- PSU should engage in strategic conflict resolution and traffic deconfliction for participating UAM aircraft. (Recommendation, Section 4.3.2.1)
- PSU and UAM pilots will communicate intentions with each other for separation when climbing or descending in UAM corridors or at the vertiports. (Recommendation, Section 4.4.2.7)
- PSU must transmit instructions regarding taxi/takeoff authorization and departure sequence to UAM. (Recommendation, Section 4.3.2.1)
- PSU and UAM operators are responsible for UAM conformance and performance monitoring, and immediately inform ATC of irregularities. (Recommendation, Section 4.3.2.5)
- Data sharing for UTM and NAS aircraft shall ensure that all stakeholders are informed of UTM and NAS operations. The data would be transferred using FAA-NAS data exchange protocols. (Recommendation, Section 4.3.2.1)
- Standard Vertical speeds identified for take-off and landing were respectively 500 ft/min and 300 ft/min. The Approach and Departure speeds determined were 500 ft/min vertical and 45 to 130 kts horizontally. Cruise speeds should be 130 kts. Stall speed was identified to be 73 kts. (Recommendation, Section 4.3.2.4)

Table 4.5. Standard Vertical Speeds.

<b>Flight Phase</b>	<b>Vertical speed (fpm)</b>	<b>Horizontal speed (kt)</b>
Approach / Departure	<u>500</u>	<u>45 – 130</u>
Cruise	<u>N/A</u>	<u>130</u>
Take-off	<u>500</u>	<u>N/A</u>
Landing	<u>300</u>	<u>N/A</u>
Stall	<u>N/A</u>	<u>73</u>

- Digital Flight Rules (DFR) automation systems will create and execute flight plans, while human supervisors will analyze irregularities and set limits and priorities for automated aircraft. (Recommendation, Section 4.3.2.5)
- The 14 CFR Part 107 & Part 135 are the primary regulatory documents assumed to serve as the foundation for UTM and UAM operations. (Recommendation, Section 4.3.2.6)

#### ***4.6.2 The Communication, Navigation, Surveillance (CNS) requirements/best practices necessary for UAM integration***

The CNS requirements/best practices recommendations are necessary elements to be determined for UAM integration.



- Like USS, PSUs will report intentions, messages, and locations and receive notifications about UTM airspace and operations using the FIMS. (Recommendation, Section 4.3.3.1)
- UAM aircraft should use the FIMS to communicate vital safety procedures, which include traffic location, DDC updates, weather data, obstacles, flight paths, and destination information. (Recommendation, Section 4.3.3.1)
- PSUs will serve as the primary communication method for all UAM operators, within UAM corridors and at vertiports. However, if UAM aircraft leave the UAM corridor, prior to the exit fixes, they shall contact ATC on the appropriate frequency. (Recommendation, Section 4.3.3.1)
- Unless an emergency exists, communication between ATC and the UAM aircraft will not be required. UAM aircraft will be equipped with a WAAS-enabled GPS to perform operations. (Recommendation, Section 4.3.3.2)
- For more advanced accuracy levels of navigation for UAM aircraft, a multiple-sensor fusion system with three or more sensors may be required. (Recommendation, Section 4.3.3.2)
- A GNSS fused with EO/IR sensors technology is one option for improving precision during all flight phases. (Recommendation, Section 4.3.3.2)
- LAAS and WAAS system may provide better precision in low-level airspace navigation. (Recommendation, Section 4.3.3.2)
- The corridor’s navigation specifications under PBN should be set to 2XRNP. (Section 4.3.3.2)
- Based on FAA (2016) a RNP of 0.3 provides adequate safety and performance for terminal environments and rotorcraft operations in en-route. (Recommendation, Section 4.3.3.2)
- A corresponding radius of 1,800 ft and a one-way corridor and two-way corridor of 3,600 ft and 7,200 ft respectively may satisfy the RNP 0.3 requirement. (Recommendation, Section 4.3.3.2)

Table 4.6. Required Navigation Performance (RNP).

<b>Corridor</b>	<b>RNP</b>	<b>Radius</b>	<b>One-way corridor</b>	<b>Two-way corridor</b>
2xRNP	0.3	1,800 ft	3,600 ft	7,200 ft

- UTM surveillance will be sustained by PSU. It should be planned to use a combination of ground, airborne, and satellite-based infrastructure. (Recommendation, Section 4.3.3.3)
- The main data exchange will occur within PSU networks shared with USSs, SDSPs, the FAA, and other stakeholders with access. (Recommendation, Section 4.3.3.3)
- ATC will not be involved in UAM aircraft surveillance within corridors that uses data sharing of operational intent, Remote ID, and supplemental information between PSU, USSs, SDSPs and other stakeholders. (Recommendation, Section 4.3.3.3)
- UAM pilots are required to turn on required transponders and establish two-way radio communication with ATC when departing the UAM corridors, prior to exit fixes, for

emergencies, deviations from weather, or other circumstances. (Recommendation, Section 4.3.3.3)

- To achieve safety and security during UAS integration into the NAS, pre-installed remote IDs are used to broadcast identification, location, altitude, velocity, etc., and should be available to ATC if desired. (Recommendation, Section 4.3.3.3)
- In Class B, C, and D airspace, ADS-B with a low-power TCAS should be sufficient for UAM operations. (Recommendation, Section 4.3.3.3)
- To maintain DAA procedures in Class E and Class G airspaces, radar and sensor systems shall suffice. (Recommendation, Section 4.3.3.3)
- PBN principles, sensors, and PSU network data exchange will be used to assure separation. (Recommendation, Section 4.3.3.4)
- Three separation layers are expected to apply to ODM aircraft, a multi-layer strategy, separation assurance and collision avoidance. (Recommendation, Section 4.3.3.4)

Table 4.7. Approximate Separation Criteria.

<b>Separation</b>	<b>Vertical</b>	<b>Longitudinal</b>	<b>Lateral</b>
UAM-Cargo/UAM	250 ft	250 ft	TBD
UAM-VFR	4000 ft	450 ft	¼ mile (class c), ½ mile (class b)
UAM-IFR	1000 ft	2 miles	3 miles
UAM-AFR	500 ft	½ mile	*BOS

\*Based on operating speed

- Flight planning shall be the responsibility of PSUs. Fleet operator would submit to the PSU a proposed operations plan that includes a flight path. (Recommendation, Section 4.3.3.5)
- UAM shall use ADS-B In and Out, Mode C transponder, and two-way voice communication within UAM corridors and at vertiports. (Recommendation, Section 4.1.2.7)
- Departure and arrival separation should be 60 seconds (can be reduced to 45 seconds according to Bosson and Lauderdale (2018)). (Recommendation, Section 4.4.2.7)
- Based on the planned altitude, the aircraft should climb from that position to the above-mentioned altitude at approximately 900 ft/min, meaning the aircraft would reach at least 500 ft one minute after take-off. Upon reaching the desired altitude, the aircraft enters cruise flight at the speed that maximizes its range with the capability of climb at 500 ft/min. The descending path will depend on the aircraft type before entering the 30-second hold over the landing area for additional clearances. A related requirement that was added to such execution is to have 20 minutes of cruise reserve. Figure 4.19 summarizes a UAM mission profile. (Recommendation, Section 4.3.3.5)

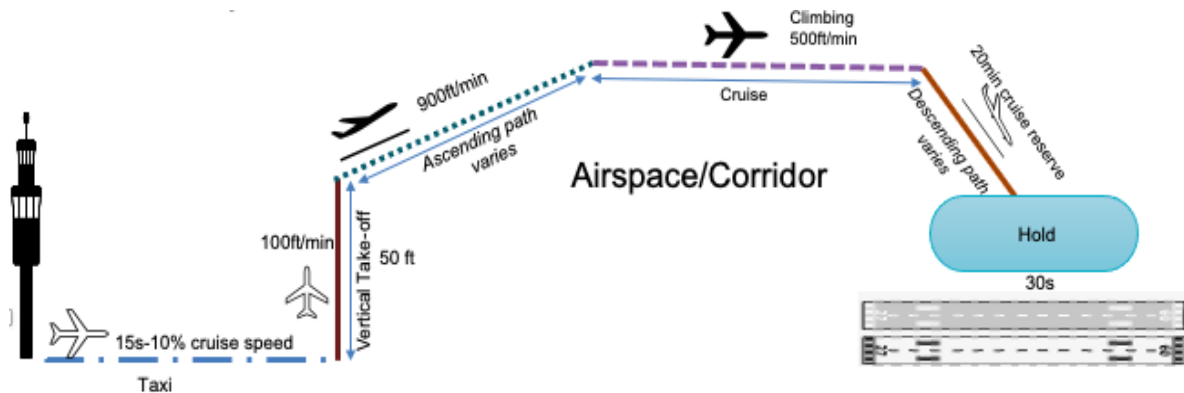

Figure 4.19. UAM mission profile.

#### 4.6.3 *The infrastructural requirements necessary to support UAS integration into NAS (including terminal environments)?*

A substantial amount of infrastructure must be built and installed to enable UAM operations, in addition to the aircraft, procedures, and airspace planning that are required.

- The necessary infrastructure features include vehicle-to-vehicle communication, enhanced situational awareness tools, air-to-air and air-to-ground data exchange, and communication links. (Recommendation, Section 4.3.5.1)
- Mode-C multilateration, ACAS-X, 5G capabilities, advanced Doppler Ranger Gating Range, infrared sensing, bistatic radar, and acoustic detection constitute the required ground infrastructure. (Recommendation, Section 4.3.5.1)
- UAM Corridors will serve as the supporting concept where a PSU controls flight separation along predetermined pathways. (Recommendation, Section 4.3.5.2)
- To avoid conflicts and spread awareness of new procedural norms, flight scheduling will handle flight separation in the UAM corridors primarily handled by airline operations and coordinated with the PSU. (Recommendation, Section 4.3.5.2)
- The Corridors will be connecting major local attractions and airport and the majority will be outside of or below controlled airspace. (Recommendation, Section 4.3.5.2)
- The corridor pattern changes depending on runway configuration with a two-way traffic within corridor. (Recommendation, Section 4.1.2.2)
- To evaluate altitudes that should govern infrastructure height, flight altitudes need to be evaluated to minimize the visual impact and increase visual acceptance. (Recommendation, Section 4.3.5.3)
- With AAM corridors, the flight paths should become more routine and less unsettling to the public. (Recommendation, Section 4.3.5.3)
- Passengers could use eVTOLs to connect nearby vertiports and airports, such as tourist attractions and major hubs to relieve the congestion on the highways and within urban environments. (Recommendation, Section 4.3.5.4)

- Interim vertiport design requirements are specified in “FAA Engineering Brief No. 105, Vertiport Design” (FAA, 2022).
- Table 8 provides a summary of the vertiport configuration used for our simulations. It was designed prior to the “FAA Engineering Brief No. 105, Vertiport Design” (FAA, 2022) release.

Table 4.8. Vertiport Configuration (Case of KDAB-MCO).

Placements	Dimensions	Elements
Vertipad	27,890 sq ft	6 parking locations – 60,000-80,000 sq ft
Vertihub – DAB and MCO	–	3-6 aircraft at a time
Vertistop	–	All other attractions

- UAM Training is not sufficient for the typical commercial pilot. Typical training is fixed wings or helicopters. It does not include eVTOL aircraft and items such as battery usage, quick turn arounds, and landing at a vertiport. (Recommendation)
- The degree of automation shall not affect pilots’ readiness to fly a plane in a shared airspace. The supply of UAM pilots will be essential to the long-term viability of the industry as more pilots retire and urban air mobility (UAM) develops. (Recommendation)

#### 4.6.4 Existing strategies to coordinate non-segregated operations between the UAM and non-UAM air traffic

To guarantee a safe UAM integration into the NAS, the coordination of segregated and non-segregated airspace elements between UAM and non-UAM air traffic needs to be addressed along with some strategic recommendations.

- When flying near non-UAM aircraft, pilots of UAM aircraft must request permission from the local ATC to operate. (Recommendation, section 4.3.6)
- Combining DDC and 4D RNP systems could lessen traffic issues with non-UAM aircraft and eliminate the need for ATC approval. (Recommendation, section 4.3.6)
- A UTM-like system that uses designated airspace, routing, and constant deconfliction may be used to separate UAM aircraft from traditional aircraft. (Recommendation, section 4.3.6)
- UAM vehicles could fly around or below the approach area of traditional aircraft near busy commercial airports. (Recommendation, section 4.3.6)
- AFR flights can settle conflicts in non-segregated airspace even without having to adhere to designated paths or corridors by using automated prediction principles and tactical cooperation. (Recommendation, section 4.3.6)
- UAM and traditional aircraft could utilize the same airspace for the flights. (Recommendation, section 4.3.6)
- Although DFR operations can be safely integrated into the same airspaces, DFR aircraft must still yield to aircraft flying under different flight rules. (Recommendation, section 4.3.6)
- For nominal operations, UAM will be separated from conventional air traffic and bound to operate within corridors. (Recommendation, section 4.3.6)

- For off-nominal operations, outside of corridors and UAM non-conformant with flight plan, PSU shall notify ATC in case UAM departs corridor. (Recommendation, section 4.3.2.2)
- In case of emergency, UAM shall exit corridor and land in safe location with PSU/ATC coordination. (Recommendation, section 4.4.3.2)

## 4.7 Conclusion

This conclusion section shall wrap up the technical report by (a) summarizing key findings by research question, and (b) highlighting proposed future work.

### 4.7.1 Key Findings

This subsection summarizes the key findings of the research team. The lessons learned are organized by research question.

Q1: What timelines for UAM/AAM capabilities are proposed by academia, industry, government, or other relevant stakeholders?

- An EASA study reviewed within the literature survey predicts 2025 for market entry with 2030 being the earliest for autonomous operations.
- EASA proposed a comprehensive new regulatory framework for operating air taxis in cities. Manufacturers of vertical take-off and landing (VTOL) aircraft have worked with EASA in developing regulations since 2019, a representative from EASA told *Avionics*. The proposed rules are open for public consultation until September 30. Following any necessary revisions, the European Commission will review EASA's regulatory framework in 2023 before deciding.
- EASA published the Notice of Proposed Amendment (NPA) on June 30, including recommendations for creating new amendments as well as updating existing regulations in the EU. Key areas of focus in the NPA are airworthiness certification for unmanned aircraft systems (UAS), and operational requirements for manned VTOL aircraft.
- From the literature review, most sources reported market maturing being reached by 2030 or later 2030s. See also, the A36 Work Package #1's report's discussion on the UAM market's timeline for deployment.

Q2: What are the minimum system, operational, and procedural requirements necessary to enable UAM integration?

- As a minimum, the requirements listed in and 14 CFR § 91.131 – Operations in Class B airspace. This will require adjustments to the FAR to enable PSUs to issue clearances into the airspace, as long as they are within the established corridors.
- EASA requires a certificate for UAS operators. This should be an operational requirement. A current commercial pilot certificate would be appropriate for UAM operators (certificate type is TBD).
- All routes, altitudes, speeds, frequencies to be used within corridors should be published similar to the current approach plates.
- Class B, C and D rules would need to be amended for UAM operations. For example, currently pilots are required to establish two-way communication with ATC (FAA JO 7110.65 7-8-4). Another example, Class C services (FAA JO 7110.65 7-8-2) lists sequencing

of aircraft to the primary airport, mandatory traffic advisories and safety alerts. These would need to be amended for UAM corridors.

Q3: What CNS requirements/best practices are necessary for UAM integration?

- Two-way radio requirement, transponder, IFR capabilities for pilot and aircraft.
- Controller Pilot Data Link Communications may be a solution to communication of intent

Q4: What is the impact of UAM integration on air traffic controller workload?

- Experimental results and analysis showed that there is a statistically significant difference between the GC position vs. UAM operations in the LC position when UAM are present. Participant reported a higher workload for LC than GC under scenarios where UAM are present.
- Experimental results and analysis show a statistically significant difference in ATC performance for both GC and LC positions when comparing operations with and without UAM present. Participants scored lower performance scores with UAM are present.

Q5: What are the infrastructural requirements necessary to support UAS integration into NAS (including terminal environments)?

- The FAA Engineering Brief. No 105, Vertiport Design (FAA, 2022) defines interim requirements for vertiport design, which should be followed including the infrastructure requirements therein.
- It was recognized that the specifics of UAM corridor design, pattern, and operation would vary on an airport-by-airport basis, based on a team of SMEs, aviation professionals, and airport users

Q6: What strategies exist to coordinate non-segregated operations between the UAM and non-UAM air traffic?

- A letter of agreement (LOA) would be necessary between the ATC facility and the PSU providers, including all stakeholders involved in UAM operations. This LOA would specify when and how non-segregated operations would be allowed.
- UAM corridors and on airport vertiports need to be designed with ATCT SME personnel input to mitigate a wide range of ATC issues surrounding an aerodrome (e.g., IAP procedures, VFR traffic patterns, ATC SOP, and other local area considerations), UAM operators, pilot groups, airport personnel, and other interested parties.
- Local ATCT SOPs will need adjustments based on the UAM corridors.

Q7: What are recent industry advancements toward UAM integration globally?

- The EASA studies (EASA, 2021) could be used as a template. During a recent EASA meeting (EASA, 2022), they defined three categories: Open category, which is low risk and no pre-approval required. This would be more like the person buying a drone from a big-box store; the second category with increased risk was Specific, which would require approval to fly from the national aviation authority; final category is the Certified category, which is essentially what the team was demoing in the simulations. These are limited to altitude and weight and require a license to operate.

Q8: What factors influence vertiport infrastructure design and planning?

- Community buy-in
- Availability of space on the airport
- Proposed locations
- Cost
- Noise considerations
- Number of aircraft to accommodate

#### ***4.7.2 Recommendations for future work***

The research team proposes the following future work to follow-on this research study.

- Develop an airspace model that can accommodate routes and procedures from city-pairs such as KDAB to KMCO.
- Recruit students earlier within the academic term with better communication of incentives of participating (e.g., a small stipend).
- To provide more validity to the project, the team must be able to use active controllers or be able to recruit retired controllers. This is the only way to provide valid feedback and suggestions in support of or against the project
- Look at operations at busier airports, such as Orlando.
- With FAA guidance and concurrence, develop specific corridor requirements for operations, size, altitudes, etc.
- Location of On-Airport Vertiports to ensure security and ease of usage.

## 4.8 References

- Aerospace Testing International. (2021, May 5). *The technical challenges still to be solved before eVTOLs can become air taxis*. Aerospace Testing International.  
<https://www.aerospacetestinginternational.com/features/air-taxi-analysis.html>
- Air Traffic Control Association. (2021). *A Future-Ready Framework For NAS Modernization*.  
[https://issuu.com/atca\\_org/docs/blue\\_sky\\_initiative\\_e-book\\_-\\_6\\_-\\_final\\_-\\_single\\_pa](https://issuu.com/atca_org/docs/blue_sky_initiative_e-book_-_6_-_final_-_single_pa)
- Airbus. (n.d.). Urban air mobility. <https://www.airbus.com/innovation/zero-emission/urban-air-mobility.html>.
- Alcock, C. (2020, February 7). Asia-Pacific stakes claim to place in urban air mobility revolution. Aviation International News. <https://www.ainonline.com/aviation-news/aerospace/2020-02-07/asia-pacific-stakes-claim-place-urban-air-mobility-revolution>.
- ANSI. (2020, June). Standardization Roadmap for Unmanned Aircraft System.  
<https://www.ansi.org/standards-coordination/collaboratives-activities/unmanned-aircraft-systems-collaborative>
- Antcliff, K. R., Moore, M. D., & Goodrich, K. H. (2016). Silicon Valley as an early adopter for on-demand Civil VTOL Operations. 16th AIAA Aviation Technology, Integration, and Operations Conference. <https://doi.org/10.2514/6.2016-3466>
- Antcliff, K., Borer, N., Satorius, S., Saleh, P., Rose, R., Gariel, M., Oldham, J., Courtin, C., Bradley, M., Roy, S., Lynch, B., Guiang, A., Stith, P., Sun, D., Ying, S., Patterson, M., Schultz, V., Ganzarski, R., Noertker, K., ... Ouellette, R. (2021). *Regional Air Mobility: Leveraging Our National Investments to Energize the American Travel Experience*.  
<https://ntrs.nasa.gov/citations/20210014033>
- Arellano, S. (2020). A Data- and Demand-Based Approach at Identifying Accessible Locations for Urban Air Mobility Stations. Technical University of Munich.  
[https://www.bgu.tum.de/fileadmin/w00blj/msm/theses/Arellano\\_2020.pdf](https://www.bgu.tum.de/fileadmin/w00blj/msm/theses/Arellano_2020.pdf).
- Atkins, E. (2021). *What aviation functions require automation (pilot aids) and/or autonomy (with decision authority) to achieve UAM (AAM) Maturity Levels 2 and 4?* (pp. 1–5). NASA/University of Michigan.  
[https://nari.arc.nasa.gov/sites/default/files/attachments/atkins\\_AAM\\_panel.pdf](https://nari.arc.nasa.gov/sites/default/files/attachments/atkins_AAM_panel.pdf)
- Bhadra, D., & Lukacs, M. (2021). *Advanced Air Mobility: Meeting with A.41 & A.42 Research Groups of ASSURE*.
- Bijjahalli, S., Sabatini, R., & Gardi, A. (2019). GNSS Performance Modelling and Augmentation for Urban Air Mobility. *Sensors*, 19(19). <https://doi.org/10.3390/s19194209>
- Blain, L. (2021, February 9). *Joby Aviation agrees on eVTOL certification class with the FAA*. New Atlas. <https://newatlas.com/aircraft/joby-aviation-agility-prime-g1-certification/>
- Boddupalli, S.-S. (2019, August 1). Estimating demand for an electric vertical landing and takeoff (eVTOL) air taxi service using discrete choice Modeling. SMARTech Home.  
<https://smartech.gatech.edu/handle/1853/61811>.



- Booz Allen Hamilton. (2018a). *UAM Market Study - Technical Out Brief* (p. 445). NASA. <https://ntrs.nasa.gov/search.jsp?R=20190000517&hterms=screening+mass+screening+mass+Community+based+school+based+work+place+hypertension+high+blood+pressure+diabetes+diabetes+mellitus+high+blood+glucose&q=Ntx%3Dmode%2Bmatchall%26Ntk%3DAll%26N%3D0%26No%3D>
- Booz Allen Hamilton. (2018b). *Final Report Urban Air Mobility (UAM) Market Study* (Issue November). <https://ntrs.nasa.gov/api/citations/20190001472/downloads/20190001472.pdf>
- Bosson, C. S., & Lauderdale, T. A. (2018, June 24). Simulation Evaluations of an Autonomous Urban Air Mobility Network Management and Separation Service. *Aviation Technology, Integration, and Operations Conference*. <https://doi.org/10.2514/6.2018-3365>
- CAAM. (2020a). *Advanced Air Mobility Comes to Vancouver: Vol. Fall*. [http://evtol.news/\\_\\_media/news/NEXA-Vancouver-AAM\\_white-paper-Sep2020.pdf](http://evtol.news/__media/news/NEXA-Vancouver-AAM_white-paper-Sep2020.pdf)
- CAAM. (2020b). *Economic Impacts of Advanced Air Mobility*. <https://static1.squarespace.com/static/586be5262994caa37cd4d217/t/5fb68fb7f45a5c4f7765abd2/1605799883745/Economic+Impacts+of+Advanced+Air+Mobility+-+New+Air+Mobility+Options+Will+Benefit+Vancouver%2C+Creating+Jobs+and+Energizing+Growth.pdf>
- Chan, W. N., Barmore, B. E., Kibler, J., Lee, P., O'Connor, N., Palopo, K., Thipphavong, D., & Zelinski, S. (2018, June 25). Overview of NASA's Air Traffic Management-eXploration (ATM-X) Project. *AIAA Aviation Forum*. <https://ntrs.nasa.gov/citations/20180005224>
- Chancey, E. T. (2020). *Effects of Concepts of Operation Factors on Public Acceptance and Intention to Use Urban Air Mobility (UAM) – Trust and Technology Acceptance Modeling*. [https://www.researchgate.net/profile/Eric-Chancey/publication/348190718\\_Effects\\_of\\_Concepts\\_of\\_Operation\\_Factors\\_on\\_Public\\_Acceptance\\_and\\_Intention\\_to\\_Use\\_Urban\\_Air\\_Mobility\\_UAM\\_Trust\\_and\\_Technology\\_Acceptance\\_Modeling/links/5ff330b692851c13feeb136c/Effects-of-Concepts-of-Operation-Factors-on-Public-Acceptance-and-Intention-to-Use-Urban-Air-Mobility-UAM-Trust-and-Technology-Acceptance-Modeling.pdf](https://www.researchgate.net/profile/Eric-Chancey/publication/348190718_Effects_of_Concepts_of_Operation_Factors_on_Public_Acceptance_and_Intention_to_Use_Urban_Air_Mobility_UAM_Trust_and_Technology_Acceptance_Modeling/links/5ff330b692851c13feeb136c/Effects-of-Concepts-of-Operation-Factors-on-Public-Acceptance-and-Intention-to-Use-Urban-Air-Mobility-UAM-Trust-and-Technology-Acceptance-Modeling.pdf)
- Cook, M. (2021, March 16). *Alphabets Oppose Proposed NYC Helipad Changes*. Aviation Publishing Group. <https://www.avweb.com/aviation-news/alphabets-oppose-proposed-nyc-helipad-changes/>
- Cotton, W. B. (2020). *Adaptive Airborne Separation to Enable UAM Autonomy in Mixed Airspace*. <https://ntrs.nasa.gov/api/citations/20200000700/downloads/20200000700.pdf>
- Crumley, B. (2021, May 14). *FAA readying tests of drone safety systems at five US airports*. DroneDJ. <https://dronedj.com/2021/05/14/faa-readying-tests-of-drone-safety-systems-at-five-us-airports/>
- Dao, Q. V., Homola, J., Cencetti, M., Mercer, J., & Martin, L. (2019, August 22). A Research Platform for Urban Air Mobility (UAM) and UAS Traffic Management (UTM) Concepts and Applications. *International Conference on Human Interaction & Emerging Technologies*. <https://ntrs.nasa.gov/citations/20190029574>

- Daskilewicz, M., German, B., Warren, M., Garrow, L. A., Boddupalli, S.-S., & Douthat, T. H. (2018). Progress in vertiport placement and estimating aircraft range requirements for eVTOL daily commuting. 2018 Aviation Technology, Integration, and Operations Conference. <https://doi.org/10.2514/6.2018-2884>
- Davies, M. (2020). *AAM Crosscutting Working Group: ISSA/IASMS ConOps Discussion*. NASA.
- Davies, M., & Patterson, M. (2020). *AAM Ecosystem Working Groups (AEWG): Urban Air Mobility (UAM) Concept of Operations (ConOps) Overview*.
- Dietrich, A. M. (2020a). *Components of Public Acceptance for AAM and UAM*. <https://www.communityairmobility.org/resourcefiles/components-of-public-acceptance-for-aam-and-uam>
- Dietrich, A. M. (2020b). *Advanced & Urban Air Mobility Impact and Timing*. <https://www.communityairmobility.org/resourcefiles/impact>
- Ellis, K., Koelling, J., Davies, M., & Krois, P. (2020). *In-time System-wide Safety Assurance (ISSA) Concept of Operations and Design Considerations for Urban Air Mobility (UAM)*. [https://nari.arc.nasa.gov/sites/default/files/attachments/ISSA.Conops.Final\\_.20.07.01.pdf](https://nari.arc.nasa.gov/sites/default/files/attachments/ISSA.Conops.Final_.20.07.01.pdf)
- European Union Aviation Safety Agency (EASA). (2021). *Study on the societal acceptance of Urban Air Mobility in Europe*. <https://www.easa.europa.eu/sites/default/files/dfu/uam-full-report.pdf>
- European Union Aviation Safety Agency (EASA). (2022). eVTOLs around the corner: the work of EASA's Drone Team. <https://www.easa.europa.eu/downloads/124029/en>
- FAA. (1991, May 31). Secondary navigation. AC 150/5390-3 (Cancelled) - Vertiport Design – Document Information. [https://www.faa.gov/airports/resources/advisory\\_circulars/index.cfm/go/document.information/documentNumber/150\\_5390-3](https://www.faa.gov/airports/resources/advisory_circulars/index.cfm/go/document.information/documentNumber/150_5390-3).
- FAA. (2020a). *FAA NextGen AAM Concept of Operations v1.0*. [https://nari.arc.nasa.gov/sites/default/files/attachments/UAM\\_ConOps\\_v1.0.pdf](https://nari.arc.nasa.gov/sites/default/files/attachments/UAM_ConOps_v1.0.pdf)
- FAA. (2020b). *Executive Summary: Final Rule on Remote Identification of Unmanned Aircraft (Part 89)*. [https://www.faa.gov/news/media/attachments/RemoteID\\_Executive\\_Summary.pdf](https://www.faa.gov/news/media/attachments/RemoteID_Executive_Summary.pdf)
- FAA. (2021, April 23). *UTM Pilot Program (UPP)*. [https://www.faa.gov/uas/research\\_development/traffic\\_management/utm\\_pilot\\_program/](https://www.faa.gov/uas/research_development/traffic_management/utm_pilot_program/)
- FAA. (2022, September 21). Engineering Brief No. 5, Vertiport Design. <https://www.faa.gov/sites/faa.gov/files/2022-09/eb-105-vertiports.pdf>.
- Fadhil, D. (2018). A GIS-based analysis for selecting ground infrastructure locations for urban air mobility. Technical University of Munich. [https://www.bgu.tum.de/fileadmin/w00blj/msm/theses/fadhil\\_2018.pdf](https://www.bgu.tum.de/fileadmin/w00blj/msm/theses/fadhil_2018.pdf).
- Fu, M., Rothfeld, R., & Antoniou, C. (2019). Exploring preferences for transportation modes in an urban mobility case study. SAGE Journals. <https://journals.sagepub.com/doi/abs/10.1177/0361198119843858>.

- Gawdiak, Y., Carr, G., & Hasan, S. (2012, June 14). JPDO case study of NextGen high density operations. *9th AIAA Aviation Technology, Integration, and Operations Conference (ATIO)*. <https://doi.org/10.2514/6.2009-6918>
- Ginn, S. (2019). *NASA Eco-System Working Group National Campaign Breakout Group Overview*. NASA. [https://nari.arc.nasa.gov/sites/default/files/attachments/NC Breakout Overview EcoWorkshop\\_v2\\_III\\_3\\_27.pdf](https://nari.arc.nasa.gov/sites/default/files/attachments/NC%20Breakout%20Overview%20EcoWorkshop_v2_III_3_27.pdf)
- Goodrich, K. (2020). *Automated Flight and Contingency Management, NASA Advanced Air Mobility (AAM) Project*. NASA. <https://ntrs.nasa.gov/citations/20205005773>
- Goodrich, K. H., & Theodore, C. R. (2021). Description of the NASA Urban Air Mobility Maturity Level (UML) Scale. *AIAA Scitech 2021 Forum*, 1–12. <https://doi.org/10.2514/6.2021-1627>
- Guan, X., Lyu, R., Shi, H., & Chen, J. (2020). A survey of safety separation management and collision avoidance approaches of civil UAS operating in integration national airspace system. *Chinese Journal of Aeronautics*, 33(11), 2851–2863. <https://doi.org/10.1016/j.cja.2020.05.009>
- Guerreiro, N. M., Hagen, G. E., Maddalon, J. M., & Butler, R. W. (2020, April 27). Capacity and Throughput of Urban Air Mobility Vertiports with a First-Come, First-Served Vertiport Scheduling Algorithm. *Aviation 2020 Conference*. <https://ntrs.nasa.gov/citations/20205001421>
- Haan, J., Garrow, L.A., Marzuoli, A., Roy, S., and B. M. (2021). Are Commuter Air Taxis Coming to Your City? A Ranking of 40 Cities in the United States. In *Georgia Institute of Technology*. <http://garrowlab.ce.gatech.edu/research/116>
- Hall, A. (2020). Urban Air Mobility (UAM) Operations Overview. In *Community Air Mobility Initiative (communityairmobility.org)*. [https://www.communityairmobility.org/s/UAMOperations\\_CAMI.pdf](https://www.communityairmobility.org/s/UAMOperations_CAMI.pdf)
- Hasan, S. (2019). *Urban Air Mobility (UAM) Market Study* (Issue November, pp. 108–147). NASA. <https://doi.org/10.4324/9781351212991-4>
- Hill, B. P., DeCarme, D., Metcalfe, M., Griffin, C., Wiggins, S., Metts, C., Bastedo, B., Patterson, M. D., & Mendonca, N. L. (2020). UAM Vision Concept of Operations (ConOps) UAM Maturity Level (UML) 4. In *NASA.gov*. <https://ntrs.nasa.gov/citations/20205011091>
- Hunter, G., & Wei, P. (2019). Service-Oriented Separation Assurance for Small UAS Traffic Management. *Integrated Communications, Navigation and Surveillance Conference (ICNS)*, 2G1-1-2G1-11. <https://doi.org/10.1109/ICNSURV.2019.8735165>
- iFlightPlanner. (2021). *Sectional layout with a proposed concept of the notional route from KDAB vertihub to KMCO vertihub* [Flight Plan]. iFlightPlanner. <https://www.iflightplanner.com/AviationCharts/?Map=sectional&GS=130&Route=FOLIG-GAMGY-UXFIM-28.7191/-81.0409-LOUKE-28.5492/-81.1805-COCAS-MINCO-28.5113/-81.3059-28.4464/-81.3073>
- Inrix. (2021, August 19). *Americans will waste \$2.8 trillion on traffic by 2030 if gridlock persists*. Inrix. <https://inrix.com/press-releases/americans-will-waste-2-8-trillion-on-traffic-by-2030-if-gridlock-persists/>.

- Kahne, S., & Frolow, I. (1996, August). Air Traffic Management: Evolution With Technology. *IEEE Control Systems Magazine*, 16(4), 12–21. <https://doi.org/10.1109/37.526911>
- Kleczatský, A., Hulínská, Š., & Kraus, J. (2020). The Role of CIS in the U-space Environment. *MAD - Magazine of Aviation Development*, 8(2), 6–10. <https://doi.org/10.14311/mad.2020.02.01>
- Kloss, B., & Riedel, R. (2021, June 1). *How do consumers view advanced air mobility?* <https://www.mckinsey.com/industries/aerospace-and-defense/our-insights/up-in-the-air-how-do-consumers-view-advanced-air-mobility?cid=other-eml-dre-mip-mck&hlkid=89c609eb3f584a05b21acbe01ebf73c3&hctky=12584247&hdpid=094d27ac-06c5-4319-b8f6-edbb27b2bcd#>
- Kopardekar, P., Rios, J., Prevot, T., Johnson, M., Jung, J., & Robinson III, J. E. (2016, June 10). UAS Traffic Management (UTM) Concept of Operations to Safely Enable Low Altitude Flight Operations. *16th AIAA Aviation Technology, Integration, and Operations Conference*. <https://doi.org/10.2514/6.2016-3292>
- Kotwicz Herniczek, M. T., Garbo, A., Lau, M., German, B. J., & Garrow, L. A. (2019). Exploration of near-term urban air mobility operations with retrofitted electric general aviation aircraft. *AIAA Aviation 2019 Forum, June*, 1–18. <https://doi.org/10.2514/6.2019-2872>
- Kunchulia, A., Edwards, T., Hasan, S., & Price, G. (2019). Urban air mobility minimum viable product. *AIAA Aviation 2019 Forum, June*, 1–16. <https://doi.org/10.2514/6.2019-2874>
- Lacher, A. (2020). *Thoughts on AAM Routes (aka Corridors)* (pp. 1–9). Boeing/NASA. [https://nari.arc.nasa.gov/sites/default/files/attachments/AAM Routes - NASA AEWG - September 1st-Boeing-FINAL\\_0.pdf](https://nari.arc.nasa.gov/sites/default/files/attachments/AAM%20Routes%20-%20NASA%20AEWG%20-%20September%201st-Boeing-FINAL_0.pdf)
- Lascara, B., Lacher, A., DeGarmo, M., Maroney, D., Niles, R., & Vempati, L. (2019). *Urban Air Mobility Airspace Integration Concepts: Operational Concepts and Exploration Approaches*. <https://www.mitre.org/sites/default/files/publications/pr-19-00667-9-urban-air-mobility-airspace-integration.pdf>
- Li, J., Zhu, Z., & Cheng, Y. (2021). *Research and Development of General Coverage Analysis Model for Air Traffic Control Stations*. 914–919. <https://doi.org/10.1109/iccasi50869.2020.9368867>
- Lilium. (2020, July 14). *Designing a scalable vertiport*. Lilium. <https://lilium.com/newsroom-detail/designing-a-scalable-vertiport>.
- Lim, E., & Hwang, H. (2019). The selection of vertiport location for on-demand mobility and its application to Seoul metro area. *International Journal of Aeronautical and Space Sciences*, 20(1), 260–272. <https://doi.org/10.1007/s42405-018-0117-0>
- Lin, C. E., & Shao, P. C. (2020). Development of Hierarchical UAS Traffic Management (UTM) in Taiwan. *Journal of Physics: Conference Series*, 1509, 12012. <https://doi.org/10.1088/1742-6596/1509/1/012012>
- Lin Tan, L. K., Lim, B. C., Park, G., Low, K. H., & Seng Yeo, V. C. (2021). Public acceptance of drone applications in a highly urbanized environment. *Technology in Society*, 64, 101462. <https://doi.org/10.1016/j.techsoc.2020.101462>

- Lin, Y.-H., Lin, C. E., & Chen, H.-C. (2020). ADS-B Like UTM Surveillance Using APRS Infrastructure. *Aerospace*, 7(7), 100. <https://doi.org/10.3390/aerospace7070100>
- Lineberger, R., Hussain, A., & Silver, D. (2021). *Advanced Air Mobility: Can the United States Afford to Lose the Race?* <https://www2.deloitte.com/us/en/insights/industry/aerospace-defense/advanced-air-mobility.html>
- Liu, Z., Cai, K., & Zhu, Y. (2021). Civil unmanned aircraft system operation in national airspace: A survey from Air Navigation Service Provider perspective. *Chinese Journal of Aeronautics*, 34(3), 200–224. <https://doi.org/10.1016/j.cja.2020.08.033>
- Loon. (2020). *Learnings from human-automation teaming for safe and sublinear scale operations*. NASA. [https://nari.arc.nasa.gov/sites/default/files/attachments/NASA UAM - Loon %281%29.pdf](https://nari.arc.nasa.gov/sites/default/files/attachments/NASA%20UAM%20-%20Loon%20-%20Final%20-%2020200829.pdf)
- Lowry, R. (2022). "Wilcoxon Signed-Rank Test." <http://vassarstats.net/textbook/ch12a.html>
- McCarthy, T., Pforte, L., & Burke, R. (2020). Fundamental Elements of an Urban UTM. *Aerospace*, 7(7), 85. <https://doi.org/10.3390/aerospace7070085>
- Mendonca, N. L. (2020). *AAM Community Integration Working Group Kickoff*. NASA. <https://ntrs.nasa.gov/citations/20205002327>
- Mid-Florida Marketing & Research, Inc. (2021). Quarterly visitor profile April – May – June 2021. Halifax Area Advertising Authority. [https://assets.simpleviewinc.com/simpleview/image/upload/v1/clients/daytonabeach/Quarterly\\_Visitor\\_Profile\\_April\\_June\\_2021\\_38e5cbc6-2dff-4352-99f9-c6b056cf694b.pdf](https://assets.simpleviewinc.com/simpleview/image/upload/v1/clients/daytonabeach/Quarterly_Visitor_Profile_April_June_2021_38e5cbc6-2dff-4352-99f9-c6b056cf694b.pdf)
- Moeckel, R., Kuehnel, N., Llorca, C., Moreno, A. T., & Rayaprolu, H. (2020). Agent-based simulation to improve policy sensitivity of trip-based models. *Journal of Advanced Transportation*, 2020, 1–13. <https://doi.org/10.1155/2020/1902162>
- Moore, M. D., Goodrich, K., Viken, J., Smith, J., Fredericks, B., Trani, T., Barraclough, J., German, B., & Patterson, M. (2013). High-speed mobility through on-demand aviation. *2013 Aviation Technology, Integration, and Operations Conference*. <https://doi.org/10.2514/6.2013-4373>
- Morgan Stanley Research. (2021). *eVTOL/Urban Air Mobility TAM Update: A Slow Take-Off, But Sky's the Limit*.
- Mueller, E., Kopardekar, P., & Goodrich, K. (2017, June 5). Enabling airspace integration for high-density on-demand mobility operations. *17th AIAA Aviation Technology, Integration, and Operations Conference*. <https://doi.org/10.2514/6.2017-3086>
- NASA. (2020a). *AAM Ecosystem Airspace WG: Initial UAM Concept of Operations V1.0*. NASA. [https://nari.arc.nasa.gov/sites/default/files/attachments/AAMWG-Airspace August4-2020\\_IL.pdf](https://nari.arc.nasa.gov/sites/default/files/attachments/AAMWG-Airspace%20August4-2020_IL.pdf)
- NASA. (2020b). *NASA Advanced Air Mobility (AAM) Project Vertiport Terminology Discussion*. NASA.
- NASA. (2020c). *NASA Advanced Air Mobility (AAM) Vertiport Automation Trade Study*. NASA. [https://ntrs.nasa.gov/api/citations/20210009757/downloads/20210009757\\_MAJohnson\\_VertiportTradeStudy\\_final.pdf](https://ntrs.nasa.gov/api/citations/20210009757/downloads/20210009757_MAJohnson_VertiportTradeStudy_final.pdf)

- NASA. (2020d). “TLX @ NASA Ames.” <https://humansystems.arc.nasa.gov/groups/tlx/>
- NASA. (2022) “NASA TLX App.” <https://humansystems.arc.nasa.gov/groups/tlx/tlxapp.php>
- National Academies of Sciences, E. and M. (2020). Advancing Aerial Mobility: A National Blueprint. In *Advanced Aerial Mobility*. The National Academies Press. <https://doi.org/10.17226/25646>
- Nguyen, T. Van. (2020). Dynamic Delegated Corridors and 4D Required Navigation Performance for Urban Air Mobility (UAM) Airspace Integration. *Journal of Aviation/Aerospace Education & Research*, 29(2), 57–72. <https://doi.org/10.15394/jaaer.2020.1828>
- Niklaß, M., Dzikus, N., Swaid, M., Berling, J., Lührs, B., Lau, A., Terekhov, I., & Gollnick, V. (2020). A Collaborative Approach for an Integrated Modeling of Urban Air Transportation Systems. *Aerospace*, 7(50). <https://doi.org/10.3390/aerospace7050050>
- Northeast UAS Airspace Integration Research Alliance (NUAIR). (2021). *High-Density automated Vertiport concept of operations - NASA technical reports SERVER (NTRS)*. NASA. <https://ntrs.nasa.gov/citations/20210016168>.
- Nurden, A., O.K. Rahma, R. A., & Ismail, A. (2007). Effect of transportation policies on modal shift from private car to public transport in Malaysia. *Journal of Applied Sciences*, 7(7), 1013–1018. <https://doi.org/10.3923/jas.2007.1013.1018>
- Panel, T. (2018). *5Th annual VTOL VFS - 5th Annual Transformative VTOL Workshop*. <http://vtol.org/news/5th-annual-transformative-vtol-workshop>.
- Patterson, M. D., Antcliff, K. R., & Kohlman, L. W. (2018, May 14). A Proposed Approach to Studying Urban Air Mobility Missions Including an Initial Exploration of Mission Requirements. *Annual Forum and Technology Display*. <https://ntrs.nasa.gov/citations/20190000991>
- Patterson, M. D., Isaacson, D. R., Mendonca, N. L., Neogi, N. A., Goodrich, K. H., Metcalfe, M., Bastedo, B., Metts, C., Hill, B. P., Decarme, D., Griffin, C., & Wiggins, S. (2021). An initial concept for intermediate-state, passenger-carrying urban air mobility operations. *AIAA Scitech 2021 Forum*, 1–22. <https://doi.org/10.2514/6.2021-1626>
- Perry, D. (2021, May 4). *Textron to take time over eVTOL development as batteries ‘not yet ready.’* Flight Global. <https://www.flightglobal.com/aerospace/textron-to-take-time-over-evtol-development-as-batteries-not-yet-ready/143590.article>
- Polek, G. (2021). *Airlines Back Vertical with Largest eVTOL Aircraft Deal So Far*. AIN Online. [https://www.ainonline.com/aviation-news/air-transport/2021-06-10/airlines-back-vertical-largest-evtol-aircraft-deal-so-far?utm%5C\\_hsid=29562862&utm%5C\\_campaign=AINAlerts&utm%5C\\_medium=email&%5C\\_hsmi=133177634&%5C\\_hsenc=p2ANqtz-%5C\\_GK-1vpXOiCSINQ19K0Ou93WgMOYpiYWQTYMBviWYao2gOx7vLHSlStB5X9rVq21s8PDNCAQ3BmsctQrXU1Wc6SMbYyQ&utm%5C\\_content=2&utm%5C\\_source=hs%5C\\_email](https://www.ainonline.com/aviation-news/air-transport/2021-06-10/airlines-back-vertical-largest-evtol-aircraft-deal-so-far?utm%5C_hsid=29562862&utm%5C_campaign=AINAlerts&utm%5C_medium=email&%5C_hsmi=133177634&%5C_hsenc=p2ANqtz-%5C_GK-1vpXOiCSINQ19K0Ou93WgMOYpiYWQTYMBviWYao2gOx7vLHSlStB5X9rVq21s8PDNCAQ3BmsctQrXU1Wc6SMbYyQ&utm%5C_content=2&utm%5C_source=hs%5C_email)

- Pongsakornsathien, N., Bijjahalli, S., Gardi, A., Sabatini, R., & Kistan, T. (2020). A Novel Navigation Performance-based Airspace Model for Urban Air Mobility. *AIAA/IEEE 39th Digital Avionics Systems Conference (DASC), 2020-October*. <https://doi.org/10.1109/DASC50938.2020.9256686>
- Poole, R. (2021, May 21). *Aviation Policy News: Remote Towers, Passenger Facility Charges, and More*. Aviation Policy News, Reason Foundation. <https://reason.org/aviation-policy-news/aviation-policy-news-remote-towers-passenger-facility-charges-and-more/>
- Preis, L. (2021, July 28). *Quick sizing, throughput estimating and layout planning for VTOL aerodromes – a methodology for vertiport design: AIAA aviation 2021 forum*. AIAA Aviation Forum. <https://arc.aiaa.org/doi/10.2514/6.2021-2372>.
- Prevot, T. (2020). *Operations Inside Corridors*. Uber Elevate.
- Rajendran, S., & Zack, J. (2019). Insights on strategic air taxi network infrastructure locations using an iterative constrained clustering approach. *Transportation Research Part E: Logistics and Transportation Review*, 128, 470–505. <https://doi.org/10.1016/j.tre.2019.06.003>
- Raju, P., Rios, J., & Jordan, A. (2018). UTM — A complementary set of services to ATM. *2018 Integrated Communications, Navigation, Surveillance Conference (ICNS), 2F2-1-2F1-7*. <https://doi.org/10.1109/ICNSURV.2018.8384849>
- Ramasamy, S., Sabatini, R., & Gardi, A. (2016a) A unified approach to separation assurance and collision avoidance for flight management systems. *IEEE/AIAA 35th Digital Avionics Systems Conference (DASC)* <https://doi.org/10.1109/DASC.2016.7777964>
- Ramasamy, S., Sabatini, R., (2016b, September). Automated Separation Assurance and Collision Avoidance Functuations in the CNS+A Context. *30th Congress of the International Council of the Aeronautical Sciences*. [https://www.icas.org/ICAS\\_ARCHIVE/ICAS2016/data/papers/2016\\_0027\\_paper.pdf](https://www.icas.org/ICAS_ARCHIVE/ICAS2016/data/papers/2016_0027_paper.pdf)
- Ramasamy, S., Sabatini, R., & Gardi, A. (2017). A Unified Approach to Separation Assurance and Collision Avoidance for UAS Operations and Traffic Management. *International Conference on Unmanned Aircraft Systems (ICUAS)*, 920–928. <https://doi.org/10.1109/ICUAS.2017.7991523>
- Rath, S., & Chow, J. Y. J. (2019, April 1). *Air taxi skyport location problem for airport access*. arXiv.org. <https://arxiv.org/abs/1904.01497v1>.
- Rios, J. L., Smith, I. S., Venkatesan, P., Smith, D. R., Baskaran, V., Jurcak, S., Iyer, S., & Verma, P. (2018). *UTM UAS Service Supplier Development Sprint 2 Toward Technical Capability Level 4*. <https://ntrs.nasa.gov/citations/20180008453>
- Rios, J. L., Smith, I. S., Venkatesan, P., Homola, J. R., Johnson, M. A., & Jung, J. (2019). *UAS Service Supplier Specification: Baseline requirements for providing USS services within the UAS Traffic Management System*. <https://ntrs.nasa.gov/citations/20200000512>
- Roche, C., Oakes, S., Bender, K., Magyarits, S., & Homola, J. R. (2018). *Cover Letter UTM RTT CWG Concept & Use Cases Package #2*. <https://ntrs.nasa.gov/api/citations/20190004908/downloads/20190004908.pdf>

- Rollo, M., Selecký, M., & Volf, P. (2017). Simulation of UAS integration into shared airspace for validation of impact on ATM systems. *Integrated Communications, Navigation and Surveillance Conference, ICNS*, 6D2-1-6D2-7. <https://doi.org/10.1109/ICNSURV.2017.8012024>
- Rothfeld, R. L., Balac, M., Ploetner, K. O., & Antoniou, C. (2018, June 24). Initial Analysis of Urban Air Mobility's Transport Performance in Sioux Falls. *Aviation Technology, Integration, and Operations Conference*. <https://doi.org/10.2514/6.2018-2886>
- Rothfeld, R., Fu, M., Balać, M., & Antoniou, C. (2021). Potential urban air mobility travel time savings: an exploratory analysis of Munich, Paris, and San Francisco. *Sustainability*, 13(4), 2217. <https://doi.org/10.3390/su13042217>
- Sacharny, D., Henderson, T. C., Cline, M., Russon, B., & Guo, E. J. (2020). FAA-NASA vs. Lane-Based Strategic Deconfliction. *IEEE International Conference on Multisensor Fusion and Integration for Intelligent Systems, 2020-September*, 13–18. <https://doi.org/10.1109/MFI49285.2020.9235239>
- Sampson, B. (2021, May 6). *Alia eVTOL receives US Air Force airworthiness approval*. Aerospace Testing International. <https://www.aerospacetestinginternational.com/news/electric-hybrid/alia-evtol-receives-us-air-force-airworthiness-approval.html>
- Sengupta, R., Waddell, P., Yedavalli, P., Onat, E. B., Peng, X., Xue, M., & Bulusu, V. (n.d.). *Multi-Modal Mobility Study: Integrating Ground and Air*. Berkeley University of California/NASA.
- Sheth, K. (2021). *Regional Modeling and Simulation for Vertiport Location Assessment*. <https://aam-cms.marqui.tech/uploads/aam-portal-cms/originals/161ad529-b338-40f8-ad6e-683f0c4578dd.pdf>
- Stansbury, R. S., Gillespie, R., Robbins, J., & Geraci, M. (2019, January 6). Assessment of the impact of maintenance-induced failures on unmanned aircraft systems to operations in National Airspace System. *AIAA Scitech 2019 Forum*. <https://doi.org/10.2514/6.2019-1786>
- Stith, P., & Khangura, J. (2020). Preparing for Take-Off: Urban Air Mobility Infrastructure National Institute of Aerospace (NIA) National Aeronautics and Space Administration (NASA) Study Results. *33rd World Electric Vehicle Symposium & Exposition (EVS33) Peer Reviewed Conference Papers*, 1–10. <https://doi.org/10.5281/zenodo.4027893>
- Stouffer, V. L., Cotton, W. B., DeAngelis, R. A., Devasirvatham, D. M., Irvine, T. B., Jennings, R. E., Lehmer, R. D., Nguyen, T. C., & Shaver, M. (2020). *Reliable, Secure, and Scalable Communications, Navigation, and Surveillance (CNS) Options for Urban Air Mobility (UAM)*. [https://ntrs.nasa.gov/api/citations/20205006661/downloads/UAM CNS Final Report 80GRC019D0017 with App A B C v2.pdf](https://ntrs.nasa.gov/api/citations/20205006661/downloads/UAM%20CNS%20Final%20Report%2080GRC019D0017%20with%20App%20A%20B%20C%20v2.pdf)
- Syed, N., Rye, M., Ade, M., Trani, A., Hinze, N., Swingle, H., Smith, J. C., Marien, T., & Dollyhigh, S. (2017). Preliminary Considerations for ODM Air Traffic Management based on Analysis of Commuter Passenger Demand and Travel Patterns for the Silicon Valley Region of California. *17th AIAA Aviation Technology, Integration, and Operations Conference*, June, 1–20. <https://doi.org/10.2514/6.2017-3082>



- Thippavong, D. P., Apaza, R. D., Barmore, B. E., Battiste, V., Belcastro, C. M., Burian, B. K., Dao, Q. V., Feary, M. S., Go, S., Goodrich, K. H., Homola, J. R., Idris, H. R., Kopardekar, P. H., Lachter, J. B., Neogi, N. A., Ng, H. K., Oseguera-Lohr, R. M., Patterson, M. D., & Verma, S. A. (2018, June 24). Urban Air Mobility Airspace Integration Concepts and Considerations. *Aviation Technology, Integration, and Operations Conference*.  
<https://doi.org/10.2514/6.2018-3676>
- Tuchen, S., Leiden, K., & Bagnall, T. (2020). Multimodal Transportation Operational Scenario and Conceptual Data Model for Integration with UAM. *Integrated Communications Navigation and Surveillance Conference (ICNS)*, 2C1-1-2C1-15.  
<https://doi.org/10.1109/ICNS50378.2020.9223002>
- Tyrinopoulos, Y., & Antoniou, C. (2012). Factors affecting modal choice in urban mobility. *European Transport Research Review*, 5(1), 27–39. <https://doi.org/10.1007/s12544-012-0088-3>
- Uber Elevate. (2016). Fast-forwarding to a future of on-demand urban air transportation. eVTOL News. [https://evtol.news/\\_\\_media/PDFs/UberElevateWhitePaperOct2016.pdf](https://evtol.news/__media/PDFs/UberElevateWhitePaperOct2016.pdf)
- UK Research and Innovation (UKRI). (2021). Future Flight Vision and Roadmap August 2021. UKRI. <https://www.ukri.org/publications/future-flight-vision-and-roadmap/>
- Vascik, P. D., & Hansman, R. J. (2020). Allocation of airspace cutouts to enable procedurally separated small aircraft operations in terminal areas. *AIAA Aviation 2020 Forum, 1 Part F*.  
<https://doi.org/10.2514/6.2020-2905>
- Vascik, P. D., & Hansman, R. J. (2017). Evaluation of key operational constraints affecting on demand mobility for aviation in the Los Angeles basin: Ground infrastructure, air traffic control and noise. *17th AIAA Aviation Technology, Integration, and Operations Conference*, 1–20. <https://doi.org/10.2514/6.2017->
- Vascik, P. D., Balakrishnan, H., & Hansman, R. J. (2018a, September 10). *Assessment of air traffic control for urban air mobility and unmanned systems*. Assessment of Air Traffic Control for Urban Air Mobility and Unmanned Systems.  
<https://dspace.mit.edu/handle/1721.1/117686>
- Vascik, P. D., Hansman, R. J., & Dunn, N. S. (2018b). Analysis of urban air mobility operational constraints. *Journal of Air Transportation*, 26(4), 133–146. <https://doi.org/10.2514/1.D0120>
- Verma, S. A., Monheim, S. C., Moolchandani, K. A., Pradeep, P., Cheng, A. W., Thippavong, D. P., Dulchinos, V. L., Arneson, H., Lauderdale, T. A., Bosson, C. S., Mueller, E. R., & Wei, B. (2020). *Lessons Learned: Using UTM Paradigm for Urban Air Mobility Operations*.  
<https://doi.org/10.1109/DASC50938.2020.9256650>
- Vilar Llidó, M. (2018). *Evaluation of Urban Air Mobility Systems Considering Regulatory and Operational Constraints* [RWTH Aachen University].  
<https://riunet.upv.es/handle/10251/143387>
- Volf, P. (2017). Simulation of UAS Integration into Shared Airspace for Validation of Impact on ATM Systems. *International Communication, Navigation, and Surveillance (ICNS) Conference*.

- Volocopter. (2021). *The Roadmap to scalable urban air mobility*.  
[https://www.volocopter.com/content/uploads/20210324\\_Volocopter\\_WhitePaper\\_Roadmap\\_to\\_scalable\\_UAM\\_m.pdf](https://www.volocopter.com/content/uploads/20210324_Volocopter_WhitePaper_Roadmap_to_scalable_UAM_m.pdf)
- Wang, F., & Ross, C. L. (2017). New potential for multimodal connection: exploring the relationship between taxi and transit in New York City (NYC). *Transportation*, 46(3), 1051–1072. <https://doi.org/10.1007/s11116-017-9787-x>
- Warwick, G. (2021a, May 7). *Morgan Stanley Expects Slower Start To UAM Market*. Aviation Week Network. <https://aviationweek.com/air-transport/aircraft-propulsion/morgan-stanley-expects-slower-start-uam-market>
- Warwick, G. (2021b, May 17). *Volocopter Goes Bigger, Faster, Farther With VoloConnect eVTOL*. Aviation Week Network. <https://aviationweek.com/business-aviation/aircraft-propulsion/volocopter-goes-bigger-faster-farther-voloconnect-evtol>
- Willey, L. C., & Salmon, J. L. (2021). A method for urban air mobility network design using hub location and subgraph isomorphism. *Transportation Research Part C: Emerging Technologies*, 125, 102997. <https://doi.org/10.1016/j.trc.2021.102997>
- Wing, D. J., & Levitt, I. M. (2020). *New Flight Rules to Enable the Era of Aerial Mobility in the National Airspace System*. <https://ntrs.nasa.gov/citations/20205008308>
- Wisk. (2021, September). From airports to mobility hubs: Leveraging existing infrastructure for AAM. Wisk Aero. [https://wisk.aero/wp-content/uploads/2021/09/Wisk\\_AirportsForAAM\\_Whitepaper\\_final.pdf](https://wisk.aero/wp-content/uploads/2021/09/Wisk_AirportsForAAM_Whitepaper_final.pdf)
- Wu, Z., & Zhang, Y. (2021). Integrated network design and Demand forecast for On-demand urban Air Mobility. *Engineering*, 7(4), 473–487. <https://doi.org/10.1016/j.eng.2020.11.007>
- Yang, X., & Wei, P. (2020). Scalable Multi-Agent Computational Guidance with Separation Assurance for Autonomous Urban Air Mobility. *Journal of Guidance, Control, and Dynamics*, 43(8), 1473–1486. <https://doi.org/10.2514/1.G005000>
- Yedavalli, P., & Mooberry, J. (2019). *An Assessment of Public Perception of Urban Air Mobility (UAM)*.  
[https://storage.googleapis.com/blueprint/AirbusUTM\\_Full\\_Community\\_PerceptionStudy.pdf](https://storage.googleapis.com/blueprint/AirbusUTM_Full_Community_PerceptionStudy.pdf)
- Young, R. (2020). UTM Evolution Into the 2020S – New York as a Case Study. *2020 Integrated Communications Navigation and Surveillance Conference (ICNS)*, 2D3-1-2D3-18.  
<https://doi.org/10.1109/ICNS50378.2020.9223007>
- Young, S., Ancel, E., Moore, A., Dill, E., Quach, C., Foster, J., Darafsheh, K., Smalling, K., Vazquez, S., Evans, E., Okolo, W., Corbetta, M., Ossenfort, J., Watkins, J., Kulkarni, C., & Spirkovska, L. (2020). *Architecture and Information Requirements to Assess and Predict Flight Safety Risks During Highly Autonomous Urban Flight Operations*.  
<https://ntrs.nasa.gov/citations/20200001140>
- Zapico, J. M., Crossley, W. A., & Sun, D. (2021). Assessing potential urban air mobility traffic density in a metropolitan area like Chicago. *AIAA Scitech 2021 Forum, January*, 1–21.  
<https://doi.org/10.2514/6.2021-1628>

- Zhou, J. (2012). Sustainable commute in a car-dominant city: Factors affecting alternative mode choices among university students. *Transportation Research Part A: Policy and Practice*, 46(7), 1013–1029. <https://doi.org/10.1016/j.tra.2012.04.001>
- Zhu, G., & Wei, P. (2019). Pre-Departure Planning for Urban Air Mobility Flights with Dynamic Airspace Reservation. *AIAA Aviation 2019 Forum*, 1–11. <https://doi.org/10.2514/6.2019-3519>
- Zippia. (2022) "Air Traffic Controller Demographics and Statistics in the US." <https://www.zippia.com/air-traffic-controller-jobs/demographics/>

#### 4.9 Appendix A: Literature Review

The team produced a literature review as its first deliverable for A36's Working Package #3. A copy of the literature review, updated July 2022, can be found as **A36-WP3-Attachment-A-Literature Review.pdf**. The attachment is embedded to the report below.



A36-WP3-Attachme  
nt-A- Literature Revi

#### 4.10 Appendix B: Institutional Review Board Materials

Prior to conducting experiments under working package #3, the team submitted an Institution Review Board (IRB) human subject research application. The research was approved by the IRB as expedited. The acceptance letter and application materials are attached as **A36-WP3-Appendix-B-IRB-Application-and-Acceptance.pdf**. The attachment is embedded to the report below.



A36-WP3-Attachme  
nt-B-IRB-Application